



Westinghouse



CORDLESS VACUUM CLEANER INSTRUCTION MANUAL

29.6V

300W

WHVCSV04SB



CONTENTS

SAFETY INFORMATION

Important Safety Instructions..... 1 - 2

SETUP AND USE

Parts and Features..... 3

Damage Prevention & Warnings.....4

Preparing the Vacuum Cleaner..... 5

Install and Charge of Battery pack 5

Assembling the Vacuum Cleaner.....6

Operation.....7

CLEANING AND CARE8 - 9

TROUBLESHOOTING 10

WARRANTY 11 - 12

Figures and illustrations in this User Manual are provided for reference only and may differ from actual product appearance.

Product design and specifications may be changed without notice.

IMPORTANT SAFETY INSTRUCTIONS

WARNING

Read all instructions before using this appliance.

1. This vacuum cleaner is specifically designed for household purposes. Please do not use for commercial or industrial purposes.
2. Always turn the power off at the power outlet before you remove or insert the power plug. Remove by grasping the plug - do not pull on the cord.
3. To reduce the risk of electric shock, do not use outdoors or on wet surfaces.
4. Do not operate the vacuum cleaner if:
 - i) the cord or plug is split, melted or damaged.
 - ii) the vacuum cleaner has malfunctioned.
 - iii) the vacuum cleaner has been damaged in any manner.
 - iiii) the vacuum cleaner has been exposed to water or left outdoors.

If any of the above incidents occur, return your vacuum cleaner to the nearest authorised service center for examination, repair or adjustment.

5. Do not handle the A/C plug or vacuum cleaner with wet hands.
6. Do not place any objects into vents or openings in the vacuum cleaner. Do not use with vents or openings blocked. Keep free of dust, lint, hair and anything that may reduce the airflow to the vacuum cleaner.
7. Keep hair, loose clothing, fingers and all parts of body away from openings and moving parts.
8. Turn all controls off before unplugging.
9. Use extra care when cleaning stairs.
10. This appliance is deemed for use indoors only.
11. Do not use to pick up flammable or combustible liquids, such as detergent, chlorine, bleach, kerosene, gasoline, glass waste, needles, cigarette ash, moisturised dust, sewage, matches, drain cleaner and similar articles or use in areas where they may be present.
12. Do not use the vacuum cleaner to suck cement, gypsum powder, plaster powder and similar small particles, or toy paper fillers and other larger objects, which can cause vacuum cleaner clogging, motor burnout and additional faults.
13. Do not use the vacuum cleaner near fire sources or other high temperature environments.
14. Do not under any circumstances immerse the power cord, mains plug or vacuum cleaner body in water or any other liquid.
15. Ensure filters and turbo brush are cleaned regularly. Please check before each use to avoid blockages which may cause motor damage. Cleaning of filters and turbo brush regularly will ensure optimum operation and longevity. Monthly cleaning recommended.

IMPORTANT SAFETY INSTRUCTIONS

16. This appliance is not intended for use by persons (including children) with reduced physical, sensory or mental capabilities, or lack of experience and knowledge, unless they have been given supervision or instruction by a responsible person concerning use of the appliance to ensure that they can use it safely
17. Children should be supervised to ensure that they do not play with the appliance.
18. Keep the vacuum cleaner out of the reach of children under 12 years of age.
19. Do not splash or vacuum up water or other liquids into the machine to avoid short-circuit and burn-out.
20. After washing the filters, ensure the filters are completely dry before reinserting and operating the vacuum cleaner to avoid short circuit and possible damage.
21. Always charge this appliance with a power outlet of the voltage (AC only), marked on the rating label of the vacuum cleaner.
22. Do not use the vacuum cleaner for any purpose other than its intended use.
23. Do not use the vacuum cleaner without filters in place.
24. Cleaning and user maintenance should not be made by children without supervision.
25. Use the original provided battery with the appliance only.
26. Always empty the dust bin and clean the filters after vacuuming carpets, fresheners, powders and fine dust. These products can clog the filters, reduce airflow and can ultimately cause damage to the vacuum cleaner. Failure to do so could cause permanent damage to the Vacuum cleaner.
27. Neither Westinghouse nor the retailer can accept any liability for damage to the product or personal injury resulting due to failure to observe the warnings and procedures included in this instruction manual.
28. This appliance includes Li-ion batteries, do not incinerate or expose them to high temperature, as they may explode.
29. Leaks from the battery or battery cells can occur under extreme conditions. Do not touch any liquid that leaks from the battery. If the liquid makes contact with skin, wash immediately with soap and water. If the liquid gets into the eyes, flush them immediately with clean water for a minimum of 10 minutes and seek medical attention. Wear gloves to handle the battery and dispose of immediately in accordance with local regulations.
30. When a new battery is used for the first time or charged after long-term storage, fully charge the battery. When the device is stored and not used for long periods of time, ensure that the battery pack is fully charged. Ensure that the battery is charged and discharged at least once every three months.
31. Avoid contact between the battery and small metallic objects such as paper clips, coins, keys, nails or screws.
32. Never immerse the vacuum cleaner body or accessories in water or any other liquid. (Filter assembly and fine particle filter excluded. Refer Cleaning and Care on page 8)

DAMAGE PREVENTION & WARNINGS

NOTE: Switch off the vacuum cleaner immediately if the air intake, the floor brush or the telescope tube becomes blocked. Before switching the vacuum cleaner on again, remove the substance causing the blockage.

1. Never use the vacuum cleaner in the immediate vicinity of hot bodies and do not vacuum hot objects such as cigarette ends or ashes.

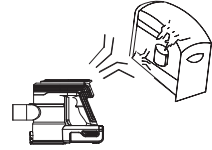

2. Ensure your hands are dry before handling the power cable, vacuum cleaner or plugging into a mains socket.

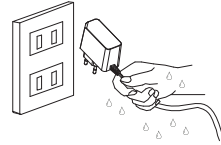

3. Remove large or sharp objects from the floor before using the vacuum cleaner to avoid any potential damage or blocking of the appliance.

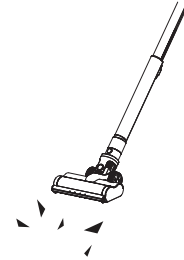

4. When unplugging from the mains power supply, pull by the plug only. Do not pull on the power cord.

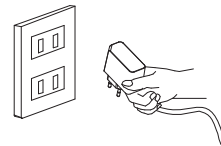

PREPARING THE VACUUM CLEANER

1. Carefully unpack your cordless vacuum cleaner.
2. Remove packaging around the vacuum cleaner, power cord and AC plug. Do not remove warning labels.
3. Lay all components out on the floor ready for assembly.

INSTALL & CHARGE OF BATTERY PACK

When the vacuum cleaner power is insufficient or the vacuum cleaner is being charged for the first time, please fully charge the vacuum cleaner battery. The battery can be charged in 2 different ways. It can be charged directly through the handheld vacuum cleaner (the battery capacity indicator will indicate the state of the battery) or the battery can be removed and charged separately. Please remember to charge the battery after each cleaning session or when the battery is low.

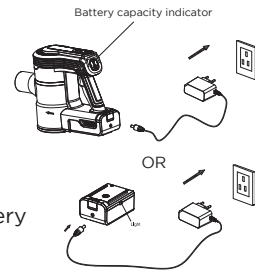

1. Charging the battery separately:

Plug the charger cable into the power inlet located on the back of the battery and the charger plug into the power socket. When charging, the energy indicator light will illuminate RED. Once fully charged this indicator light will change to BLUE. Once fully charged, turn the charger cable plug off at the power socket and remove the charger cable from the battery. Slide the battery into the vacuum cleaner body. The vacuum cleaner is now ready for use.

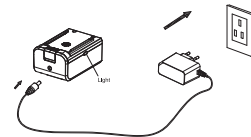

1. Charging the battery through the vacuum cleaner:

Slide the battery into the vacuum cleaner body. Plug the charger cable into the power inlet located on the back of the battery and the charger plug into the power socket. When there is little or no battery power, the three battery capacity indicator lights will emit a flickering light. Whilst charging, the number of lights will illuminate one by one indicating the charge level. Two lights illuminated indicates the battery is 50% charged and three lights indicates 100% charged. Once fully charged, turn the charger cable plug off at the power socket and remove the charger cable from the battery. The vacuum cleaner is now ready for use.

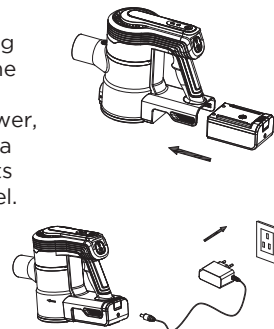

Note: The total charging time is about 4-5hours.

ASSEMBLING THE VACUUM CLEANER

1. Before assembling the vacuum cleaner, mount the included wall-mounted storage unit to the wall. Ensure it is mounted high enough to allow the vacuum cleaner to rest on the wall-mount at full height.

Place the mount against the wall and using the wall unit mounting holes as a guide, mark the wall where the wall plugs (brick only) will be drilled and inserted. Drill holes into the wall and insert the wall plugs. Line up the wall-mount unit holes with the drilled inserted plugs and insert the screws into the wall plugs. Tighten using a Philips head screw driver. (Drywall fixings not supplied)

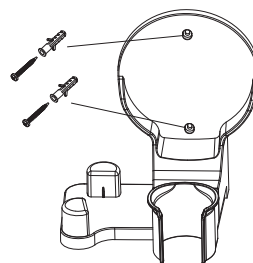

2. Once fully charged, slide the battery into the vacuum cleaner body. When successfully installed, the battery will "click" into place.

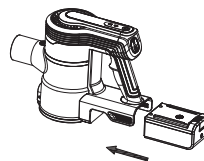

3. Insert the power brush into the base of the conductive metal tube by clicking it into place. Then insert the conductive metal tube into the vacuum cleaner body. When successfully installed, the parts will "click" into place.

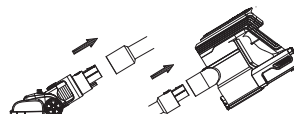

4. If using the power brush without the conductive metal tube, simply attach it to the vacuum cleaner body. When successfully installed, the parts will "click" into place.

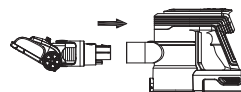

5. When attaching accessories, refer steps 1-4 above and substitute the reference to the power brush with the accessory in question. Use the upholstery nozzle to vacuum fabric furnishings such as sofas, armchairs and curtains. Use the crevice nozzle to vacuum narrow spaces such as corners and hard to reach areas.

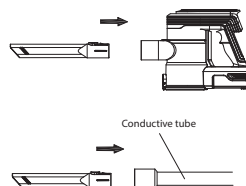

OPERATION

1. Before first use, ensure the battery is fully charged. Please refer to the “Install and Charge of Battery Pack” instructions on page 5 for charging and installation of the battery pack.
2. Once the battery is fully charged, assemble the vacuum cleaner to the desired configuration to prepare for use. Refer page 6 for configurations ie: motor head or accessory assembly.

3. Press the “ON/OFF” button on the back of the appliance to activate the vacuum cleaner. The unit will automatically default to the “ECO” vacuum mode and begin operation.



4. If additional suction power is required, press the power button on the top of the appliance activate “MAX” mode. To revert back to “ECO” mode, press the power button again. The power level “ECO” or “MAX” can be alternated between at any time by pressing the power button.

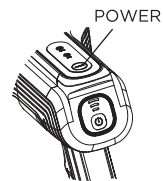

5. When vacuuming has been completed, turn the unit off again by pressing the “ON/OFF” button.



NOTE: Although suitable for light use on carpets, cordless vacuum cleaners perform best when used on hard floors.

NOTE: To ensure maximum performance is maintained, regular cleaning of the filters and power brush is required. The filters and power brush are recommended to be thoroughly cleaned at least once per month.

NOTE: Running times are up to 20 minutes on MAX mode and up to 40 minutes on ECO mode.

CLEANING & CARE

1. **⚠ WARNING:** Do not under any circumstances immerse the power cord, mains plug or vacuum cleaner body in water or any other liquid.
2. **⚠ WARNING:** Do not attempt to clean the unit whilst it is still plugged into the electrical power outlet. Always unplug the unit before cleaning.
3. Do not use harsh or abrasive cleaning agents. The outside surface may be wiped clean with a soft, damp cloth and dried thoroughly. If necessary, a mild dishwashing detergent may be applied to the cloth but not directly applied to the vacuum cleaner or accessories. Do not place any accessories or vacuum cleaner body into a dishwasher.

Emptying the dust container

1. Disconnect the conductive metal tube and or accessories from the vacuum cleaner body.
2. Over a waste bin, press the dust cover release button to open the dust cover and disperse contents into a waste bin. Wipe clean only. Do not submerge the the dust container or any other part in water or any liquids. When emptied, close the dust cover by pressing the cover back onto the dust cannister. When successfully installed, the dust cover will "click" into place.

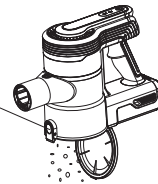

Disassembly and cleaning of the dust container and filters

1. Disconnect the tube or accessories from the vacuum cleaner body.
2. Press the dust container release button and rotate the container clockwise to release. Remove the dust container. Wipe clean only. Do not submerge the dust container in water or any liquids.
3. Once the dust container has been removed, rotate the filter assembly clockwise to release. Remove the filter assembly.
4. Once the filter assembly has been removed, remove the fine particle filter. The filter assembly and fine particle filter can be submersed and thoroughly rinsed. Do not scrub with abrasive products as this may damage the fine particle filter. Allow to dry thoroughly before reassembly.

Dust container release button.



Dust container.



Filter assembly.



Fine particle filter.



CLEANING & CARE (CONTINUED)

Cleaning power brush head and roller

After extended periods of use, the power brush head and roller will require cleaning to remove hair and other foreign objects that have become tangled or stuck, preventing the vacuum cleaner from operating effectively. Regular cleaning is recommended and described in the steps below.

1. Pull downwards on the brush roller locking clip (A) and lift the locking lever (B) in an upwards motion.

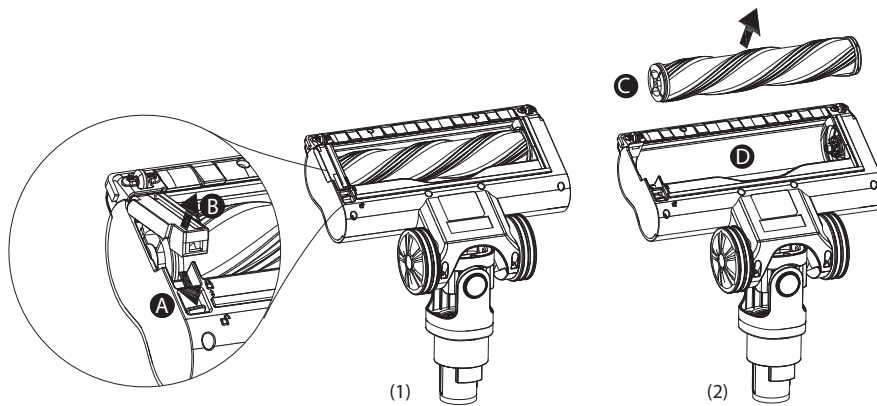

2. Lift the brush roller (C) from the power brush head housing.
3. Wipe the power brush head (D) down with a damp cloth to remove debris and dirt particles. **Do not expose or immerse the power brush head (D) in water or any other liquid as the electronic components inside will be damaged.**
4. Clean and remove any hairs and fibers from the brush roller (C) then rinse under running water. Do not use harsh cleaning agents. Allow to completely dry before reassembly.
5. To reassemble, place the brush roller (C) back into the power brush head housing (D). Pull downwards on the brush roller locking clip (A) and lower the locking lever (B). Once the locking lever (B) has been lowered, release the locking clip (A) to secure.

TROUBLESHOOTING

BEFORE CALLING FOR SERVICE

If the appliance fails to operate:

1. Check to ensure the battery is fully charged.
2. Check for a blown or tripped circuit breaker in your home. If these seem to be working correctly, test another appliance in the same outlet to ensure the outlet is working correctly.

IF NONE OF THE ABOVE SOLVES THE PROBLEM, DO NOT TRY TO ADJUST OR REPAIR THE APPLIANCE YOURSELF.

CUSTOMER SERVICE

In the event you believe your device to be defective, please return it along with your sales receipt to the place of purchase for resolution.

For any enquiries, please call our service center on: Tel: 1300 883 109

TROUBLESHOOTING

Troubleshoot your problem by using the chart below. If the unit still does not operate correctly, it may be defective.

TROUBLE	POSSIBLE CAUSE	POSSIBLE REMEDY
The motor does not operate.	No battery or no charge. Metal tube, power brush, battery pack or vacuum cleaner body not assembled correctly.	Insert battery & charge the vacuum cleaner. Check components are assembled correctly.
Suction power level is very low.	Dust bin is full. Filters dirty or blocked. Air inlet of tube or power brush is blocked.	Empty the dust bin. Clean or replace the filter. Clean dirt and debris that may be blocking airflow inside the tube and power brush.
The running time is not sufficient after charging.	The battery has not been fully charged. The battery has reached the end of its working cycle life.	Fully charge the battery as directed in the battery charging section. Replace the battery.

LIMITED WARRANTY

1. Nothing in this Warranty affects the Consumer's rights under the Australian Consumer Law. The benefits to the Consumer under this Warranty are in addition to the rights and remedies of the buyer under any Consumer Guarantees. The Australian Consumer Law requires that we confirm that:

Our goods come with guarantees that cannot be excluded under the Australian Consumer Law. You are entitled to a replacement or refund for a major failure and for compensation for any other reasonably foreseeable loss or damage. You are also entitled to have the goods repaired or replaced if the goods fail to be of acceptable quality and the failure does not amount to a major failure.

2. Subject to Clause 1, the Seller warrants that Westinghouse branded products will be free of manufacturing defects and will perform to the Seller's specifications subject to the following clauses.
3. The benefit of this Warranty extends only to the owner of the property in which the Products manufactured or supplied by the Seller are installed and used by the owner for the duration of the Warranty Period.
4. The Warranty commences on the date of the purchase of the product and continues for the benefit of the Owner for the Warranty Period. If within the Warranty Period a manufacturing defect is discovered in the Product, or the Product fails to perform to the Seller's specifications as a result of some defect in material or workmanship in the Product, then the Seller will at its own discretion:
 - a.) Repair or replace the Product at the cost of the Seller, including but not limited to labour and travel costs. Goods repaired or replaced under this Warranty will be warranted for the remaining period of the Warranty.
 - b.) Refund the purchase price paid by the consumer.
5. The Warranty does not apply to Product that :
 - a.) Has failed due to excessive wear and tear beyond what is considered to be reasonable.
 - b.) Has been misused or neglected.
 - c.) Has been damaged accidentally or by acts of God including fire and flooding.
 - d.) Has been used or operated contrary to operating or maintenance instructions.
 - e.) Has been damaged by the Consumer or a third party authorised to act for the consumer in transit from the Sellers store to the Consumer.
6. In order to make a claim under the Warranty, the Owner must, where possible return the goods to the Seller's store at the Owner's cost. Proof of purchase must be supplied in all cases.
7. The seller will examine any returned Products and if the Seller determines that there is an apparent defect through no fault of the Owner, the Seller will:
 - a.) Make note of the Owner's contact details including the Owner's telephone number which the owner can be contacted during business hours, postal address and e-mail address.

- b.) Make note of the defects reported by the Owner.
 - c.) Take back the defective goods from the owner and determine within a reasonable time through dialogue with the Seller whether the goods are defective.
 - d.) Advise the owner within a reasonable time frame whether it accepts or rejects the Product claim.
 - e.) If the Seller accepts the return of the Product, the Seller must arrange to have
 - i) The Product repaired or,
 - ii) Replace the damaged or faulty Product or,
 - iii) Refund the purchase price.
8. The Seller will not accept any returned Product which has not been returned strictly in accordance with this Warranty.
9. For the purpose of this Warranty:
- a.) Australian Consumer Law means the law as set out in Schedule 2 of the Competition and Consumer Act 2010 (Cth).
 - b.) Consumer means the Purchaser of goods from the seller.
 - c.) Consumer means a Consumer as that term is set out in section 3 of the Australian Consumer Law.
 - d.) Consumer Guarantees means the guarantees under the Australian Consumer Law.
 - e.) Implied terms means any guarantees, conditions, warranties or other terms implied by any Australian Commonwealth, State or Territory laws, (excluding the Australian Consumer Law) or the law of any other jurisdiction.
 - f.) Owner has the meaning set out in clause 3.
 - g.) Warranty means this warranty.
 - h.) Product means the Product/s bought by the Owner from the Seller that fall under this warranty.
 - i.) Warranty Period means:

i) In relation to Cast Iron Cookware:	3 Year Limited Warranty.
ii) In relation to Non-Stick Cookware:	3 Year Limited Warranty
iii) In relation to Cooking Utensils:	3 Year Limited Warranty
iv) In relation to Knives/Knife Block Sets:	3 Year Limited Warranty
v) In relation to Stainless Steel Cookware:	10 Year Limited Warranty
vi) In relation to Chopping boards:	1 Year Limited Warranty
vii) In relation to Small Appliances:	1 Year Limited Warranty



Westinghouse

INNOVATION YOU CAN BE SURE OF

www.westinghousesmallappliances.com.au

CUSTOMER SERVICE - AU: 1300 883 109
info@westinghousesmallappliances.com.au

CUSTOMER SERVICE - NZ: 0508 776 546
info@westinghousesmallappliances.co.nz

IMPORTED AND DISTRIBUTED BY RVM AUSTRALIA PTY LTD.
11 Tamara Drive, Cockburn Central, WA 6164
MADE IN CHINA

© 2021 RVM AUSTRALIA PTY LTD. ALL RIGHTS RESERVED.

®, WESTINGHOUSE, and INNOVATION YOU CAN BE SURE OF
are trademarks of Westinghouse Electric Corporation.
Used under license by RVM AUSTRALIA PTY LTD. ALL RIGHTS RESERVED.