

BATTERY METER

SMART BATTERY GAUGE



IMPORTANT SAFETY INFORMATION

Please read this instruction thoroughly before installing the product.

WARNINGS

- Risk of explosive gas. Working in the vicinity of a lead-acid battery can be dangerous
- Batteries might release explosive gases during normal operation and charging
- Before using the product, read and follow the instructions carefully. Follow all manufacturer's instructions
- Do not smoke, use matches, use a cigarette lighter, or allow a spark or flame near the battery
- Remove rings, bracelets, necklaces and watches when working with a lead-acid battery
- Before accessing the battery leads (Red for positive and Black for negative), disconnect the all devices or power sources from sockets and dc terminals provided by the product
- Do not submerge the product in water or expose to rain
- Not recommended to use the product for critical power backup application
- Designed to work with 12V lead acid battery only
- This appliance is not intended for use by young children or infirm persons without supervision. Young children should be supervised to ensure that they do not play with the appliance
- Ensure that all cable connections have the correct polarity and are protected against accidental short circuit
- Do not allow water or other liquids to enter the installation area

OVERVIEW

Projecta BM320 – A sophisticated, full colour LCD monitor that accurately displays a battery's total capacity, overall health and general status. It is Ideal for camper trailer and caravan interiors as it is housed in a modern and simple to install enclosure. The BM320 comes with all the necessary components to connect to your battery system.

It has the following features:

- 2.4" full colour LCD display
- Configurable Low battery capacity and battery health alarm
- Suitable for popular deep cycle AGM lead acid battery
- Using patented technology to monitor battery characteristics like battery state of charge and state of health

DISPLAY SCREEN INSTALLATION

Choose a flat location which is easily accessible and easy to view the display screen.

The location should be indoors away from weather.

Screw the mounting clip using supplied self-tapping screws ensuring that the arrow is pointing "UP".

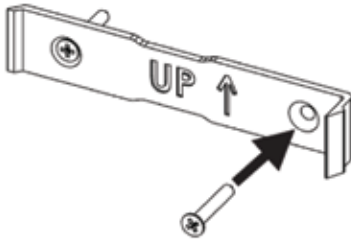

Drill a 15mm Diameter hole 20mm from the screw hole as pictured to allow the connector to pass through.

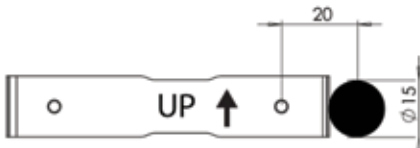

Plug in the supplied four pin connector to the receptacle at the back of the battery monitor.

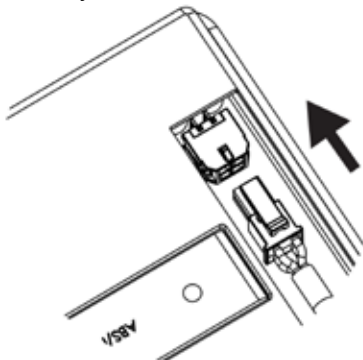

Feed the cable through the pre drilled hole and slide the left hand side of the battery monitor into the bracket tab.

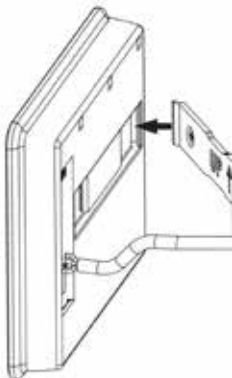

Close the battery monitor onto the clip until you hear the "click" sound. Make sure that the cable assembly has been fed into the hole correctly.

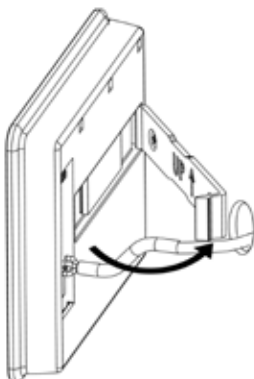

SHUNT AND WIRING INSTALLATION

IMPORTANT: to maintain accurate record of the battery capacity, all current must be passed through the shunt.

Disconnect the battery and turn off all devices before beginning the installation.

Mount the shunt in a secure location with adequate protection from damage.

The BM320 is designed for 12V applications only.

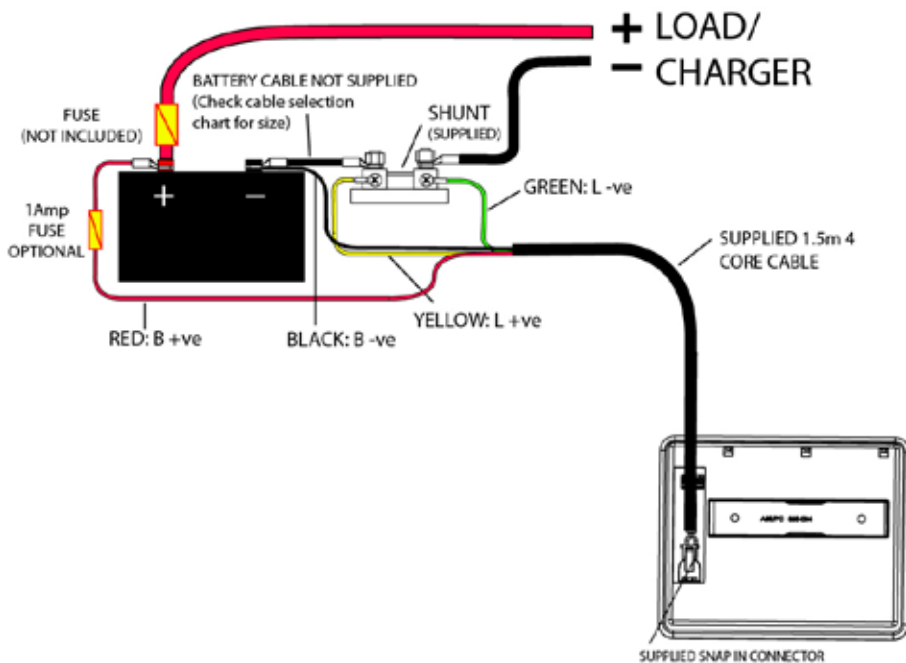

NOTE: There should only be one cable connected to the battery negative terminal. This should be to the battery side of the shunt to ensure all load is measured through the shunt. All other NEG/Earth connections should be made at a load side of the shunt.

BATTERY CABLE SELECTION CHART

Nearest B&S	Nominal Area (mm ²)	AMP Rating (40°C)	Nominal O.D. (mm)
8	7.71	66	5.5
6	13.5	92	7.2
4	20.26	120	8.3
3	26.45	150	10.2
2	32.07	167	11.3
1	39.55	187	12.1
0	49	219	12.7
00	64.15	260	14.5
000	83.19	298	16.4

ALTERNATIVE CONNECTION METHOD

NOTE: USE ONLY ONE CONNECTION METHOD.

To connect using your own wiring harness use the supplied terminal block.

The terminal block is labelled, ensure you follow the wiring diagram and follow the colour coded connection sequence.

Ensure no short circuit between the connector terminals and the wires. It is recommended that a Fuse (1A fast blow) be used in line with the B+ve line.

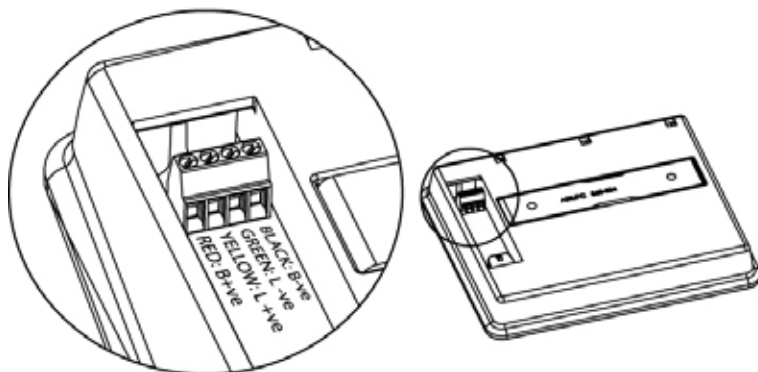

QUICK START

1. Press ENTER button to acknowledge the Welcome message on the LCD screen
2. Select the type of battery (AGM,WET,GEL,CAL)
3. Enter the battery capacity and press ENTER button to confirm
4. Enter value for the low battery capacity alarm and press ENTER button to confirm
5. Enter the value for battery health warning alarm and press ENTER button to confirm
6. For most accurate results – Charge the battery to full with any multi-stage battery charger
7. Disconnect the battery charger when the battery is full
8. Unit is ready to use

SPECIFICATIONS

Part No.	BM320
Battery Fuel Gauge	
Input consumption current (backlight off)	12V/1.5 mAdc
Input Voltage Range	6.0--17.0 Vdc
Max discharge current	320A
Display Resolution: Current Voltage	0.1 A 0.1V
Battery Capacity	0.1Ah
Type of Battery Supported	Wet/AGM/Gel/Calcium
Display Physical Characteristics	
Weight	0.12 kg
External Dimension	118mm (L) x 96mm (W) x 18mm(H)
Operating Temperature	0 to 50°C
Compliance	
EMC	Certified to meet AS/NZS 61000.6.3

BATTERY GUAGE USER INTERFACE

Main Menu

To enter into the main menu press the menu button \equiv on the display screen. To move through the menu press the up and down buttons. Press the Enter \rightarrow button to change the settings.

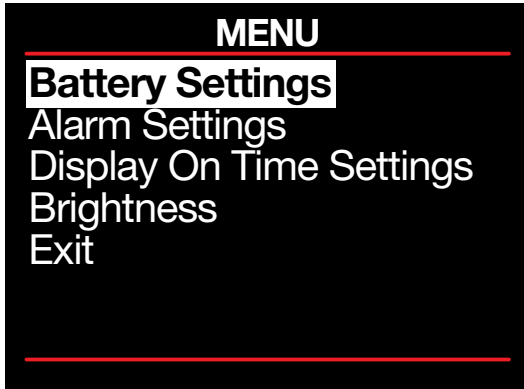

Function	Description
Battery Settings	Set Battery Capacity
Alarm Settings	Set Low Battery Capacity and Battery Health Alarms
Display On Time Settings	Set the LCD Display On Time (10 mins as default on time)
Brightness	Set the brightness of the LCD Display (50% as default value)
Exit	Exit Menu Screen and return to Default Screen

Default Screen

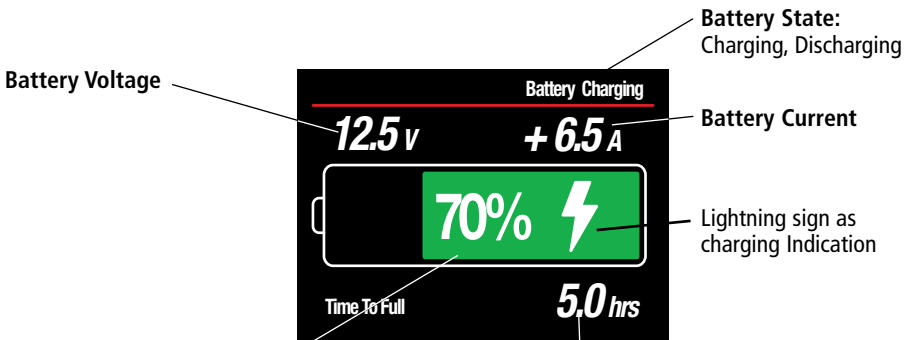

Battery State of Charge (SOC) in %

Battery Symbol Colour:

Green – 50% < SOC < 100%

Orange – 20% < SOC < 50%

Red – SOC < 20%

Time to Full when the battery is charging, Time to Empty when the battery is discharging, or Display "System Idle" when no current passes through the battery

ADVANCED SCREEN

Battery Current
 "+" for Charging and
 "-" for Discharging

Battery Voltage

Battery Health has 4 levels: Ideal, Good, Fair and Poor

Battery Capacity

Battery State:
 Charging, Discharging

Battery State of Charge in %

Lightning sign as charging Indication

Battery Symbol Colour:
 Green – 50% < SOC < 100%
 Orange – 20% < SOC < 50%
 Red – SOC < 20%

Time to Full when the battery is charging, Time to Empty when the battery is discharging, or Display "System Idle" when no current passes through the battery

Battery Charging	
12.5v	+ 6.5A
Battery Health	GOOD
Power Remaining	100.0Ah
Time To Full	5.5hrs
	70% [Battery Icon with Lightning Sign]

BATTERY SETTINGS

Use Up and Down buttons to choose your battery type which is marked on the battery case. Press ENTER button to apply the changes. The default type is AGM.



Use Up and Down buttons to change the value of battery capacity which is marked on the battery case. Press ENTER button to apply the changes. The default value is 100Ah.

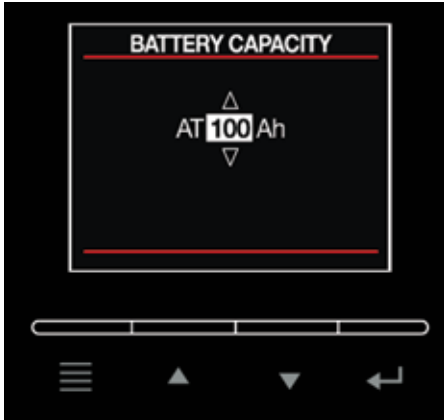

ALARM SETTINGS

LOW BATTERY CAPACITY

Use Up and Down buttons to change the value of low battery capacity alarm. Reduce the value to 0 to disable the alarm. Press ENTER button to apply the changes. The default value is 10Ah.

When the battery depletes its capacity to the set level, an audio alarm is activated. The audio alarm can be muted by pressing any button.

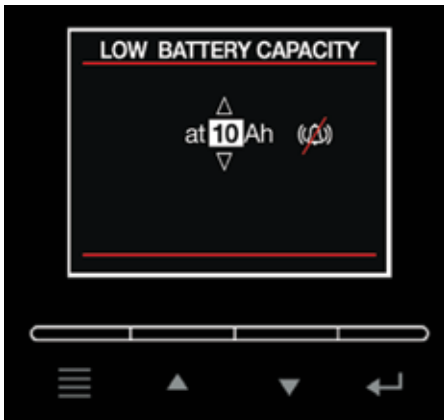

BATTERY STATE OF HEALTH

Use Up and Down buttons to change the value of battery state of health alarm. Reduce the value to 0 to disable the alarm. Press ENTER button to apply the changes. The default value is 30%.



The battery state of health diminishes to the set level, an audio alarm is activated. The audio alarm can be muted by pressing any buttons.

DISPLAY ON TIME SETTING

Use Up and Down buttons to change the LCD display on time. Press ENTER button to apply the changes. The default value is 10 mins.



BRIGHTNESS

Use Up and Down buttons to change the brightness of LCD display. Press ENTER button to apply the changes. The default value is 50%.

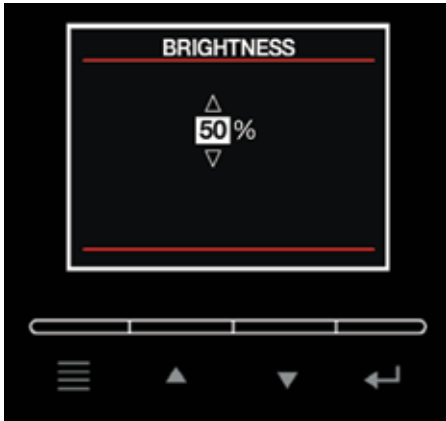

BATTERY HEALTH

It is an indicator to show if the battery requires rejuvenation or replacement.

Indication	Description
Ideal or Good	No action is needed
Fair	Try to rejuvenate the battery
Poor	Try to rejuvenate the battery as soon as possible. If the battery health indicator is still Poor after rejuvenation, the battery is close to its end of life, replace the battery as soon as possible

FREQUENTLY ASKED QUESTIONS

Q.What is state of charge (SOC)?

A. It is the remaining battery capacity expressed as a percentage of full charge capacity.

Q.What is State of Health (SOH) or Battery Health?

A. It is expressed as a percentage of the ratio of predicted full charge capacity over the design capacity. The BM320 uses 4 levels to represent the battery health: Ideal, Good, Fair and Poor. Please look at the battery health section for more detail.

Q.What is the low battery capacity alarm for?

A. The unit uses audio alarm to remind the user that the battery capacity is reduced to the set level.

Q.What is the battery health alarm for?

A. The unit uses audio alarm to remind the user that the battery state of health is reduced to the set level.

NOTES

NOTES

WARRANTY STATEMENT

APPLICABLE ONLY TO PRODUCT SOLD IN AUSTRALIA

Brown & Watson International Pty Ltd of 1500 Ferntree Gully Road, Knoxfield, Vic., telephone (03) 9730 6000, fax (03) 9730 6050, warrants that all products described in its current catalogue (save and except for all bulbs and lenses whether made of glass or some other substance) will under normal use and service be free of failures in material and workmanship for a period of one (1) year (unless this period has been extended as indicated elsewhere) from the date of the original purchase by the consumer as marked on the invoice. This warranty does not cover ordinary wear and tear, abuse, alteration of products or damage caused by the consumer.

To make a warranty claim the consumer must deliver the product at their cost to the original place of purchase or to any other place which may be nominated by either BWI or the retailer from where the product was bought in order that a warranty assessment may be performed. The consumer must also deliver the original invoice evidencing the date and place of purchase together with an explanation in writing as to the nature of the claim.

In the event that the claim is determined to be for a minor failure of the product then BWI reserves the right to repair or replace it at its discretion. In the event that a major failure is determined the consumer will be entitled to a replacement or a refund as well as compensation for any other reasonably foreseeable loss or damage.

This warranty is in addition to any other rights or remedies that the consumer may have under State or Federal legislation.

IMPORTANT NOTE

Our goods come with guarantees that cannot be excluded under the Australian Consumer Law. You are entitled to a replacement or refund for a major failure and compensation for any other reasonably foreseeable loss or damage. You are also entitled to have the goods repaired or replaced if the goods fail to be of acceptable quality and the failure does not amount to a major failure.

Distributed by

AUSTRALIA

Brown & Watson International Pty Ltd

Knoxfield, Victoria 3180

Telephone (03) 9730 6000

Facsimile (03) 9730 6050

National Toll Free 1800 113 443

NEW ZEALAND

Narva New Zealand Ltd

22–24 Olive Road

PO Box 12556 Penrose

Auckland, New Zealand

Telephone (09) 525 4575

Facsimile (09) 579 1192