

Dishwasher

Instruction Manual

**MDWMINIW, MDWMINIBL
MDWMINIS, MDWMINIC**



Please read this Manual carefully before using your dishwasher and keep it for future reference.

QUICK USER GUIDE

Please read the main content in the instruction manual for detailed operating method.

Connected to power supplies

The power supply is 220-240VAC 50 Hz
the specification of the socket is 10 A 250 VAC

The connection of the drain pipe: Put end of the drain hose into a sink or bucket.

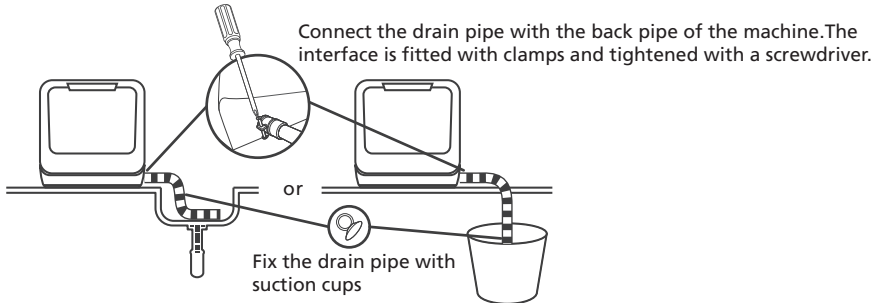

Add water into the dishwasher's tank

Note: Before adding water, you need to press power button to turn on the dishwasher

There are two ways to add water into the tank:

- 1 Connect inlet hose to the tap or,
- 2 Open the cap and add water into the dishwasher's tank manually

There are two ways of checking the tank is full of water

1. Before starting:

When the water tank is full, the machine will beep for 3 seconds.

2. After starting:

If water is not enough,  light is on;

When the water tank is full the machine will beep for 3 seconds.

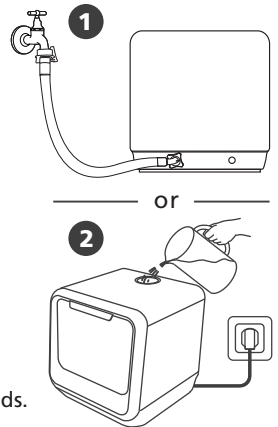

Remove the larger residue

Scrape off excess food before placing the dishes in the dishwasher.

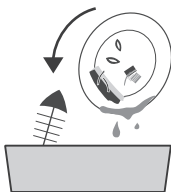

Open the door, placing the dishes and adding detergent

Place large items on the sides and small items in the middle for optimal cleaning performance. All cutlery should be placed in cutlery basket.

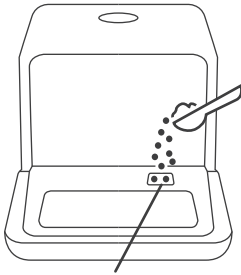
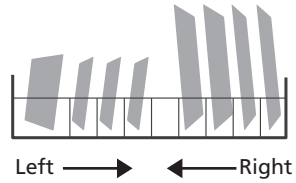
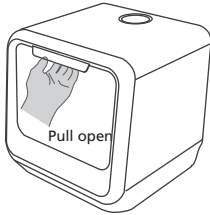

The place to add the detergent

NB: Do not add detergent when selecting Fruit Program!

Close the door, select the program and start the dishwasher

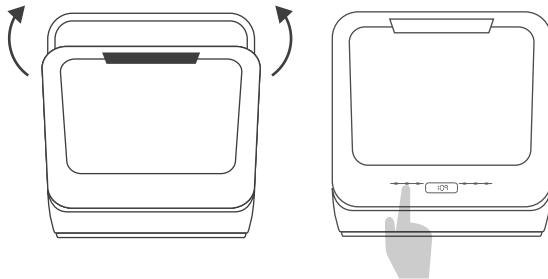

CONTENTS

Please carefully read this manual before using the dishwasher, it will help you use and maintain the dishwasher properly .

01	5	IMPORTANT SAFETY INSTRUCTIONS
02	10	GETTING TO KNOW YOUR APPLIANCE
	10	Dishwasher features
	11	Control panel
03	12	USING YOUR DISHWASHER
	12	Loading the dishwasher baskets
	15	Filling the dispenser
04	17	PROGRAMMING THE DISHWASHER
	17	Wash cycle table
	18	Turning on the appliance
	18	Change the programme
	19	Forget to add a dish?
	20	At the end of the wash cycle
	20	Forced drainage operation
05	21	MAINTENANCE AND CLEANING
	21	Filter system
	22	Caring for the dishwasher
	24	How to keep your dishwasher in shape
06	25	INSTALLATION INSTRUCTION
	25	Installation preparation
	26	Power connection
	26	Water connection
	27	Connection of drain hoses
07	28	TROUBLESHOOTING TIPS
	28	Before calling for service
	31	Error codes
	32	Technical information

IMPORTANT SAFETY INSTRUCTIONS

⚠ WARNING

When using your dishwasher, follow the precautions listed below:

- This appliance is intended to be used in households and similar applications such as:
 - staff kitchen areas in shops, offices and other working environments;
 - by clients in hotels, motels and other residential type environments;
 - bed and breakfast type environments.
- Caravans and RV Recreational vehicles and Motor Homes.
- This appliance can be used by children aged from 8 years and above and persons with reduced physical, sensory or mental capabilities or lack of experience and knowledge if they have been given supervision or instruction concerning use of the appliance in a safe way and understand the hazards involved. Children shall not play with the appliance. Cleaning and user maintenance shall not be made by children without supervision.(For AS/NZS 2007.1)
- This appliance is not intended for use by persons (including children) with reduced physical, sensory or mental capabilities, or lack of

experience and knowledge, unless they have been given supervision or instruction concerning use of the appliance by a person responsible for their safety.

(For IEC60335-1)

- This appliance is for indoor use only, household and mobile home use only.
- To protect against the risk of electrical shock, do not immerse the unit, cord or plug in water or other liquid.
- Please unplug before cleaning and maintaining the appliance.
Use a soft cloth moisten with mild soap, and then use a dry cloth to wipe it again.

Earthing instructions

- This appliance must be earthed. In the event of a malfunction or breakdown, earthing will reduce the risk of an electric shock by providing a path of least resistance of electric current. This appliance is equipped with a cord having an equipment-earthing conductor and a earthing plug.
- The plug must be plugged into an appropriate outlet that is installed and earthed in accordance with all local codes and ordinances.

- Do not modify the plug provided with the appliance, if it does not fit the outlet. Have a proper outlet installed by a qualified electrician.
- Improper connection of the equipment-earthing conductor can result in the risk of an electric shock. Check with a qualified electrician or service representative if you are in doubt whether the appliance is properly earthed.

General use

- Do not abuse, sit on, or stand on the door or dish rack of the dishwasher.
- Do not operate your dishwasher unless all enclosure panels are properly in place.
- Open the door very carefully if the dishwasher is running, there is a risk of water splashing out.
- Do not place any heavy objects on or stand on the door when it is open. The appliance could tip forward.
- When loading items to be washed:
 - 1) Locate sharp items so that they are not likely to damage the door seal;
 - 2) **Warning:** Knives and other utensils with sharp points must be loaded in the basket with their points down or placed in a horizontal position.
- Check that the detergent powder is empty after completion of the wash cycle.

- Do not wash plastic items unless they are marked dishwasher safe or the equivalent. For plastic items without mark, check the manufacturer's recommendations.
- Use only detergent additives designed for an automatic dishwasher.
- Never use soap, laundry detergent, or hand washing detergent in your dishwasher.
- Children should be supervised to ensure that they do not play with the appliance.
- The door should not be left open.
If the supply cord is damaged, it must be replaced by
- the manufacturer or its service agent or a similarly qualified person in order to avoid a hazard.
During installation, the power supply must not be
- excessively or dangerously bent or flattened.
Do not tamper with controls.
- The appliance is to be connected to the water mains
- using new hose sets and that old hose-sets should not be reused.
The maximum number of place settings to be
- washed is 3.
The maximum permissible inlet water pressure is 1MPa.
- The minimum permissible inlet water pressure is 0.04MPa.

Disposal

- For disposal of package and the appliance, please go to a recycling centre. Therefore cut off the power cord and close the door.



- Cardboard packaging is manufactured from recycled paper and should be disposed in the waste paper collection for recycling.
- By ensuring this product is disposed of correctly, you will help prevent potential negative consequences for the environment and human health, which could otherwise be caused by inappropriate waste handling of this product.
- For more detailed information about recycling of this product, please contact your local city office and your household waste disposal service.
- **DISPOSAL:** Do not dispose this product as unsorted municipal waste. Collection of such waste separately for special treatment is necessary.

GETTING TO KNOW YOUR APPLIANCE

IMPORTANT:



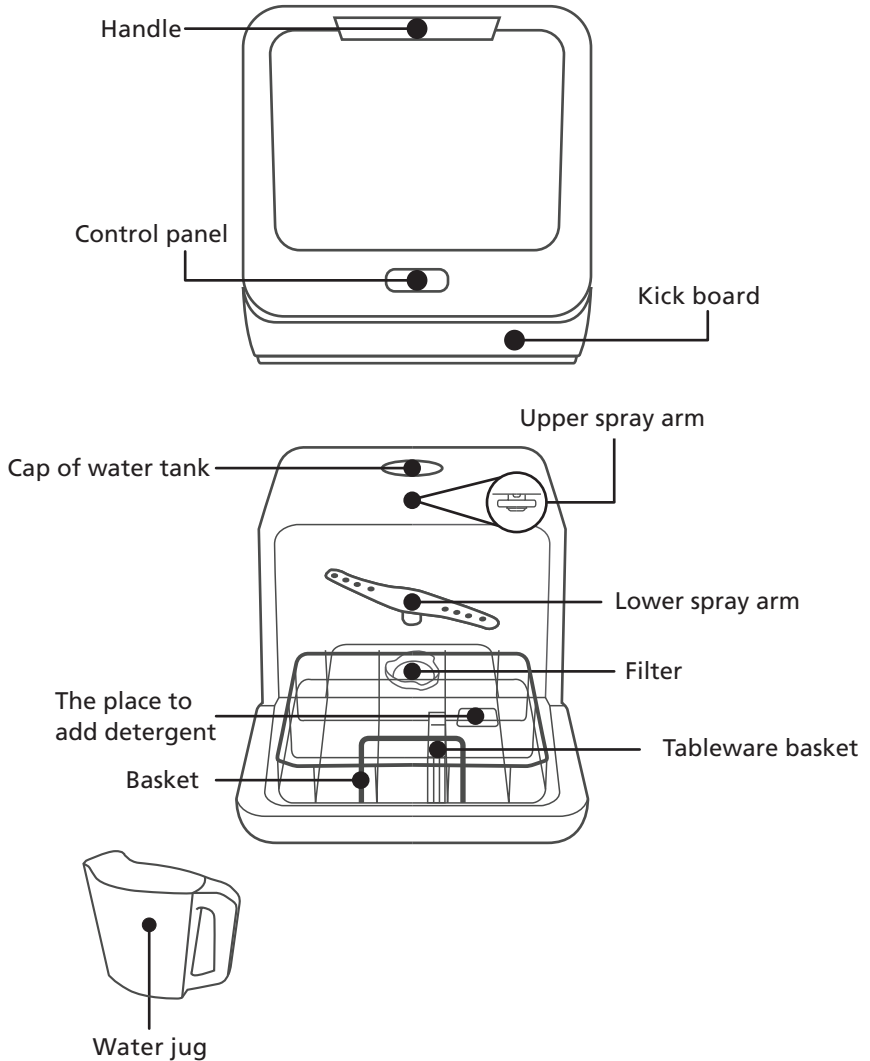

Before using this dishwasher for the first time and to get the best performance, read these instructions.

Dishwasher features

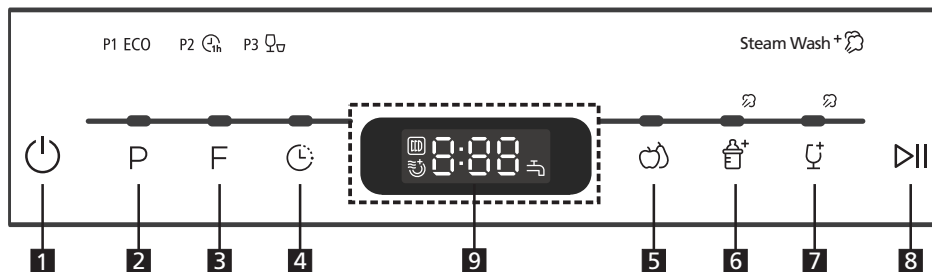

Control panel



1 Power	To turn on and off.
2 Program	Program Button: Press the button to select wash cycles P1(ECO ECO) -P2 (1 hour ) -P3 (rapid ). ECO(Steam Adding)
3 Function	 Storage Get rid of the smell, damp and mildew proofing.  Extra dry To select the extra dry function.
4 Delay	To show the delay time 00~24h.
5 Fruit wash	Hot water: Suitable for washing fruit surfaces of a certain size, such as apple, grape, jujube. Cold water: Suitable for fruits with a weak surface, such as strawberries.
6 Baby care	Suitable for washing baby bottles. (Steam wash function)
7 Glass wash	For lightly soiled loads, such as glasses, crystal and fine china. (Steam wash function)
8 Start/Pause	Press this button to start or pause the dishwasher, the process pilot lamp will be blinking when starting.
9 Display	Displays the time, functions,etc.

USING YOUR DISHWASHER

• **Loading the dishwasher baskets**

Recommendation

- Consider buying utensils which are identified as dishwasher-proof.
- Use a mild detergent that is described as 'kind to dishes'. If necessary, seek further information from detergent manufacturers.
- For particular items, select a program with as low temperature as possible.
- To prevent damage, do not take glass and cutlery out of the dishwasher immediately after the program has ended.

Suitability of use in the dishwasher

Not suitable for use:

- Cutlery with wooden, horn, china or mother-of-pearl handles
- Plastic items that are not heat resistant
- Older cutlery with glued parts that are not temperature resistant
- Bonded cutlery items or dishes
- Pewter or copper items
- Crystal glass
- Wooden items
- Items made from synthetic fibres

Limited suitability:

- Some glasses can become dull after a large number of washes.
- Silver and aluminium have a tendency to discolour during washing.
- Glazed patterns may fade if washed frequently.

Attention before or after loading the dishwasher baskets

(For the best performance of the dishwasher, follow these loading guidelines. Features and appearance of baskets and cutlery baskets may vary from your model.)
Scrape off any large food particles. Soften remnants of burnt food in pans. It is not necessary to rinse the dishes under running water. Place objects in the dishwasher in the following way:

- Items such as cups, glasses, pots/pans, etc. facing downwards.
- Curved items, or those with recesses, should be loaded at an angle so that water can run off.
- All utensils are stacked securely and can not tip over.

- All utensils are placed to allow the spray arms to rotated freely during washing.

⚠ NOTE

Very small items should not be washed in the dishwasher as they could easily fall out of the basket.

- Load cups, glasses, pans etc. with the opening facing downwards so that water cannot collect in the container or a deep base.
- Dishes and items of cutlery must not lie inside one another, or cover each other.
- To avoid damage to glasses, they must not be touched by spray arm.
- Long bladed knives stored in an upright position are a potential hazard!
- Long and/or sharp items of cutlery such as carving knives must be positioned horizontally in the basket.
- Please do not overload your dishwasher. This is important for good results and for reasonable energy consumption.

Loading the basket

Position the dishes and cookware so that they will not come into contact with the spray arm.

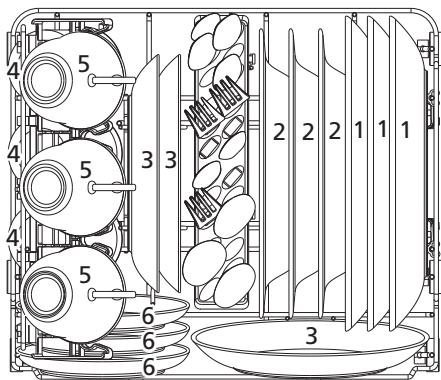

Number	Item
1	Dinner Plate
2	Soup Plate
3	Dessert Dish
4	Glass
5	Cup
6	Saucer

Loading the cutlery basket



Number	Item
1	Knife
2	Soup spoon
3	Fork
4	Dessert spoon
5	Teaspoon

For personal safety and a top quality clean, make sure to place the cutlery in the basket as follows:

- They do not nest together.
- Place silverware with handles-down.
- But place knives and other potentially dangerous utensils handles-up.

Folding back the rack shelves

The spikes are used for holding plates and a platter. They can be lowered to make more room for large items.

raise upwards

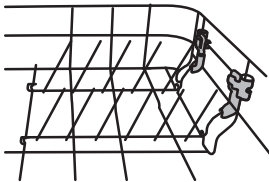

fold backwards

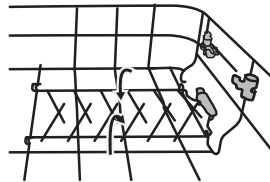

• Filling the dispenser

The rinse aid is released during the final rinse to prevent water from forming droplets on your dishes and utensils, which can leave spots and streaks.

⚠ WARNING

- **Only use detergent specifically for dishwashers.**
Never use any other rinse aid and detergents. This will damage the appliance.
-  **Dishwasher detergent is corrosive! Keep dishwasher detergent out of the reach of children.**

Concentrated Detergent

Based on their chemical composition, detergents can be split in two basic types:

- Conventional, alkaline detergents with caustic components.
- Low alkaline concentrated detergents with natural enzymes.

The use of Normal washing program in combination with concentrated detergent reduces pollution and is good for your dishes.

Detergent Tablets

Detergent tablets of different brands dissolve at different speeds. For this reason some detergent tablets cannot dissolve and develop their full cleaning power during short Programs. Therefore please use long programs when using detergent tablets, to ensure the complete removal of detergent residuals.

Detergent

The detergent must be refilled before the start of each wash cycle following the instructions provided in the Wash Cycle Table. Your dishwasher uses less detergent than conventional dishwasher. Generally, only one tablespoon of detergent is needed for a normal wash load. More heavily soiled items need more detergent. Always add the detergent just before starting the dishwasher, otherwise it could get damp and will not dissolve properly.

Adding detergent

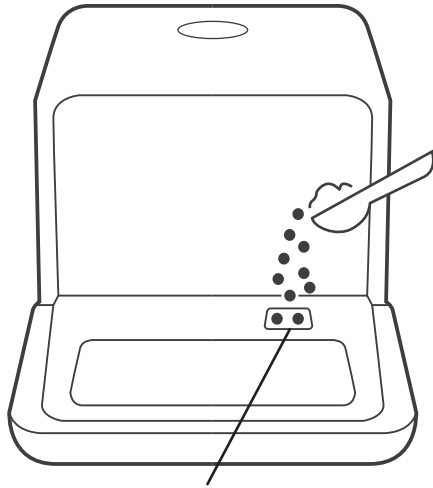







Add the detergent here.
Do not add detergent for the fruit wash program!!!

PROGRAMMING THE DISHWASHER

Wash cycle table

The table below shows which programmes are best for the levels of food residue on them and how much detergent is needed. It also show various information about the programs.

Program	Cycle Selection Information	Description Of Cycle	Detergent	Time (min)	Energy (Kwh)	Water (L)
ECO <small>(*AS/NZS 2007.1)</small>	This is standard program, it is suitable to clean normally soiled tableware and it is the most efficient program in terms of its combined energy and water consumption.	Wash (47 °C) Rinse Rinse (64 °C) Drying	7 g	175	0.36	4,9
 1 Hour	For lightly soiled loads that do not need excellent drying efficiency.	Wash(50 °C) Rinse Rinse(65 °C) Drying	6 g	60	0.4	5
 Rapid	A shorter wash for lightly soiled loads and quick wash.	Wash (50 °C) Rinse Rinse (60 °C)	6 g	29	0.35	5
 Fruit wash (Hot)	Suitable for washing fruit surfaces of a certain size, such as apple, grape, Not suitable for fruits with a weak surface	Wash (36 °C) Rinse	A little soda powder	12	0.15	5
 Fruit wash (Cold)	suitable for fruits with a soft surface, such as strawberries	Rinse	/	6	0.01	5
 Baby care	Suitable for washing baby bottles	Wash(69 °C) Rinse Rinse(70 °C) Drying	6 g	120	0.5	5
 Glass	For lightly soiled loads, such as glasses, crystal and fine china	Wash(50 °C) Rinse Rinse(65 °C) Drying	6 g	90	0.4	5

⚠ NOTE

AS/NZS 2007.1 : This program is the test cycle. The information for comparability test in accordance with AS/NZS 2007.1, are as follows:

The power consumption of off-mode is 0.57W,
left-on mode is 0.74W

• **Turning on the appliance**

Starting a wash cycle...

1. Draw out the basket (see the section entitled "Loading the Dishwasher").
2. Pour in the detergent (see the section "Fill the detergent").
3. Insert the plug into the socket. The power supply is 220-240VAC 50 HZ, the specification of the socket is 10 A 250 VAC.
4. Press the power button to turn on the appliance,
5. Connect the inlet hose to the tap, make sure that the water supply is turned on to full pressure, or add water tank manually.
6. Select a suitable program according to the **Wash cycle table**,
7. When a program is selected, the response light will light. Then press the Start/ Pause button, the dishwasher begins to start.

⚠ NOTE

When you press the Start/Reset button to pause during washing, the dishwasher will beep every minute unless you press the Start/Reset button to start.

• **Change the program**

Premise: You can modify the washing program, If the dishwasher has been on for a short time. Otherwise, the detergent may have already been released, and the appliance may have already drained the wash water in this case, the cycle must be restarted.

Press Start/Pause Button to pause the machine when the door is closed , Press Program Button more than three seconds the machine will be in stand by state, then you can change the program to the desired cycle setting (see the section entitled "Starting a wash program").

The Display window shows the stage of the dishwasher:

- a) Display window shows "-:--" -----> stand by;
- b) Display window shows "H:MM" and not blinking -----> pause;
- c) Display window shows "H:MM" and blinking -----> run;
- d) Display window shows "END" -----> end.

⚠ NOTE

If you open the door during washing, the machine will pause. When you press the Start/Pause Button, the machine will keep on working after 10 seconds.

If your model has power memory function, the machine will continue to finish the selected program after power restoration.

• Forget to add a dish?

A forgotten dish can be added any time before the detergent dispenser opens. If this is the case, follow the instructions below:

1. Press the Start/Pause button
2. Open the door a little to stop the washing.
3. After the spray arm stops working, you can open the door completely.
4. Add forgotten dishes.
5. Close the door.
6. Press the Start/Pause button, the dishwasher will run .

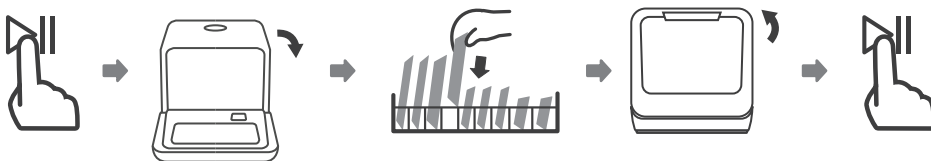

• **At the end of the Wash Cycle**

When the program cycle has finished, the buzzer of dishwasher will sound 8 seconds, then stop. Turn off the appliance using the ON/OFF button, shut off the water supply and open the door of the dishwasher.

- **Switch Off the Dishwasher**

1. Switch off the dishwasher by pressing the ON/OFF button.
2. Turn off the water tap!

- **Open the door carefully**

Hot dishes are sensitive to knocks. The dishes should be allowed to cool down around 15 minutes before removing from the appliance.

Open the dishwasher's door, leave it ajar and wait a few minutes before removing the dishes. In this way they will be cooler and the drying will be improved.

- **Unloading the dishwasher**

It is normal that the dishwasher is wet inside.

 **WARNING**

It is dangerous to open the door when washing, because the hot water may scald you.

• **Forced drainage operation**

In standby mode, you can press and hold "Baby care" button + "Glass wash" button for 3 seconds simultaneously to drain the water tank.

MAINTENANCE AND CLEANING

Filter system

⚠ WARNING

- **Never use the dishwasher without filters!**
- **Make sure the filter is properly assembled.**

The performance may be affected and dishes and utensils could become damaged.

The filter efficiently removes food particles from the wash water, allowing it to be recycled during the cycle.

For best performance and results, the filter assembly must be cleaned regularly. For this reason, it is a good idea to move the larger food particles trapping in the filter after each wash cycle by rinsing the filter and cup under running water. To remove the filter assembly, pull the cup handle in the upward direction.

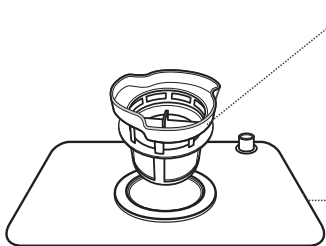

• **B. Fine filter**

This filter holds soil and food residues in the sump area and prevents it from being deposited on the dishes during wash cycle.

• **A. Main filter**

Food and soil particles trapped in this filter are pulverized by a special jet on the lower spray arm and washed down to drain.

Step 1: Contrarotate the filter assembly, then lift it all up.



Step 2: Lift fine filter up from main filter.

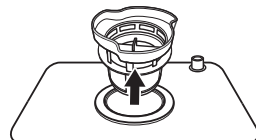

⚠ NOTE

Complete step 1 and step 2 to remove the filter system. Re-install the filter system in reverse sequence.

The entire filter assembly should be cleaned once a week.

- Inspect the filters for blocking after every time the dishwasher has been used.
- By unscrewing the coarse filter, you can remove the filter system. Remove any food remnants and clean the filters under running water.

⚠ WARNING

When cleaning the filters, don't damage them. Otherwise, the filters could be contorted and the performance of dishwasher could be decreased.

• **Caring for the Dishwasher**

The control panel can be cleaned by using a lightly dampened cloth. After cleaning, make sure to dry it thoroughly. For the exterior use a good appliance polish wax. Never use sharp objects, scouring pads or harsh cleaners on any part of the dishwasher.

Cleaning The Door

To clean the edge around the door, you should use only a soft warm, damp cloth. To avoid penetration of water into the door lock and electrical components, do not use a spray cleaner of any kind.

⚠ WARNING

- Never use a spray cleaner to clean the door panel as it may damage the door lock and electrical components.
- Abrasive agents or some paper towel should not be used because of the risk of scratching or leaving spots on the stainless steel surface.

Protect against cold climates

please take frost protection measures on the dishwasher in winter. Each time after washing cycles, please operate as follows.

- 1.** Turn off electrical power to the dishwasher.
- 2.** Turn off the water supply and disconnect the water inlet pipe from the water valve.
- 3.** Drain water from the inlet pipe and water valve (Use a pan to catch the water).
- 4.** Reconnect the water inlet pipe to the water valve.
- 5.** Remove the filter at the bottom of the tub and use a sponge to soak up water in the sump.

Cleaning the spray arms

The spray arms can be easily removed for periodic cleaning of the nozzles to prevent possible clogging. Wash them under running water and carefully replace them in their seats, checking that their rotary movement is in no way impeded.

Grasp the middle of the spray arm, pull it upwards to remove it. Wash the arms under running water and replace it carefully to its seat. After reassembly, check that the spray arms rotate freely. Otherwise, check that they have been installed correctly.

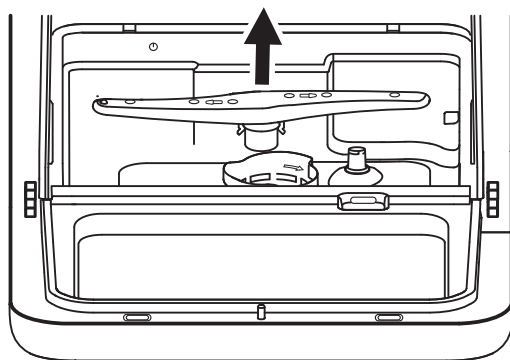

• **How to keep your dishwasher in shape**

After every wash

After every wash, turn off the water supply to the appliance and leave the door slightly open so that moisture and odours are not trapped inside.

Remove the plug

Before cleaning or performing maintenance, always remove the plug from the socket.

No solvents or abrasive cleaning

To clean the exterior and rubber parts of the dishwasher, do not use solvents or abrasive cleaning products. Only use a cloth with warm soapy water.

To remove spots or stains from the surface of the interior, use a cloth dampened with water and a little vinegar, or a cleaning product made specifically for dishwashers.

When not in use for a longtime

It is recommend that you run a wash cycle with the dishwasher empty and then remove the plug from the socket, turn off the water supply and leave the door of the appliance slightly open. This will help the door seals to last longer and prevent odours from forming within the appliance.

Moving the appliance

If the appliance must be moved, try to keep it in the vertical position. If absolutely necessary, it can be positioned on its back.

INSTALLATION

⚠ WARNING



Electrical Shock Hazard

Disconnect electrical power before installing dishwasher.

Failure to do so could result in death or electrical shock.

⚠ Attention

The installation of the pipes and electrical equipments should be done by professionals.

• Installation preparation

The installation position of dishwasher should be near the existing water inlet tap and drain outlet and power socket.

One side of the cabinet sink should be chosen to facilitate the connection of drain hoses of the dishwasher.

• Positioning the Appliance

Position the appliance in the desired location. The back should rest against the wall behind it, and the sides, along the adjacent cabinets or wall. The dishwasher is equipped with water supply and drain hoses that can be positioned to the right or the left to facilitate proper installation.

• About Power Connection

⚠ WARNING

For personal safety:

- Do not use an extension cord or an adapter plug with this appliance.
- Do not, under any circumstances, cut or remove the earthing connection from the power cord.

Electrical Requirements

Please look at the rating label to know the rating voltage and connect the dishwasher to the appropriate power supply. Use the required fuse 10 amp, time delay fuse or circuit breaker recommended and provide separate circuit serving only this appliance.

Electrical Connection

Ensure the voltage and frequency of the power corresponds to those on the rating plate. Only insert the plug into an electrical socket which is earthed properly. If the electrical socket to which the appliance must be connected is not appropriate for the plug, rather than using adaptors or the like as they could cause overheating and burns.

⚠ Ensure that proper earthing exists before use

Water Connection

Connect the cold water supply hose to a threaded 3/4 connector and make sure that it is fastened tightly in place. If the water pipes are new or have not been used for an extended period of time, let the water run to make sure that the water is clear and free of impurities. If this precaution is not taken, there is a risk that the water inlet can get blocked and damage the appliance.

Please Note: If the supplied hose does not fit your tap, please contact your local plumbing supply center where adapters are available for purchase.

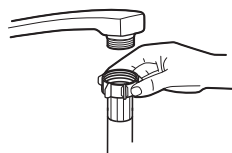

• Connection of drain hoses

Fix the drain pipe with the back pipe of the machine. The interface is fitted with clamps and tightened with a screwdriver.

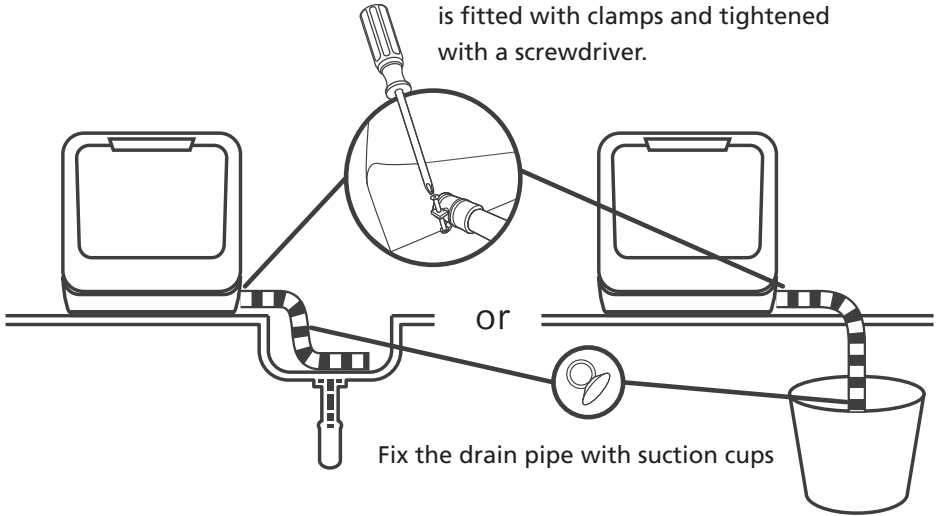

Fix the drain pipe with suction cups

The connection of the drain pipe: Put end of the drain into a sink or bucket.

How to Drain Excess Water From Hoses

If the sink is more than 1000 mm higher than the floor, the excess water in hoses cannot be drained directly into the sink. It will be necessary to drain excess water from hoses into a bowl or suitable container that is held outside and lower than the sink.

Water Outlet

Connect the water drain hose. The drain hose must be correctly fitted to avoid water leaks. Ensure that the water drain hose is not kinked or squashed.

Extension Hose

If you need a drain hose extension, make sure to use a similar drain hose. It must be no longer than 4 metres, otherwise the cleaning effect of the dishwasher could be reduced.

TROUBLESHOOTING TIPS

• Before calling for service

Reviewing the charts on the following pages may save you from calling for service.

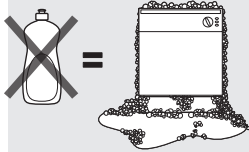
Problem	Possible Causes	What To Do
Dishwasher doesn't start	Fuse blown, or the circuit break tripped.	Replace fuse or reset circuit breaker. Remove any other appliances sharing the same circuit with the dishwasher.
	Power supply is not turned on.	Make sure the dishwasher is turned on and the door is closed securely. Make sure the power cord is properly plugged into the wall socket.
	Error code:E1; Water pressure is low	Check that the water supply is connected properly and the water is turned on.
	Door of dishwasher not properly closed.	Make sure to close the door properly and latch it.
Water not pumped from dishwasher	Twisted or trapped drain hose.	Check the drain hose.
	Filter clogged.	Check coarse the filter.
	Kitchen sink clogged.	Check the kitchen sink to make sure it is draining well. If it is blocked, you may need a plumber rather than a serviceman for dishwashers.
Suds in the tub	Wrong detergent. 	Use only the dedicated dishwasher detergent to avoid suds. If suds exist in the washer. Open the door for 20-30 minutes to allow the foam to evaporate. If the foam still exists in the liner. Add 1.5L of water to the liner, close the dishwasher door and run a forced drain to drain it with the water. Repeat above operation until the foam is cleared.

Problem	Possible Causes	What To Do
	Spilled rinse-aid.	Always wipe up rinse-aid spills immediately.
Stained tub interior	Detergent with colourant may have been used.	Make sure that the detergent has no colourant.
White film on inside surface	Hard water minerals.	To clean the interior, use a damp sponge with dishwasher detergent and wear rubber gloves. Never use any other cleaner than dishwasher detergent otherwise, it may cause foaming or suds.
There are rust stains on cutlery	The affected items are not corrosion resistant.	Avoid washing items that are not corrosion resistant in the dishwasher.
	A program was not run after dishwasher salt was added. Traces of salt have gotten into the wash cycle.	Always run a wash program without any crockery after adding salt. Do not select the Turbo function (if present).
	The lid of the softer is loose.	Check the softener lid is secure.
Knocking noise in the dishwasher	A spray arm is knocking against an item in a basket	Interrupt the programme and rearrange the items which are obstructing the spray arm.
Rattling noise in the dishwasher	Items of crockery are loose in the dishwasher.	Interrupt the programme and rearrange the items of crockery.
Knocking noise in the water pipes	This may be caused by on-site installation or the cross-section of the piping.	This has no influence on the dishwasher function. If in doubt, contact a qualified plumber.
The dishes are not clean	The dishes were not loaded correctly.	See notes in "Loading & unloading your dishwasher".
	The programme was not powerful enough.	Select a more intensive programme.

Problem	Possible Causes	What To Do
The dishes are not clean.	Not enough detergent was dispensed.	Use more detergent, or change your detergent.
	Items are blocking the movement of the spray arms.	Rearrange the items so that the spray can rotate freely.
	The filter combination is not clean or is not correctly fitted in the base of washcabinet. This may cause the spray arm jets to get blocked.	Clean and/or fit the filter correctly. Clean the spray arm jets.
Cloudiness on glassware.	Combination of soft water and too much detergent.	Use less detergent if you have soft water and select a shorter cycle to wash the glassware and to get them clean.
White spots appear on dishes and glasses.	Hard water area can cause limescale deposits.	Add more detergent.
Black or grey marks on dishes	Aluminium utensils have rubbed against dishes	Use a mild abrasive cleaner to eliminate those marks.
Detergent left in dispenser	Dishes block detergent dispenser	Re-loading the dishes properly.
The dishes are not drying	Improper loading	Load the dishwasher as suggested in the directions.
	Dishes are removed too soon	Do not empty your dishwasher immediately after washing. Open the door slightly so that the steam can come out. Take out the dishes until the inside temperature is safe to touch. Unload the lower basket first to prevent the dropping water from the upper basket.

Problem	Possible Causes	What To Do
The dishes are not drying	Wrong program has been selected.	With a short programme, the washing temperature is lower, decreasing cleaning performance. Choose a programme with a long washing time.
	Use of cutlery with a low-quality coating.	Water drainage is more difficult with these items. Cutlery or dishes of this type are not suitable for washing in the dishwasher.

• Error codes

When some malfunctions come on, the appliance will display error codes to warn you:

Codes	Meanings	Possible Causes
E1	Longer inlet time.	A flow meter, drain valve, or pump failure, it should be repaired by a qualified worker.
E3	Not reaching required temperature	Heating tube or thermistor abnormal, it should be repaired by a qualified worker.
E4	Overflow.	Some element of dishwasher leakage.
E9	Touch button adhesion	Water or other material in the key area causes E9 or it should be repaired by a qualified worker.
E8	Communication anomaly	It should be repaired by a qualified worker.
EF	Water tank float anomaly	It should be repaired by a qualified worker.
ER	Water tank float anomaly	It should be repaired by a qualified worker.

WARNING

- If overflow occurs, turn off the main water supply before calling a service.
- If there is water in the base pan because of an overflow or small leak, the water should be removed before restarting the dishwasher.

• Technical information

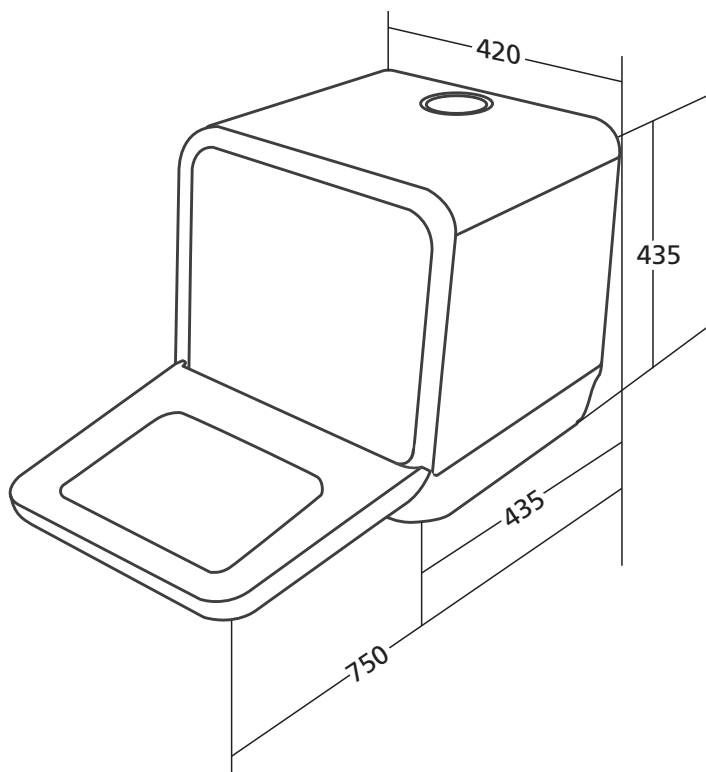

Height	435mm
Width	420mm
Depth	435mm
Voltage connected Load	see rating label
Water pressure	0.04 - 1.0MPa
Power supply	see rating label
Capacity	3 place settings