

HYUNDAI
POWER PRODUCTS



PETROL MULTI-TOOL

HYMT331 HYBC331

HY3300 POLE SAW

HY3300 HEDGE TRIMMER

Instruction Manual

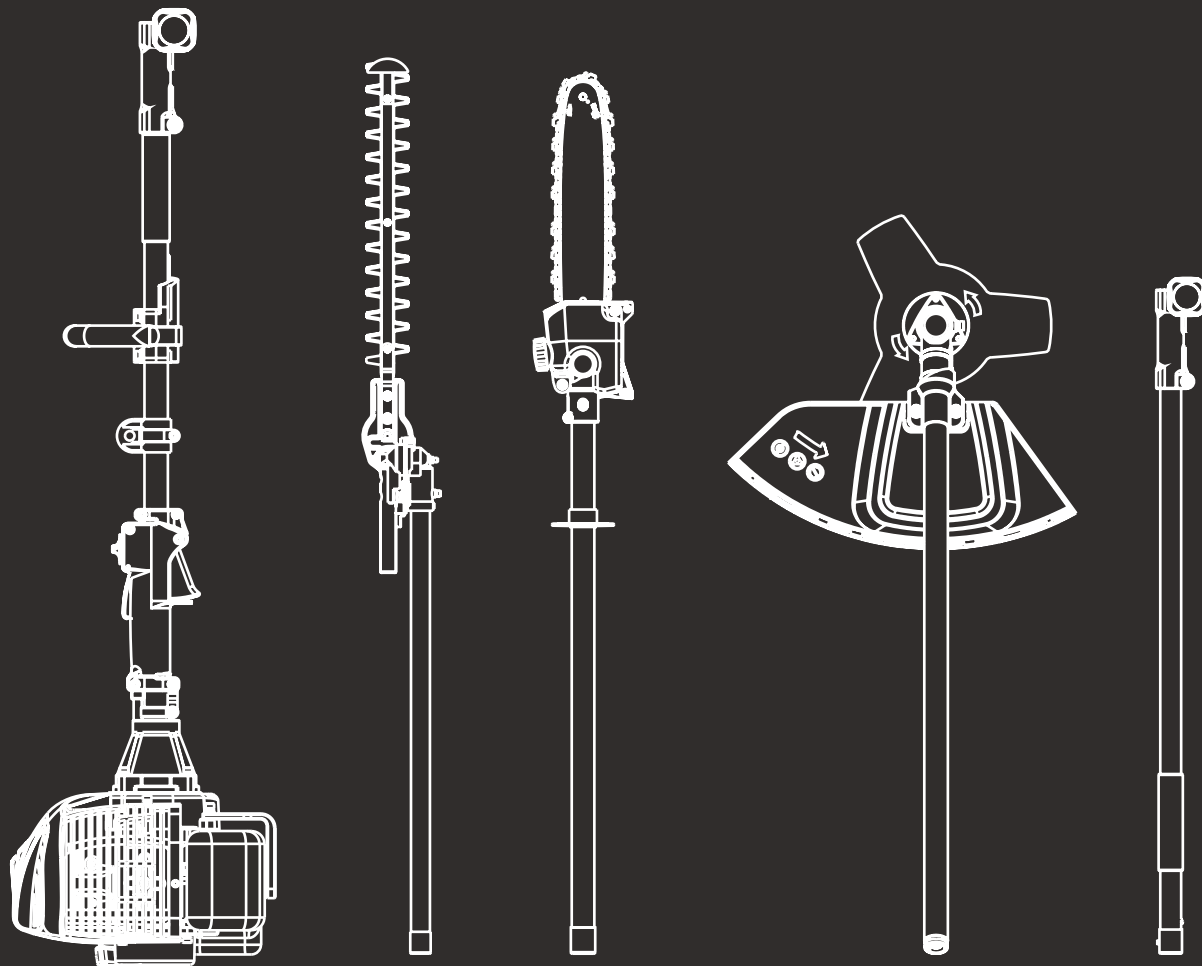

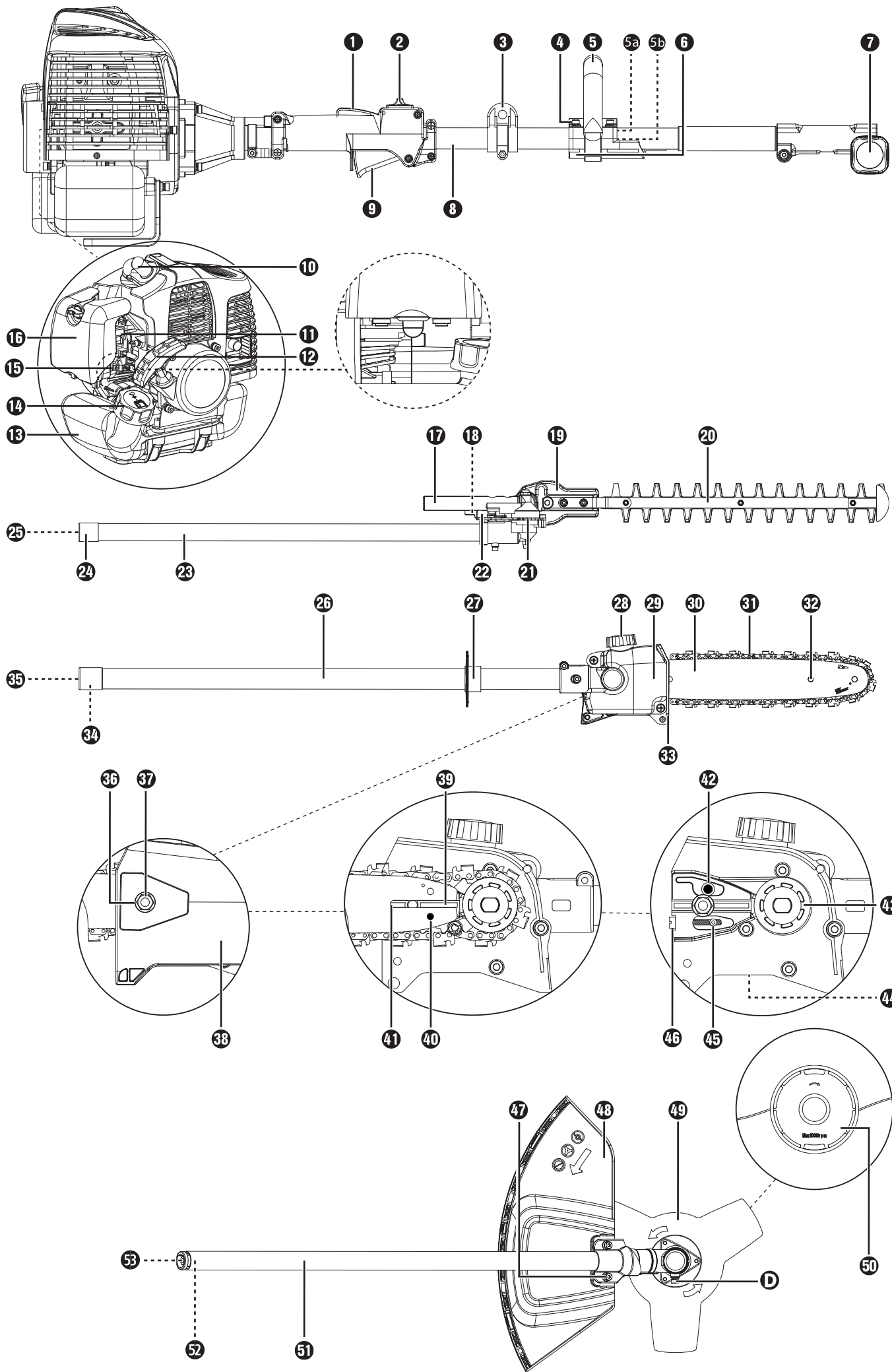

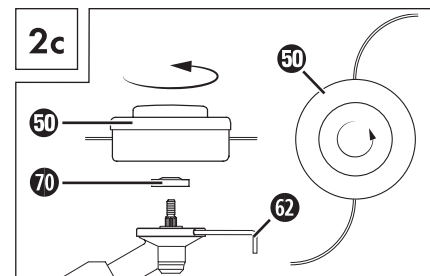
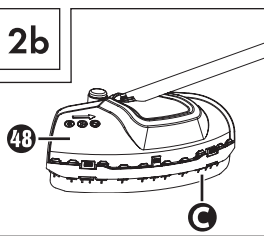
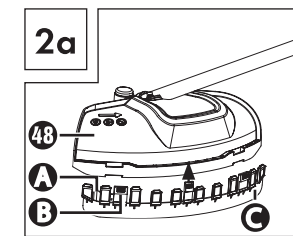
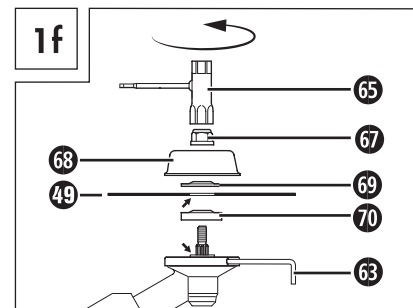
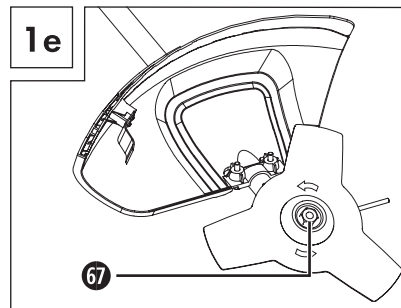
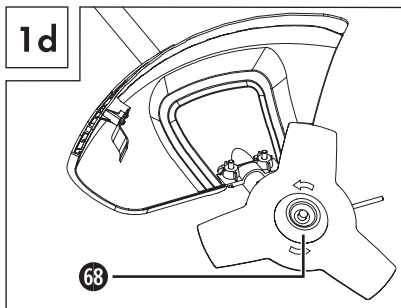
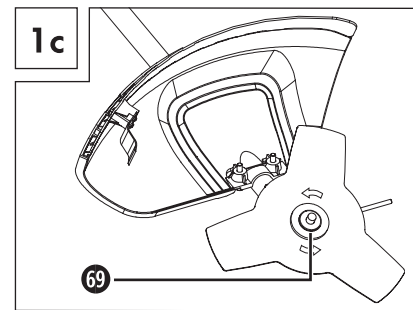
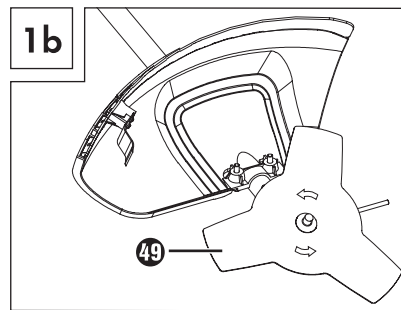
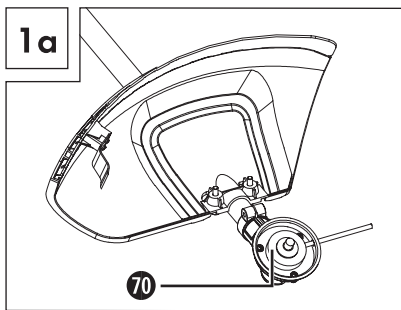
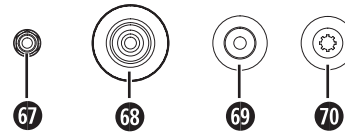
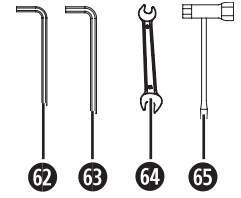
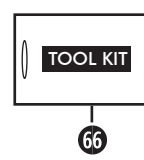
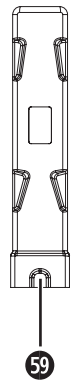
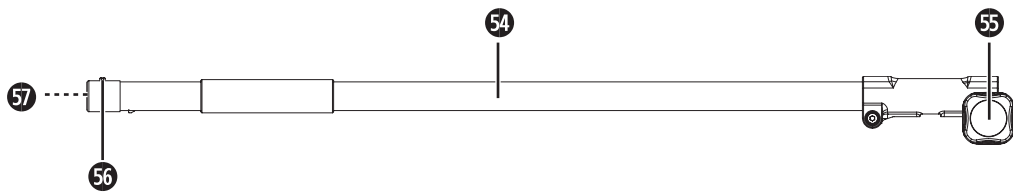

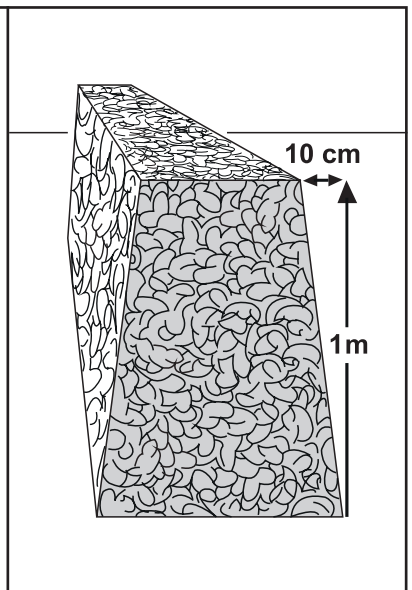
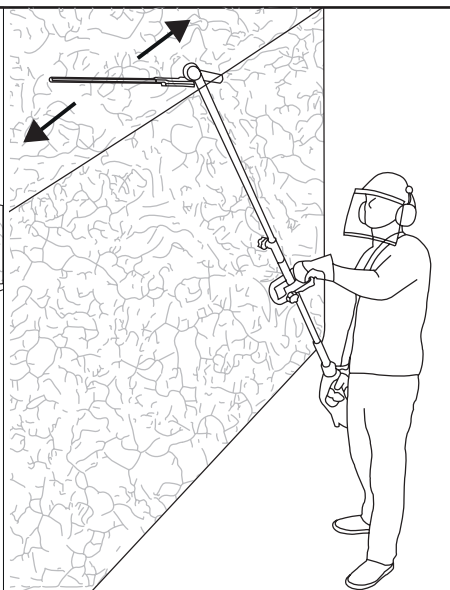
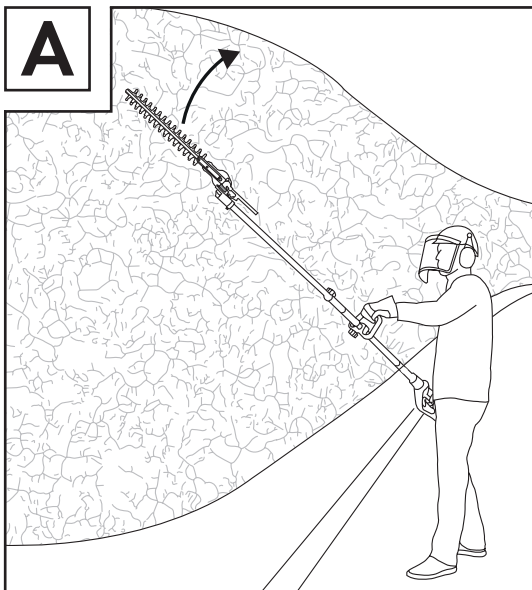
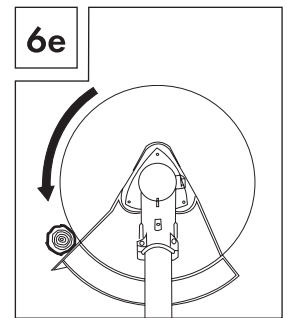
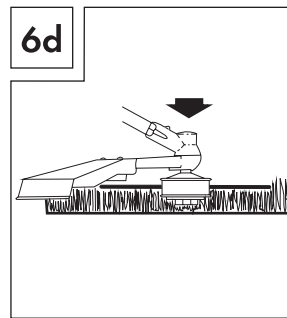
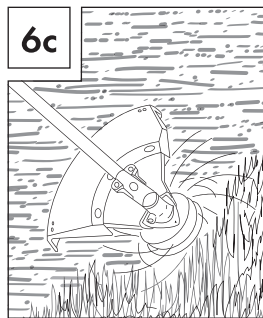
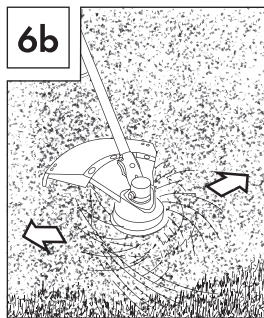
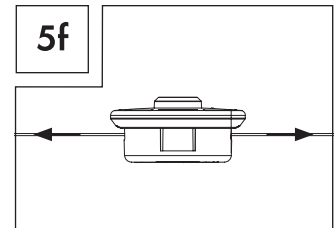
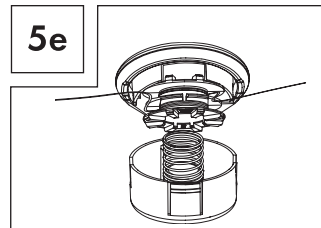
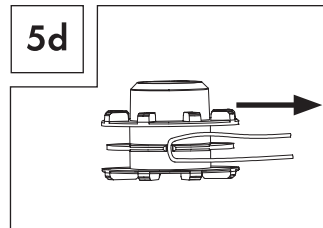
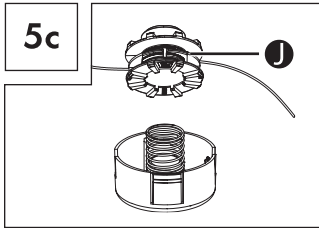
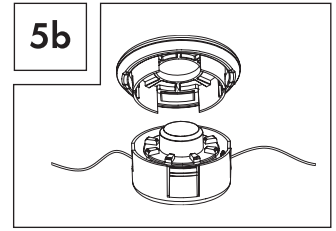
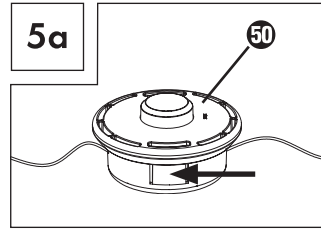
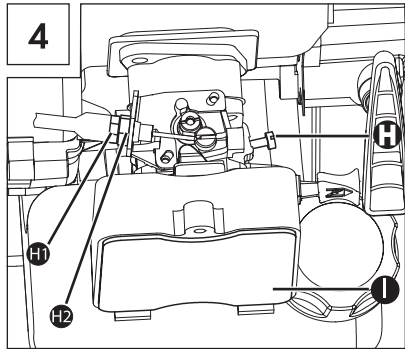
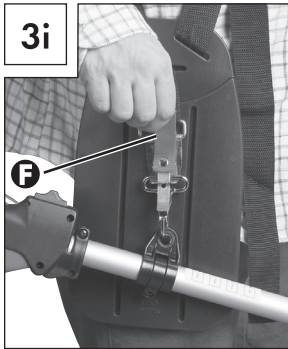
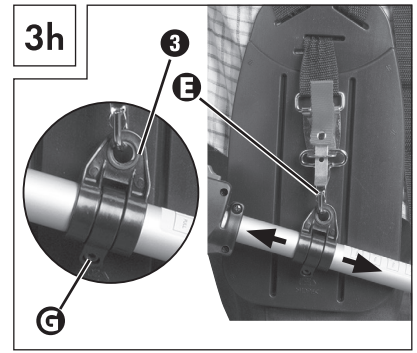
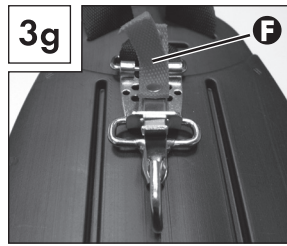
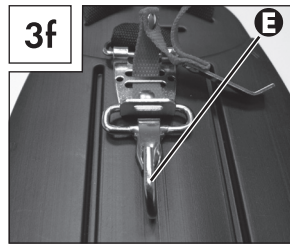
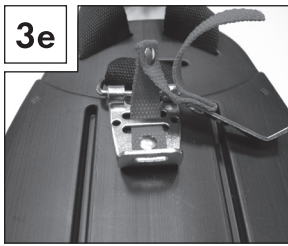

Contents

Introduction 2

Intended use	2
Features	2
Package contents	3
Technical data	3
Explanation of the symbols used	4

Safety instructions 6

Operational safety instructions for hedge trimmers	6
Supplementary safety instructions for hedge trimmers	7
Operational safety instructions for pole pruners	7
Precautions against kickback	8
Operational safety instructions for strimmers	8
Operational safety instructions for cutting blades	9
Safety devices/equipment	9

Before use 10

Attaching the round handle	10
Assembling the quick release mechanism	10
Fixing/attaching the carrying harness	10
Assembling the hedge trimmer	10
Removing the hedge trimmer	10
Swivelling the hedge trimmer	10
Mounting the saw chain and blade	10
Removing the saw chain	10
Tightening and checking the saw chain	11
Lubricating the chain	11
Sharpening the saw chain	11
Attaching the extension attachment	11
Fitting/removing the protective guard	11
Installing/replacing the cutting blade	11
Installing/replacing the strimmer	12
Putting on the carrying harness	12
Setting the cutting height	12
Fuel and oil	12

Use 12

Starting when the engine is cold	12
Starting when the engine is hot	12
Working with the hedge trimmer	13
Cutting techniques	13
Working with the pole pruner	13
Sawing techniques	13
Working safely	14

Transport 14

Cleaning 14

Maintenance 14

Storage and transportation 15

Troubleshooting 16

Engine unit	16
Pole pruner	16
Hedge trimmer	16

Maintenance intervals

Pole pruner	16
Hedge trimmer	16

Ordering Spare Parts 16

Disposal 17

Warranty 17

Contact Us 18

Declaration Of Conformity 19

5-IN-1 PETROL MULTI-TOOL

Introduction

The operating instructions are a part of this product. They contain important information about safety, usage and disposal. Before using the product, please familiarise yourself with all operating and safety instructions. Use the product only as described and for the range of applications specified. Please also pass these operating instructions on to any future owner.

Intended use

Long-handled hedge trimmer

This appliance is intended for the cutting and trimming of hedges, bushes and flowering shrubs in the home environment. This is a hand-held appliance with an integrated engine unit with linear reciprocating cutting blades.

⚠ WARNING!

- ▶ Hedge trimmers are not suitable for use by children.

Pole pruner

This appliance is intended for trimming branches in trees.

3-section cutting blade/stripper

Use with the 3-section cutting blade: for cutting high grass, undergrowth and light scrub.

Use with stripper: for cutting grass and small weeds.

Extension attachment

⚠ CAUTION!

- Do not use the extension attachment/boom 54 in combination with the 3-section cutting blade/stripper attachment!

Any other use that is not expressly permitted in these operating instructions may damage the appliance and represents a serious risk for the user. Please make sure that you pay attention to the restrictions in the safety instructions. Comply with all national regulations which may restrict the use of the machine. Any other uses of or modification to the appliance is deemed to be improper and carries the risk of serious personal injury. Not intended for commercial use.

PROHIBITED APPLICATIONS!

Due to the physical risk posed to the user, the appliance may not be used to perform the following activities: cleaning footpaths and as a shredder for shredding tree and hedge sections. Furthermore, the appliance may not be used to level ground elevations such as molehills. For safety reasons, the appliance may not be used as a drive unit for any other devices. The user, not the manufacturer, is liable for any resulting damage or injuries of any kind.

Features

Engine unit

- 1 Safety lock-out
- 2 On/Off switch
- 3 Carrying lug
- 4 4 x mounting bolts (with snap ring, washer and nut)
- 5 Round handle
- 5a Rubber ring
- 5b Pin
- 6 Barrier bar
- 7 Screw grip
- 8 Boom
- 9 Throttle control
- 10 Spark plug connector
- 11 Choke lever
- 12 Starter pull cord
- 13 Fuel tank
- 14 Filler cap
- 15 Fuel pump (primer)
- 16 Air filter housing cover

Hedge trimmer attachment

- 17 Handle
- 18 Lock/release
- 19 Gear housing
- 20 Cutter bar
- 21 Base plate (hedge trimmer)
- 22 Control lever
- 23 Front boom (hedge trimmer)
- 24 Locking pin
- 25 Drive shaft

Pole pruner attachment

- 26 Front boom (pole pruner)
- 27 Safety ring
- 28 Oil filler cap
- 29 Oil tank
- 30 Blade
- 31 Saw chain
- 32 Bench grinder support
- 33 Stop
- 34 Locking pin
- 35 Drive shaft
- 36 Nut
- 37 Thread
- 38 Sprocket cover
- 39 Blade guide
- 40 Blade hole
- 41 Guide rail
- 42 Oil dispenser
- 43 Chain sprocket
- 44 Oil adjusting screw
- 45 Chain tensioner pin
- 46 Chain tensioner screw

Strimmer/cutting blade attachment

- 47 2 x bolts (with snap ring, washer and nut)
- 48 Blade guard
- 49 3-section cutting blade
- 50 Strimmer with cutting filament
- 51 Front boom (strimmer/3-section cutting blade)
- 52 Locking pin
- 53 Drive shaft

Extension attachment

- 54 Boom
- 55 Screw grip
- 56 Locking pin
- 57 Drive shaft

Accessories

- 58 Carrying strap
- 59 Protective cover for blade
- 60 Chain guard
- 61 Oil/petrol mixing canister
- 62 Hex key M4
- 63 Hex key M5
- 64 Open-ended spanner SW 8/10
- 65 Spark plug wrench/flat-blade screwdriver
- 66 Tool bag
- 67 Nut M10 x 1.2 (left-hand thread)
- 68 Pressure plate cover
- 69 Pressure plate
- 70 Drive plate

Package contents

- 1 engine unit
- 1 hedge trimmer attachment (hereinafter hedge trimmer)
- 1 pole pruner attachment (hereinafter pole pruner)
- 1 strimmer/cutting blade attachment
- 1 extension attachment
- 1 handle with barrier bar
- 1 strimmer with cutting filament
- 1 cutting filament (filament Ø: 2.4 mm/filament length: 4 m)
- 1 3-section cutting blade
- 1 Carrying harness
- 1 chain guard
- 1 blade guard
- 1 oil/petrol mixing canister
- 1 tool bag
- 1 M4 hex key
- 1 M5 hex key
- 1 spark plug wrench/flat-blade screwdriver
- 1 SW 8/10 open-ended spanner
- 1 operating instructions

Technical data

Engine unit:

Engine type:	2-stroke engine, air-cooled, chrome cylinder
Engine output (max.):	1.45 kW/ 2.0 hp
Cylinder capacity:	51.7 cm ³
Engine idle speed:	3000 min ⁻¹ (rpm)
Max. engine speed	
with 3-section cutting blade:	9200 min ⁻¹ (rpm)
with strimmer:	8700 min ⁻¹ (rpm)
with chainsaw:	9200 min ⁻¹ (rpm)
with hedge trimmer:	9200 min ⁻¹ (rpm)
Max. cutting speed	
with 3-section cutting blade:	6900 min ⁻¹ (rpm)m
with strimmer:	6525 min ⁻¹ (rpm)
with chainsaw:	20 m/s
with hedge trimmer:	1550 min ⁻¹ (rpm)
Ignition:	electronic
Drive:	centrifugal clutch

Weight: (power unit empty tank):	approx. 5.6 kg
Fuel tank capacity:	1200 cm ³
Spark plug:	CDK L8RTC

Fuel consumption at	
max. engine performance:	0.6 kg/h
Specific	
fuel consumption	
at max. engine performance:	446 g/kWh

Hedge trimmer:

Cut length:	425 mm
Tooth spacing:	20 mm
Weight	
(ready for use):	approx. 2.119 kg

Pole pruner attachment:

Weight (ready for use):	approx. 1.1 kg
Oil tank, recommended fill level:	140 cm ³
Cut length:	approx. 260 mm
Blade:	10 inch
Saw chain:	10 inch

Strimmer/cutting blade attachment:

Strimmer with cutting filament:

Nylon line cutting circle Ø:	430 mm
Nylon line length:	4.0 m
Nylon line Ø:	2.4 mm

3-section cutting blade:

Metal blade cutting	
diameter Ø:	255 mm

Noise and vibration information:

Noise measurement value determined in accordance with ISO 22868, EN 10517. The A-rated noise level of the power tool is typically as follows:

Hedge trimmer:

Sound pressure level L_{pA} :	99.47	dB(A)
Uncertainty K_{WA} :	2.5	dB
Sound power level L_{WA} :	110.05	dB(A)
Guaranteed sound power level L_{WA} :	114	dB(A)
Uncertainty K_{WA} :	2.5	dB

Pole pruner:

Sound pressure level L_{pA} :	99.5	dB(A)
Uncertainty K_{WA} :	2.5	dB
Sound power level:	111.54	dB(A)
Uncertainty K_{WA} :	2.5	dB

3-section cutting blade:

Sound pressure level L_{pA} :	93.24	dB(A)
Uncertainty K_{PA} :	2.5	dB
Sound power level L_{WA} :	105.52	dB(A)
Uncertainty K_{WA} :	2.5	dB

Strimmer:

Sound pressure level L_{pA} :	94.74	dB(A)
Uncertainty K_{PA} :	2.5	dB
Sound power level L_{WA} :	105.62	dB(A)
Uncertainty K_{WA} :	2.5	dB



Wear ear protectors to prevent hearing damage!

Vibration values (vector total of three directions) determined in accordance with EN 11806-1, EN ISO 10517, EN ISO 11680-1:

Hedge trimmer:

Vibration on the front handle: vibration emission value
 $a_{h,D} = 5.165 \text{ m/s}^2$
 Uncertainty $K = 1.5 \text{ m/s}^2$

Vibration on the rear handle: vibration emission value
 $a_{h,D} = 8.95 \text{ m/s}^2$
 Uncertainty $K = 1.5 \text{ m/s}^2$

Pole pruner:

Vibration on the front handle: vibration emission value
 $a_{h,D} = 7.41 \text{ m/s}^2$
 Uncertainty $K = 1.5 \text{ m/s}^2$

Vibration on the rear handle: vibration emission value
 $a_{h,D} = 7.993 \text{ m/s}^2$
 Uncertainty $K = 1.5 \text{ m/s}^2$

Strimmer:

Vibration on the front handle: vibration emission value
 $a_{h,D} = 7.09 \text{ m/s}^2$
 Uncertainty $K = 1.5 \text{ m/s}^2$

Vibration on the rear handle: vibration emission value
 $a_{h,D} = 12.85 \text{ m/s}^2$
 Uncertainty $K = 1.5 \text{ m/s}^2$

3-section cutting blade:

Vibration on the front handle: vibration emission value
 $a_{h,D} = 7.6 \text{ m/s}^2$
 Uncertainty $K = 1.5 \text{ m/s}^2$

Vibration on the rear handle: vibration emission value
 $a_{h,D} = 9.79 \text{ m/s}^2$
 Uncertainty $K = 1.5 \text{ m/s}^2$

NOTE

- ▶ The vibration level specified in these instructions has been measured in accordance with the standardised measuring procedure specified in EN ISO 11806-1, EN ISO 10517, EN ISO 11680-1 and can be used to make equipment comparisons. The specified vibration emission value can also be used to make an initial exposure estimate.

WARNING!

- ▶ The vibration level varies in accordance with use and may be higher than the value specified in these instructions in some cases. There is a risk of underestimation of the vibration load if the appliance is used regularly in this manner. To estimate the vibration load during a specific working period accurately, periods during which the appliance is switched off (or running, but not being used) must also be taken into account. This can significantly reduce the vibration load over the total working period.

WARNING!

- You can reduce the vibration risk, for example, the risk of Raynaud's phenomenon, by taking regular breaks during which you rub your hands together.

Explanation of the symbols used



Warning! Read the operating instructions before use!



Wear protective gloves!



Wear safety shoes!



Wear ear protection!



Wear a hard hat!



Wear protective goggles!



Important, hot parts. Keep a safe distance away!



1. Switch on the appliance



2. Fill fuel pump (primer)



3. Pull the choke lever



4. Pull the starter pull cord



Pull the choke lever



Press the fuel pump (primer) 6x



Mixing ratio: 40 parts petrol to 1 part oil



Semi-synthetic 2-stroke oil and unleaded petrol at 40:1 ratio.



Semi-synthetic 2-stroke oil and unleaded petrol at 40:1 ratio.

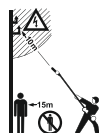

Risk of fatal electrical shock! Keep at least 10 m away from overhead power lines!



Attention! Falling objects.
Especially when cutting above head height.



Attention! Risk of injury due to running blades!



Keep a safe distance away!



General warning!



1. Push the pin on the front boom into the groove on the engine unit boom as far as the stop.
2. Once it is correctly inserted, the red line must match up with the one on the engine unit boom.
3. If this is not possible, pull on the starter pull cord to adjust the shaft.
ATTENTION! The On/Off switch **2** must be set to "0".



Protect the appliance from rain and moisture!



Max. 9000 min⁻¹ (rpm)



Attention! Left-hand thread.



Beware of flung objects!



Beware of kickback!



Caution! Risk of injury from rotating cutting blade!
Keep hands and feet away!



Attention - petrol is highly flammable!



Explosion hazard! Do not spill fuel!



Turn the appliance off and disconnect the spark plug before performing any maintenance work!



Attention! Risk of suffocation!



Caution! Poisonous CO vapours (carbon monoxide vapours)!
Do not use the appliance in confined spaces!



Warning! Do not use circular saw blades for the cutting blade function.



Add a little grease after every 20 hours of operation (gear grease)

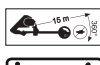

A distance of 15 metres must be maintained between the machine and third parties!



The cutting tool continues running after it is turned off (cutting blade/cutting filament)!



Sound power level LWA data in dB.



Fire, naked flames and smoking are prohibited!

Hedge Trimmer Safety

**IMPORTANT! READ CAREFULLY BEFORE USE!
KEEP FOR YOUR RECORDS.**

Operational safety instructions for hedge trimmers

NOTE

- ▶ The hedge trimmer is supplied completely assembled.
- ▶ Instructions and pictorial representations regarding the settings and use of the hedge trimmer and/or its controls, maintenance, lubrication by the user can be found in these instructions.
- ▶ Notes on the working position.
- ▶ Notes on the operating controls.
- ▶ Notes on the safe handling of fuel (see section "Preparation", point f).
- ▶ Notes on the recommended replacement or repair of parts or the Customer Service and specification of spare parts to be used, inasmuch as these affect the health and safety of the user, can be found in these instructions.
- ▶ The explanation of all graphical symbols, information, features and technical data as well as the procedure in the event of accidents and faults can be found in these instructions.
- ▶ Blocked tool: Remove any blockages from the cutter bar .

WARNING!

- Children must never use the hedge trimmer.
- **Stay alert, watch what you are doing and use common sense when operating the appliance. Do not use the appliance while you are ill, tired or under the influence of drugs, alcohol or medication.** A moment of inattention while operating the appliance may result in serious personal injury.
- Avoid improper use. Use the machine only as described under "Intended use".



Familiarise yourself with the operating instructions before you operate the appliance.

Preparation

- THE HEDGE TRIMMER CAN CAUSE SERIOUS INJURIES! Read the instructions on correct handling, preparation, maintenance, starting and stopping the hedge trimmer very carefully. Familiarise yourself with all manual controls and the proper use of the hedge trimmer.
- Children must never use the hedge trimmer.
- Beware of overhead power lines.
- Do not use the hedge trimmer while anyone, especially children, are in the vicinity.
- Wear appropriate clothing! Do not wear loose clothing or jewellery which could get caught in moving parts. We recommend wearing heavy-duty gloves, non-slip footwear and goggles.
- Handle fuel carefully. It is highly flammable and the vapours are explosive. The following points should be followed:
 - Use only specially-designed containers.
 - Never open the tank filler cap or top up the petrol tank while the motor is running or hot. Allow the motor and the exhaust components to cool down before refuelling.

- Do not smoke.
- Refuel outside only.
- Never store the hedge trimmer or the fuel tank in a room where there is an open flame, for example in a hot water boiler.
- If the petrol has overflowed, do not attempt to start the engine. Remove the machine from the fuel-contaminated area and let petrol evaporate before restarting.
- Always replace the filler cap after refuelling and close it securely.

g) If the cutting unit comes in contact with a foreign object or if the operating noise increases or the hedge trimmer starts to vibrate abnormally, stop the engine and allow the hedge trimmer to come to a standstill. Pull the spark plug connector off the spark plug and take the following action:

- check for damage;
- check for loose parts and secure all the loose parts;
- replace damaged parts with equivalent parts or have them repaired.



Wear ear protection!



Wear protective goggles!

- Familiarise yourself with the operation of the hedge trimmer so that you know how to stop immediately in an emergency.

Operation

- The engine is to be immobilised before:
 - cleaning or removal of a blockage;
 - inspection, maintenance or work on the hedge trimmer;
 - setting the working position of the cutting unit;
 - if the hedge trimmer is to be left unattended.
- Always make sure that the hedge trimmer is in the proper working position before the engine is started.
- During operation of the hedge trimmer, always ensure that you have firm footing, especially when using a ladder.
- Do not use the hedge trimmer if it has a defective or badly worn cutting unit.
- To minimise the risk of fire, ensure that the engine and the silencer are free of residues, leaves or leaked lubricant.
- Ensure that all supplied handles and safety guards are mounted when operating the hedge trimmer. Never attempt to operate an incompletely assembled hedge trimmer or a hedge trimmer with non-approved modifications.
- Always use both hands if the hedge trimmer is equipped with two handles.
- Always familiarise yourself with your environment and be aware of potential dangers that you may not be able to hear because of the noise of the hedge trimmer.

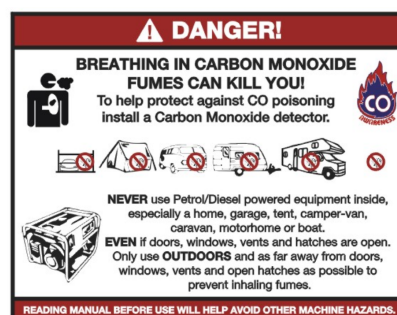

Maintenance and storage

- If the hedge trimmer is shut down for maintenance, inspection or storage, switch off the engine, pull the spark plug connector off the spark plug and ensure that all rotating parts have come to a standstill. Allow the machine to cool down before carrying out an inspection, settings, etc.
- Store the hedge trimmer where the petrol vapours cannot come into contact with flames or sparks. Always allow the hedge trimmer to cool down before storage.
- When transporting or storing the hedge trimmer, cover the cutting unit with the protective cover for the cutting unit.

Supplementary safety instructions for hedge trimmers

Environmental safety

- Only operate the hedge trimmer in daylight or good artificial light.
- While trimming, ensure that you do not come into contact with objects such as fence wire or plant supports. They could cause damage to the cutter bar 20. Inspect the hedge to be cut carefully and remove any wires or other foreign bodies.
- Be aware of your environment and all possible hazards that you may be unable to hear while cutting the hedge.

⚠ DANGER!

- In the event of imminent danger or an emergency, switch off the engine immediately.

Electrical safety

- Hold the power tool only by the insulated grips as the cutting blades could come into contact with hidden power lines. Contact between the blades and a live wire may make exposed metal parts of the power tool live and could give the operator an electric shock.

Personal safety

- During operation, no other person or animal may be within a radius of 15 metres. The operator is responsible for third parties within the working area.
- During operation, ensure that you have proper footing and balance at all times, especially when used on steps or ladders.
- Never touch the cutter bar 20 of the hedge trimmer.
- Keep your hands away from the cutting blades. Do not attempt to clear clippings or hold onto the material to be cut while the blades are still in motion. Remove any jammed clippings only when the appliance has been switched off. A moment of inattention while operating the hedge trimmer may result in serious personal injury.
- Wait until the tool has come to a standstill before putting it down.

Use and handling

⚠ CAUTION!

- Between tasks or after completion of a task, do not set the cutter bar 20 down on its tip as this could cause damage to the cutter bar 20.
- Before use, always check that the blades, the blade screws and other parts of the cutting tool are not worn or damaged. Never work with a damaged or heavily worn blade.
- After making settings to the working angle, check whether both setting levers are clicked firmly into place. If one of the setting levers remains open, the second could be unintentionally be released by a branch and the cutter bar 20 could swing down.
- Never use the hedge trimmer with defective or missing safety devices.
- Never grasp the hedge trimmer by the safety guards.

- Carry the hedge trimmer by the front handle when switched off, with the cutter bar facing away from your body. When transporting or storing the trimmer, always put on the protective cover. Careful handling of the appliance reduces the likelihood of accidental contact with the moving blades.
- Store the hedge trimmer in a dry, high or closed space out of the reach of children.
- Do not attempt to repair the equipment unless you have received the necessary training.
- For safety's sake, change worn or damaged parts.

⚠ DANGER!

- In the event of imminent danger or an emergency, switch off the engine immediately.

Pole Saw Safety

Operational safety instructions for pole saws

⚠ CAUTION! RISK OF INJURY!

- To prevent injuries, never touch the appliance above the safety ring 27 while it is running!

Preparation

- Always wear a hard hat, ear protection and safety gloves. Also wear safety goggles to prevent splashes of oil or sawdust from getting into your eyes. Wear a dust mask to protect yourself from dust.
- Wear sturdy, non-slip boots.
- Do not use the appliance in the rain.
- Before use, check the appliance's safety condition, especially the blade and the saw chain.
- Do not use the appliance near power lines. Maintain a minimum distance of 10 m to above-ground power lines.

Electrical safety

- Do not use the appliance in a potentially explosive environment containing flammable liquids, gases or dusts. The sparks generated by the machine could ignite the vapours or gases.
- Appliances with defective switches must be repaired immediately to avoid damage or injuries.

Personal safety

- Never use the appliance while standing on a ladder.
- Do not lean too far forward while using the appliance. Ensure you are standing firmly and keep your balance at all times. Use the supplied carrying harness to spread the weight evenly on the body.
- To avoid injuries due to falling branches, do not stand under the branches that you want to cut off. Be aware of branches that may spring back and cause injuries. Work at an angle of approximately 60°.
- Be aware that an appliance kickback can occur.
- Keep an eye not only on the branches being cut, but also on fallen material, to avoid tripping.
- Cover the guide rail and the chain with the cover during transport and storage.
- Avoid unintentional starting of the appliance.
- Store the appliance out of the reach of children. Only those who are fully acquainted with the operating instructions and the appliance itself may operate the appliance.

Use and handling

- Never start the appliance before the blade, saw chain and sprocket covers have been fitted correctly.
- Do not cut any wood that is lying on the ground and do not attempt to saw roots that are protruding from the soil. Avoid immersing the saw chain in the soil at all costs, as this could blunt the saw chain.
- If the appliance accidentally comes into contact with a solid object, turn off the engine immediately and inspect the appliance for damage.
- After 30 minutes of work, take a break of at least one hour.
- If the pole pruner is shut down for maintenance, inspection or storage, switch off the engine, pull the spark plug connector off the spark plug and ensure that all rotating parts have come to a standstill. Allow the machine to cool down before carrying out an inspection, settings, etc.
- Service the appliance carefully. Check for misalignment or binding of moving parts, breakage of parts and any other damage that may impair the tool's operation. If damaged, have the power tool repaired before use. Many accidents are caused by poorly-maintained tools.
- Keep cutting tools sharp and clean. Properly maintained cutting tools with sharp cutting edges are less likely to bind and are easier to control.
- Have the appliance checked by qualified specialists. Use only the replacement parts recommended by the manufacturer.

Precautions against kickback

⚠ CAUTION KICKBACK!

- ▶ Be aware of the danger of kickback when working with the appliance. There is a risk of personal injury. You can avoid kickbacks by being careful and using the correct sawing technique.
- Contact with the tip of the rail may in some cases lead to an unexpected rearwards reaction resulting in the guide rail flying upwards towards the operator (see fig. A).

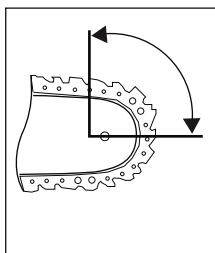

Fig. A

- Kickbacks can occur if the tip of the guide rail touches an object or if the wood bends and the saw chain gets caught in the cut (see fig. B).

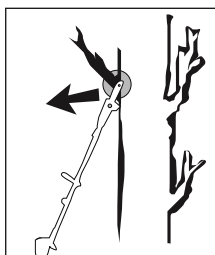

Fig. B

- If the saw chain jams in the upper edge of the guide rail, the rail can kick back violently towards the operator.

- Any such reaction can lead to you losing control over the saw and possibly injuring yourself. Do not rely solely on the chainsaw's built-in safety devices. As the user of a chainsaw, you can take a number of measures to avoid accidents and injury. A kickback is caused by incorrect use or misuse. It can be avoided by taking proper precautions, as described below:
- **Hold the saw firmly with both hands, with your thumb and fingers around the handles of the chainsaw. Position your body and arms so you can withstand kickback forces.** If suitable measures are taken, the operator can control the recoil forces. Never let go of the chainsaw.
- **Avoid any abnormal posture and do not saw over shoulder height.** This will prevent inadvertent contact with the tip of the rail and allows a better control of the chainsaw in unexpected situations.
- **Always use the replacement rails and saw chains specified by the manufacturer.** Incorrect replacement rails and saw chains can lead to a tearing of the saw chain and/or kickback.
- **Follow the manufacturer's instructions for sharpening and maintenance of the saw chain.** Setting the depth limiter too low can increase the risk of kickback.
- **Do not saw with the tip of the blade.** This can lead to a kickback.
- **Ensure that there aren't any objects on the ground that you can trip over.**

Operational safety instructions for trimmers

Preparation

- Wear close-fitting clothes that offer good protection, such as long trousers, sturdy work shoes, heavy-duty protective gloves, a hard hat, a protective mask for your face or safety goggles to protect your eyes and good ear plugs or some other hearing protection against noise.
- Always use the enclosed shoulder strap.
- Always ensure that the handles are dry and clean and that no petrol mixture is present.
- Before working, check the area for objects such as pieces of metal, bottles, stones, etc, that could get thrown up and cause injuries to the user.
- Before starting the engine, make sure that the trimmer is not in contact with any obstacles.
- Do not use the appliance until you have familiarised yourself with its use.

Electrical safety

- Never use the appliance near highly flammable liquids or gases, either in closed rooms or in the open. This may result in explosions and/or fire.
- Do not work with a damaged or incomplete appliance or an appliance that has been modified without the consent of the manufacturer. Never use the unit with defective protective equipment. Do not use the appliance if it has a defective on/off switch. If the appliance has been dropped, check for significant damage or defects.

Personal safety

- This appliance may only be operated, adjusted and maintained by appropriately trained individuals and adults.
- If you are not familiar with the appliance, practice handling the appliance while the engine is off.
- Do not touch the exhaust.
- Do not operate the appliance under the influence of alcohol or drugs.
- Always hold the appliance with both hands. Your thumbs and fingers should encircle the handles.

- Work posture: Do not operate the appliance in an uncomfortable position, when you are unbalanced, with arms fully stretched or with only one hand.
- Always ensure that you have a solid and firm stance.
- Do not use the appliance if bystanders or animals are in the direct vicinity. Maintain a minimum distance of 1.5 metres between the operator and other people or animals when trimming. Maintain a minimum distance of 30 metres between the operator and other people or animals when mowing down to the ground.
- When mowing on a slope, always stand at a lower level than the cutting tool. Never cut or trim on an icy, slippery hill or slope.
- Any modifications to the product may risk personal safety and void the manufacturer's warranty.
- Children should be supervised to ensure that they do not play with the appliance.
- Do not use the appliance if it is damaged or if there are visible defects.

Use and handling

- Use the appliance only for its intended purpose: cutting grass, mowing, pruning branches, cutting and trimming hedges and bushes.
- Do not use the appliance for extended periods; take regular breaks.
- Ensure that screws and connecting elements are firmly tightened. Never operate the appliance if it is not correctly adjusted, incomplete or if it is not properly assembled.
- Open the fuel tank slowly in order to allow any pressure which may have built up in the tank to dissipate. To prevent the risk of fire, move at least 3 metres away from the refuelling area before starting the appliance.
- Guide the strimmer to the desired height. Avoid contact with small objects (e.g. stones) when using the strimmer.
- Always hold the strimmer on the ground when the appliance is in operation.
- Do not use the appliance unless the appropriate protective guard has been installed and is in good condition.
- Do not use any other cutting tools. For your safety, only use the accessories and additional devices that are indicated in the operating instructions. The use of parts other than those recommended in the operating instructions, or other accessories, can put you at risk of injury.
- Always trim and cut using the high speed range. Do not let the engine run at a low speed when starting to mow or trim.
- When starting and operating the appliance, ensure that it does not come into contact with the ground, stones, wire or other foreign material. Switch off the appliance before you put it down.
- Switch off the appliance before you put it away.
- Always turn the engine off before working on the cutting tool.

Operational safety instructions for cutting blades

Preparation

- The cutting blade flings objects and soil with great force. These can blind or cause other injuries. Wear eye, face and leg protection. Always remove objects from the work area before using the cutting blade.
- The cutting blade continues running after the throttle lever has been released. A running-down cutting blade can inflict cuts to yourself or other people standing nearby. Turn the engine off and make sure that the cutting blade has come to a complete stop before performing any work on the cutting blade.

Personal safety

- The appliance can blind and cause injuries to bystanders. Maintain a minimum distance of 1.5 metres in all directions between the appliance and other people or animals.

Use and handling

- Do not use the appliance if any of the cutting blade accessories have not been properly installed.
- The cutting blade can kick back from objects with force. This can cause injuries to your arms and legs. If the appliance comes into contact with a foreign body, immediately shut down the engine and wait until the cutting blade has come to a complete stop. Check the cutting blade for damage. Always replace the cutting blade if it is bent or cracked.

Safety devices/equipment

The relevant plastic protective guard for the cutting blade or filament operation must be installed when working with the appliance in order to prevent objects from being flung away.

WARNING!

- Never mow/trim while other individuals, especially children or animals, are in the vicinity.
- Maintain a safety distance of 1.5 m. Turn off the appliance immediately if this distance is not maintained.

CAUTION! RISK OF POISONING!

- Exhaust gases, fuels and lubricants are toxic. Exhaust gases must never be inhaled.

WARNING!

- Petrol is highly flammable. Store petrol only in the containers provided.
- Refuel only outdoors and do not smoke.
- The filler cap must not be opened and refuelling must not take place while the engine is running or when the appliance is hot.
- Do not attempt to start the engine if the petrol has overflowed. Instead, remove the appliance from the area polluted by petrol. Do not attempt to restart the appliance until the petrol fumes have dissipated.
- For safety reasons, the petrol tank and filler cap must be replaced if they are damaged.

Limit the noise generation and vibrations to a minimum!

- Only use appliances that are in good condition.
- Maintain and clean the appliance on a regular basis.
- Adapt your working method to the appliance.
- Do not force the power tool.
- Have the appliance inspected if necessary.
- Switch the appliance off when not in use.
- Wear protective gloves.

Before use

⚠ CAUTION!

- Always wear non-slip footwear and appropriate safety clothing such as protective gloves, a hard hat, a protective mask and safety goggles as well as hearing protection.
- Check the area in which the appliance is to be used and remove any objects that may be caught and slung away.
- Before use and after dropping or other impacts, always visually inspect the appliance to check whether the cutting tool, mounting bolts and the entire cutting unit are damaged. Worn or damaged cutting tools and mounting bolts must be replaced.
- Always carry out a visual inspection before use to check whether the cutting tools are worn or damaged. To prevent imbalance, worn or damaged cutting tools and mounting bolts should be replaced only as complete sets.

Attaching the round handle

- ◆ Start by fitting the rubber ring **5a** on the boom **8**.
- ◆ Attach the barrier bar **6** onto the rubber ring **5a** from below, as shown in the diagram.

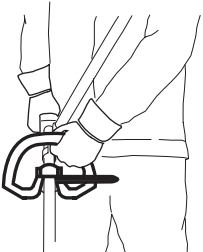

- ◆ The pin **5b** of the barrier bar **6** must be pushed into one of the two holes on the boom **8** to lock into place.
- ◆ Push the round handle **5** onto the rubber ring **5a** provided on the boom **8**.
- ◆ Insert the 4 mounting bolts **4** from above through the round handle **5** and fix them onto the barrier bar **6** with the 4 nuts.
- ◆ Tighten the screws **4**.

Assembling the quick release mechanism

- ◆ Hook in the carabiner and secure it with the red strap on the quick release mechanism (see figures). Pull on the red strap if you have to put down the appliance quickly.



Fixing/attaching the carrying harness

- ◆ Hook the carrying harness **58** into the carrying lug **3**.
- ◆ Adjust the length of the carrying harness **58** to your size so that the carrying lug **3** is at hip height when the strap is hooked in place.

Assembling the hedge trimmer

- ◆ Start by undoing the screw grip **7** on the boom **8** of the engine unit.

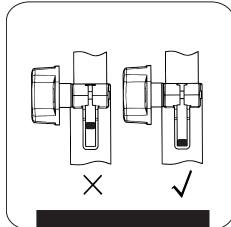
- ◆  Push the pin on the front boom **23** of the hedge trimmer into the groove on the engine unit boom **8** as far as the stop. Once it is correctly inserted, the red line must match up with the one on the engine unit boom.

- ◆ Tighten the screw grip **7**.

NOTE

- ▶ Assembly of the pole pruner/trimmer/3-section cutting blade/extension attachment is carried out in the same order.

Removing the hedge trimmer

- ◆ Undo the screw grip **7** and pull the front boom **23** of the hedge trimmer out of the engine unit boom **8**.

NOTE

- ▶ Removal of the pole pruner/trimmer/3-section cutting blade/extension attachment is carried out in the same order.

Swivelling the hedge trimmer

- ◆ Release the lock/release **18**.
- ◆ Press the control lever **22** and swivel the hedge trimmer into the desired position.
- ◆ Allow the control lever **22** to click into the recess in the base plate (hedge trimmer) **21**.

Mounting the saw chain and blade

⚠ WARNING!

- ▶ Wear protective gloves! There is a danger of injury from the sharp cutting teeth!

NOTE

- ▶ Pay close attention to the running direction of the saw chain **31** on the blade **30** and at the base plate (hedge trimmer)  SAW CHAIN.
- ▶ Depending on wear, the blade **30** can be turned.

- ◆ Undo the nut **35** using the open-ended spanner **64**.
- ◆ Remove the sprocket cover **38**.
- ◆ Lay the saw chain **31** over the blade **30** starting at the tip.
- ◆ Now fit the blade **30** and saw chain **31**.
- ◆ Lay the guide rail **41** over the blade guide **39**, while inserting the chain tensioner pin **45** in the blade hole **40**. At the same time, lay the saw chain **31** over the chain sprocket **43**.
- ◆ Now you can tighten the saw chain **31** (see section "Tightening and checking the saw chain").
- ◆ Replace the sprocket cover **38** and tighten the nut **35** gently.

Removing the saw chain

- ◆ You may have to loosen the saw chain **31** to remove the blade **30** and the saw chain **31** (see section "Tightening and checking the saw chain"). Follow these instructions in reverse order.

Tightening and checking the saw chain

⚠ WARNING!

- ▶ Wear protective gloves! There is a danger of injury from the sharp cutting teeth!
- ◆ Turn the chain-tensioner screw 46 in a clockwise direction using the flat-blade screwdriver 65 to increase the tension.
- ◆ The saw chain 31 must lie against the underside of the blade. Check whether the saw chain 31 can be drawn over the blade 30 by hand.

NOTE

- ▶ A new saw chain 31 stretches and must be tightened more frequently.

Lubricating the chain

- ◆ Remove the oil filler cap 28.
- ◆ Fill oil tank 29 with organic chain oil.
- ◆ The chain lubrication can be increased or decreased using the oil adjusting screw 44.
- ◆ Press and then turn the oil adjusting screw 44 clockwise to decrease the chain lubrication.
- ◆ Press and then turn the oil adjusting screw 44 anticlockwise to increase the chain lubrication.

⚠ WARNING!

- ▶ Never work without lubricating the chain first! If the saw chain runs dry, the cutting equipment may become irreparably damaged within a short time. Always check chain lubrication and oil level in the tank before starting work.

NOTE

- ▶ Use only saw chain oil. Preferably biodegradable. Do not use waste oil, motor oil, etc.
- ▶ While working, check whether the chain lubrication is working correctly.

Sharpening the saw chain

NOTE

- ▶ A bench grinder can be attached to the bench grinder support 32 for a secure grip during grinding.
- ▶ You will find detailed information on sharpening in a sharpening set, e.g. from Oregon.
- ▶ Alternatively, you can use an electrical saw chain sharpening device and follow the manufacturer's instructions.
- ▶ If you have any doubts about carrying out the work, the saw chain should be replaced.

Attaching the extension attachment

⚠ CAUTION!

- Do not use the extension attachment/boom 54 in combination with the 3-section cutting blade/trimmer attachment!

NOTE

- ▶ Use the extension attachment/boom 54 for working at greater heights.
- ◆ Fit the extension attachment/boom 54 between the engine unit and the hedge trimmer/pole pruner. The assembly is carried out in the same manner as for the attachments described previously.

Fitting/removing the protective guard

⚠ WARNING!

- When working with the 3-section cutting blade 49, the blade guard 48 must be fitted. The blade guard 48 is positioned under the metal panel of the boom 51. The blade guard 48 is now attached to the front boom 51 with the 2 screws 47. To do this, use the supplied hex key 63.

Cutting equipment

Protective equipment

3-section cutting blade 49

Blade guard 48

Strimmer 50

Blade guard 48 + cutting filament protective guard C

⚠ WARNING!

- ▶ Do not use any other cutting equipment apart from that which is supplied with the product. The use of any other cutting equipment or protective equipment is deemed to be improper and carries a significant risk of accidents.

Installing/replacing the cutting blade

- Fit/remove the 3-section cutting blade 49 as shown in figures 1a-1f.
- Find the hole in the drive plate 70, align it with the opposite hole and block it with the supplied hex key 62.
- Place the 3-section cutting blade 49 on the drive plate 70 (see fig. 1b). The inscription must be visible from above when holding the tool in the working position (see fold-out page). Both sides of the 3-section cutting blade 49 can be used.
- Fit the pressure plate 69 over the thread over the splined shaft (see fig. 1c).
- Fit the pressure plate cover 68 (see fig. 1d).
- Tighten the nut 67 with the spark plug spanner 65 anticlockwise **ACHTUNG! Left-hand thread!** (see fig. 1f).
- The 3-section cutting blade 49 is fitted with a plastic cover on delivery. This must be removed before use and refitted during periods when not in use.
- The plastic cover can now be removed.

⚠ CAUTION! SHARP EDGES, WEAR PROTECTIVE GLOVES

- Fit the cutting filament protective guard C on the protective guard 48.
- The cutting filament protective guard C must be fitted when working with the cutting filament. The cutting filament protective guard C (pre-fitted on delivery) is fitted as shown in figure 2a.
- Ensure that the cutting filament protective guard C is correctly clicked into place. There is a blade A on the inside of the cutting filament protective guard C. This is covered with a safety cover B (see fig. 2a.).
- Remove the safety cover B before starting work and replace it after finishing work.

⚠ CAUTION! SHARP EDGES, WEAR PROTECTIVE GLOVES

- To remove the cutting filament protective guard C from the protective guard 48, take a tool, such as a screwdriver, to carefully remove the three mounting pins.
ATTENTION! RISK OF INJURY!

Installing/replacing the strimmer

- Install/replace the strimmer **50** as displayed in figure 2c.
- Find the hole in the drive plate **70**, align it with the opposite hole and block it with the supplied hex key **65**.
- Screw the strimmer **50** onto the thread in an anticlockwise direction.

ATTENTION! Left-hand thread!

Putting on the carrying harness

NOTE

- The following adjustments can be made to make sure that you can work without becoming fatigued. The settings may vary depending on your body size.
- Before starting work, adjust the carrying harness **58** to suit your body size.
- Balance the appliance with the fitted cutting tool so that the cutting tool swings just over the ground without the need to move the appliance with your hands.

- 1.) Put on the carrying harness **58** and close the clasps so that they click into place (see fig. 3a).
- 2.) As shown in figure 3b, pull on the belt **58**, to position the carrying harness **58** centrally on your body and adjust the upper body size.
- 3.) To tighten the two shoulder straps, pull on the two shoulder straps as shown in figure 3c.
- 4.) To ensure to the correct position of the appliance on the carrying harness, pull the belt as shown in figure 3d.
- 5.) Hook in the carabiner **E** (see figs. 3e–3g) and secure it with the red strap **F** on the quick release mechanism.
- 6.) Now take the appliance and hang it so that the carrying lug **3** clicks into the carabiner **E**, as shown in figure 3h. The carrying lug **3** can also be moved by loosening the screw **G** and sliding it to achieve the optimum orientation of the appliance.

Setting the cutting height

- Put on the carrying harness **58** and hook in the appliance (see section "Putting on the carrying harness").
- Use the various belt straps on the carrying harness **58** to adjust the optimum working and cutting position (see section "Putting on the carrying harness").
- Perform a few circular movements without starting the engine in order to find the ideal shoulder strap length (see fig. 6a).
- The carrying harness **58** is equipped with a quick release mechanism. Pull on the red strap **F** if you have to release the appliance quickly (see fig. 3i).

CAUTION!

- Always use the carrying harness **58** when working with the device. Put on the carrying harness **58** as soon as you have started the engine and it is ticking over. Turn off the engine before removing the carrying harness **58**.

Fuel and oil

- Use semi-synthetic 2-stroke oil and unleaded petrol at 40:1 ratio. Mix the fuel mixture in accordance with the fuel mix table.
- Add the respective correct amounts of unleaded petrol and 2-stroke oil to the supplied oil/petrol mixing canister (see "Fuel mix table"). Then shake the canister well.

Fuel mix table

Mixing process: 40 parts petrol to 1 part oil

Petrol	2-stroke oil
0.5 litres	12.5 ml

Use

CAUTION!

- Please pay attention to the statutory provisions in the relevant noise protection regulations.

Before starting the appliance, always check that:

- The fuel system is not leaking.
- The protective equipment and cutting equipment is complete and in perfect working order.
- All screw connections are firmly tightened.
- All moving parts can move smoothly and freely.

Starting when the engine is cold

CAUTION!

- Never allow the starter pull cord to whip back. This could cause damage.

- 1.) Fill the fuel tank **13** (see also the section "Fuel and oil").
- 2.) Push the fuel pump (primer) **15** 6 times.
- 3.) Switch the On/Off switch **2** to "I".
- 4.) Pull the choke lever **11** into the position "I".
- 5.) Hold the appliance firmly and pull out the starter pull cord **12** to the point of first resistance. Now pull hard on the starter pull cord **12**. The appliance starts.
- 6.) If the engine does not start, repeat step 5.
- 7.) As soon as the engine is running, press first the safety lock-out **1** and then the throttle **9** to activate the automatic choke.

If the engine does not start after several attempts, read the "Troubleshooting guide" section.

CAUTION!

- Always pull the starter pull cord **12** straight out. Hold the handle of the starter pull cord **12** firmly when the starter pull cord **12** retracts. Do not allow the starter pull cord **12** to whip back.

NOTE

- At very high ambient temperatures, it is possible that even a cold engine has to be started without using the choke!

Starting when the engine is hot

(The appliance has been turned off for less than 15–20 minutes)

- 1.) Switch the On/Off switch **2** to "I".
- 2.) The choke lever **11** does not need to be pulled out to start a warm motor.
- 3.) Hold the appliance firmly and pull out the starter pull cord **12** to the point of first resistance. Now pull hard on the starter pull cord **12**. The appliance should start after 1–2 pulls. If the appliance still hasn't started after 6 pulls, repeat steps 1–7 under "Starting when the engine is cold".

Turning the engine off

Emergency stop sequence

If the appliance needs to be stopped immediately, turn the On/Off switch ② to "0".

Normal sequence

- Release the throttle lever ① and wait until the engine has slowed down to its idling speed. Then move the On/Off switch ② to "0".

⚠ CAUTION!

- The 3-section cutting blade must be stationary when the engine is idling. If the 3-section cutting blade is turning, adjust the carburettor!

Working procedures

Before using the appliance, practice all working techniques (see figs. 6a-6c) with the engine stopped.

Extending the cutting filament

To extend the cutting filament, run the engine at full speed and tap the strimmer ⑤ on the floor. The filament extends automatically. The knife ④ on the cutting filament protective guard ③ cuts the thread to the permissible length (see fig. 6d).

⚠ CAUTION!

- Grass/weed residues can get caught under the protective guard ④.
- Remove the remains using a scraper or similar item when the engine is switched off.

Various cutting methods

Trimming/mowing (3-section cutting blade or strimmer)

- Swing the appliance in a scything motion (see fig. 6a).
- Hold the cutting tool parallel to the ground and set the desired cutting height.

Low trimming (with strimmer)

- Hold the appliance with a slight incline to the ground (see fig. 6b). Always cut away from your body. Never pull the appliance towards you.

Short mowing (with strimmer)

- Short mowing removes all the vegetation right down to the ground. Angle the strimmer 30° to the right. Set the handle to the desired position (see fig. 6c).

Cutting against trees/fences/foundations (with strimmer)

NOTE

- The filament will wear or fray quickly if it comes into contact with trees, rocks, walls or foundations. The filament will break off if it strikes fence mesh.

⚠ CAUTION!

- Do not use the appliance to remove any objects from footpaths, etc.! The appliance is powerful and can fling small stones or other objects 15 metres or more and may cause injuries or damage to cars, houses and windows.



Wear protective goggles!

Seizing

Immediately turn off the engine if the cutting tool becomes blocked. Remove all grass and scrub from the appliance before restarting the appliance.

Prevent kickback

When working with the 3-section cutting blade there is a risk of kickback if the blade strikes against solid obstacles (tree trunks, branches, tree stumps, rocks or similar). This will result in the cutting tool being catapulted back against the direction of rotation. This can lead to the loss of control of the appliance. Do not use the cutting blade near fences, metal posts, boundary stones or foundations. To cut low-density shrubs, position the appliance as shown in fig. 6e to avoid kickbacks.

Working with the hedge trimmer

Cutting techniques

- The double-sided cutter bar allows cutting in both directions or by using swinging movements from one side to the other.
- For a vertical cut, move the hedge trimmer evenly forwards or up and down in an arc.
- For a horizontal cut, move the hedge trimmer in a scything motion along the edge of the hedge so that cut branches fall to the ground.
- See figure A.

NOTE

- ▶ Remove thicker branches with a branch cutter.

Working with the pole pruner

Sawing techniques

⚠ WARNING!

- ▶ Always pay attention to the falling clippings.
- ▶ Be aware of the danger of branches swinging back.

NOTE

- ▶ Place the stop ③ on the branch. This will help you work more safely and quietly.
- ▶ Now you can begin sawing.

Sawing off small branches

- ◆ Saw small branches (Ø 0-8 cm) from the top down (see figure).

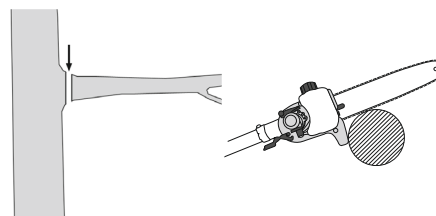

Sawing off larger branches

- ◆ When sawing larger branches (Ø 8-25 cm), first make a relief cut ① (see figure). A relief cut also prevents peeling of the bark on the main trunk.
- ◆ Saw from the top ② to the bottom ③.

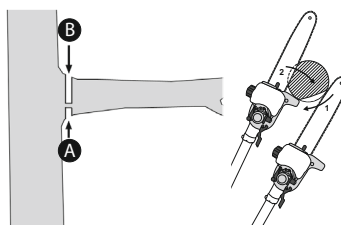

Saw in sections

Trim long or thick branches before you make the final cut (see figure).

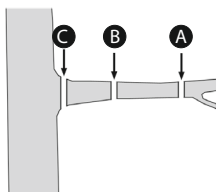

Working safely

- Keep the appliance, the cutting mechanism and the chain guard 60 in good condition to prevent injury.
- If the appliance has been dropped, check for significant damage or defects.
- Observe the specified working angle max. $60^\circ \pm 10^\circ$ to ensure safe working (see figure).

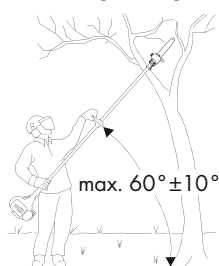

- Do not use the appliance while standing on a ladder or with unsteady footing.
- Do not be tempted into making a poorly considered cut. You could endanger yourself and others.
- Children should be supervised to ensure that they do not play with the appliance.
- Change your working position regularly. Using the appliance for a long time can lead to vibration-related circulation disorders of the hands. You can extend the usage duration by using appropriate gloves or by taking regular breaks. Note that any personal predisposition to poor blood circulation, low external temperatures or large gripping forces can reduce the usage period.

Transport

- Use the protective cases 59/60 for transporting the appliance.
- To prevent injuries, ensure that the appliance cannot switch on during transport (see figure).

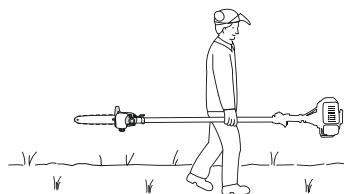

Cleaning

Cleaning the engine unit

NOTE

- Clean the appliance thoroughly after every use.
- Always switch off the appliance before cleaning and then disconnect the spark plug connector 10.
- Clean the appliance regularly with a damp cloth and a mild detergent. Make sure that no water can penetrate into the interior of the appliance.

Cleaning the pole pruner

- The pole pruner must be cleaned of sawdust at regular intervals.
- ◆ Remove the sprocket cover 38.
- ◆ Remove the saw chain 31 from the blade 30 and clean the guide rail 41.
- ◆ Keep the saw chain 31 sharp and check the tension; check the oil level and the oil supply.

Cleaning the hedge trimmer

- ◆ Check the hedge trimmer for loose screws on the cutter bar 20 and tighten these if necessary.
- ◆ Remove stuck cuttings.
- ◆ Maintain the cutter bar 20 using an oil spray or an oil can.

Cleaning the strimmer/cutting blade attachment

- ◆ Remove stuck cuttings.
- ◆ Keep the 3-section cutting blade 49 sharp to facilitate your work.

Maintenance

Replacing the strimmer/cutting filament

- 1.) The strimmer 50 must be removed as described in the section "Installing/replacing the strimmer". Press the marking (see fig. 5a) and remove the cover (see fig. 5b).
- 2.) Remove the spool bobbin 1 from the strimmer housing (see fig. 5c).
- 3.) Remove any remaining cutting filament.
- 4.) Double the new cutting filament and hook the loop that you have made into the recess on the spool bobbin (see fig. 5d).
- 5.) Wind the filament tightly in an anticlockwise direction. The spool bobbin 1 separates the two halves of the cutting filament (see fig. 5d).
- 6.) Now take the cover in your hand and place the spool bobbin 1 in it. Make sure that the filament holder of the spool bobbin lines up with the filament guide on the cover.
- 7.) Now release the cutting filament from the spool bobbin 1 and guide it through the metal eyes in the cover.
- 8.) Put the two halves of the housing back together so that they click into place.
- 9.) Cut any excess filament back to about 13 cm. This reduces the load on the engine when starting and warming up.
- 12.) Refit the strimmer (see section "Installing/replacing the strimmer").

Air filter maintenance

Contaminated air filters reduce the engine performance due to low air supply to the carburettor.

Regular inspection is essential. The air filter ① must be inspected after every 25 hours of operation and cleaned if necessary.

The air filter must be checked more frequently if the air is dusty.

- 1.) Remove the cover of the air filter housing ⑫.
- 2.) Remove the air filter ①.
- 3.) Clean the air filter ① by tapping or blowing it out (with compressed air).
- 4.) Assembly is done in the reverse order.

⚠ CAUTION!

- Never clean the air filter with petrol or flammable solvents.

Spark plug maintenance

- 1.) Pull off the spark plug connector ⑩.
- 2.) Remove the spark plug using the enclosed spark plug spanner ⑥⑤.
- 3.) Assembly is done in the reverse order.

Electrode gap = 0.6 mm (distance between the electrodes between which the ignition spark is generated). Check the spark plug for contamination after the first 10 hours of operation and clean it with a copper wire brush if required.

Afterwards, service the spark plug after every 50 hours of operation.

Grinding the protective guard blade

The blade ① (see fig. 2a) can become blunt over time. If you find this to be the case, undo the 2 screws that hold the blade ① onto the cutting filament protective guard ③. Clamp the blade ① in a vice. Grind the blade ① with a sharpening stone and make sure you maintain the angle of the cutting edge.

Adjusting the carburettor

Remove the cover of the air filter housing ⑫.

Adjusting the throttle cable

If the appliance no longer reaches maximum speed after a while and all other causes as described in the "Troubleshooting" section have been ruled out, this may mean that the throttle cable needs to be adjusted. To adjust the throttle cable, screw in the screw ④ or the adjusting screw ④ as well as the lock nut ⑤ correctly (see Fig. 4).

Lubricating the gears

- Add liquid gear grease after every 20 hours of operation (approx. 10 g) to lubricate the angle gear.
- ◆ To do this, undo the screw ① to press the gear grease into the gear housing.
- ◆ After filling the gearbox, close the lubrication hole with the screw ①.

Storage and transportation

- Store the appliance in a safe location.
- Store the appliance and accessories in a safe location which is protected against naked flames and sources of heat/sparks, such as gas-powered water heaters, dryers, oil stoves or mobile heaters, etc.
- Ensure that the protective guard ④③, the trimmer ⑤① and the engine are free of cutting residue when storing.
- The plastic cover for the 3-section cutting blade ④⑤ must be refitted for transport and storage.
- Always turn the appliance off before performing any maintenance work and remove the spark plug connector ⑩.

Storing the appliance

The appliance must be prepared for storage if it is to be stored for longer than 30 days. Otherwise the residual fuel in the carburettor will evaporate and leave a goeey sediment. This may make starting the appliance more difficult and result in expensive repair work.

- 1.) Remove the filler cap ⑭ to relieve any pressure in the fuel tank ⑬. Carefully empty the fuel tank ⑬.
- 2.) To remove all fuel from the carburettor, start the engine and leave it to run until it stops.
- 3.) Allow the engine to cool for about 10 minutes.
- 4.) Remove the spark plug (see section "*Spark plug maintenance*").
- 5.) Add 1 teaspoon of 2-stroke oil to the combustion chamber. Pull the starter pull cord ⑫ several times to wet all mechanical parts with oil. Replace the spark plug.

NOTE

- Store the appliance in a dry place and away from possible ignition sources.

Start-up after storage

- 1.) Remove the spark plug (see section "*Spark plug maintenance*").
- 2.) Pull the starter pull cord ⑫ quickly in order to remove any excess oil from the combustion chamber.
- 3.) Clean the spark plug and observe the correct electrode gap on the spark plug.
- 4.) Fill the fuel tank ⑬. See the section "*Fuel and oil*".

Transport

- If you are planning to transport the appliance, empty the fuel tank ⑬ as explained in the section "*Storage*".

Troubleshooting

Engine unit

Problem	Possible cause	Troubleshooting
The engine does not start.	Incorrect start-up process.	Follow the instructions regarding starting.
The engine starts but does not run at full power.	Incorrect adjustment of the choke lever ①.	Set the choke lever ① to "I + ".
	Contaminated air filter.	Clean air filter.
The engine does not run smoothly.	Incorrect spark plug gap.	Clean the spark plug and adjust the spark plug gap or replace the spark plug.
Soot deposits or wetness on the spark plug.	Incorrect carburettor adjustment.	Clean spark plug or replace it with a new spark plug.

Pole pruner

Problem	Possible cause	Troubleshooting
Motor is running, saw chain ③① does not move.	Hedge trimmer attachment or pole pruner attachment is not connected properly to the engine unit.	Check assembly.
No progress.	Saw chain ③① dry/overheating or is sagging.	Top up the oil or reground, replace or tighten the saw chain ③①.

Hedge trimmer

Problem	Possible cause	Troubleshooting
Motor is running, blades do not move.	Hedge trimmer attachment or pole pruner attachment is not connected properly to the engine unit.	Check assembly.

Maintenance intervals

Pole pruner

The figures given here are based on normal operating conditions. In the event of more difficult conditions, such as strong dust generation and longer daily operating hours, the given intervals are to be reduced correspondingly.

Appliance part	Action	Before starting work	Weekly	In the event of faults	In the event of damage	As required
Lubricating the chain	Check	X				
Check saw chain ③①	and pay attention to the sharpness	X				
	Check chain tension	X				
	sharpen					X
Check guide rail ④①	(wear, damage)	X				
	clean and turn		X	X		
	deburr		X			
	replace				X	X
Check sprocket ④②			X			
	replace					X

Hedge trimmer

The figures given here are based on normal operating conditions. In the event of more difficult conditions, such as strong dust generation and longer daily operating hours, the given intervals are to be reduced correspondingly.

Appliance part	Action	Before starting work	After completion of work	As required
Cutting blade	Visual inspection	X		
	Cleaning		X	X

Ordering spare parts

Ordering spare parts

Only use original spare parts: The use of non-original and/or incorrectly fitted parts will jeopardize the safety of the machine, may cause accidents or personal injuries which the manufacturer is under no circumstance liable or responsible.

HYUNDAI
POWER PRODUCTS