



# CAST IRON COUNTRY COOKER

Model No. CS2134 / CS2145

Made from high quality cast iron and angle iron with brass controls

A stable surface and fine controls make cooking easy

High temperature surface coating

Outlet 3/8" SAE

Hose and regulator included

Propane / ULPG use only

Gas certified to Australian Standards

For outdoor use only



CS2134



CS2145



**NOTE: ONLY USE ON A NON-COMBUSTIBLE SURFACE**

Gasmate® is a registered trademark of  
Sitro Group Australia Pty Ltd [www.gasmate.com.au](http://www.gasmate.com.au)  
Aber Living, N.Z [www.gasmate.co.nz](http://www.gasmate.co.nz)

**Important: Retain these instructions for future use**

# GENERAL WARNINGS

## WARNING

- **Read these instructions for use carefully. Familiarise yourself with the appliance before connecting it to its gas container. Keep these instructions for future reference.**
- This appliance shall only be connected to a Propane/ULP gas cylinder with a POL/QCC cylinder valve certified to AS2469 standards.
- It maybe hazardous to attempt to fit other types of gas containers or cartridges.
- This appliance shall only be used with the Hose and Regulator Assembly supplied, Regulator is set to 95kPa and is not adjustable – Do Not Modify.
- This appliance is designed for outdoor use only and must be operated away from any flammable material or surfaces and materials.
- This appliance is to be stored in a dry and well-ventilated location free from direct sunlight.
- Do not store when appliance is still connected to the cylinder.
- Make sure that the cylinder is disconnected and is stored in a well-ventilated area, free from direct sunlight, heat and ignition sources.
- If being stored indoors, ensure that the location complies with the standard AS/NZS1596.
- This appliance must only be serviced by an authorised service agent, contact SITRO Group for assistance with repairs and spare parts.

## DANGER

- During operation all surfaces will be extremely hot and should not be touched or handled.
- Do not use the appliance if it is leaking, damaged or does not operate properly.
- This appliance must only be serviced by an authorized person.
- Handle with care even after brief use, always pick up using the body not the cylinder.
- It may be hazardous to attempt to fit other types of gas containers or cartridges.
- Use only in well ventilated areas.
- Always operate appliance a minimum of 500mm from flammable materials, walls and 1200mm from the ceiling.
- Do not modify appliance to fit other connectors or cylinders.
- Only use the hose assembly as supplied with this appliance for connection to the cylinder – DO NOT USE ADAPTORS.
- Avoid twisting or kinking the flexible hose.
- Do not modify this appliance.
- Do not use multiple appliances to heat a single utensil.
- Children must be supervised by an adult at all times.
- Never leave appliance unattended when operating.
- Use as a cooking appliance only, not to be used as heater or modified for any other reason.
- Avoid boil over and spills on to burners.

## CARBON MONOXIDE HAZARD

Using this appliance in an enclosed space may cause DEATH. Do not use in caravans, tents, marine craft, cars, mobile homes or similar locations.

ONLY USE IN WELL VENTILATED AREAS



## IMPORTANT

- Use outdoors only.
- Keep children away at all times.
- CAUTION: Accessible parts may be very hot. Please take care when handling or moving the appliance.
- Appliance is to be used on a stable, level, flat, non-flammable surface. The appliance should be protected from direct drafts and in a well ventilated place.
- Only cooking vessels with a minimum diameter of 200mm and a maximum of 300mm are to be used with this appliance.
- This appliance shall only be used in an above ground open air situation with natural ventilation, without stagnant areas, where gas leakage and products of combustion are rapidly dispersed by wind and natural convection.
- Take care that the primary air intakes, located on the burner tube of this appliance are not obstructed, or that air flow is restricted by placing items or other appliances close to or adjacent to the inlets.
- If there is a leak on your appliance (smell of gas), immediately attempt to turn off the cylinder valve. Remove the appliance to a well-ventilated location away from any ignition source. Check for leaks using soapy water. Do not try to detect leaks using a flame.
- Do not attempt to move or relocate the appliance when it is operating, extinguish the burner and allow to cool, disengage the gas cylinder then move the appliance.

## CHECKING FOR GAS LEAKS

- Check that all connections are tight and that the gas cylinder connection has been tightened before you turn the cylinder gas valve on.
- NEVER check for leaks with a flame or pilot light.
- Using Gas Leak Detection Spray or soapy water, coat all connections, if bubbles appear turn the cylinder gas control off and retighten the connection before re-testing.
- Inspect the appliance regularly for signs of wear, leaks or incorrect operation.

If symptoms such as flaring of the burner, issues with lighting, damages to hoses or connections or leaks from seals or gas controls are identified do not attempt to repair, return to your authorised stockist for service and maintenance.

## CHANGING GAS CYLINDER

- To check if gas remains in the cylinder, disconnect from the appliance and hold the cylinder in a vertical position then shake from side to side, if there is a sound or feel of liquid movement inside, the cylinder contains gas.
- When changing gas cylinders ensure this is conducted outside in a well-ventilated location free from people, animals and ignition sources such as naked flames, pilot lights and electrical equipment with heaters or elements.

# GENERAL INFORMATION

## GAS INSTALLATION CODES

- Appliance must be used in accordance with the installation requirements of your gas supply authority, or the appropriate installation code issued by Standards Australia AS 5601.
- Appliances for use with bottled gas are labelled 'propane gas'.
- Only use on a non-combustible surface.

## CLEARANCES

Minimum Clearances from combustible materials must be:

Cylinder - 500mm

Wall - 500mm

Above - 1200mm

Below - never use on a flammable surface.

Only use on a non-combustible surface.

**Gas connection is 1/4" BSP**

## HOSE & REGULATOR SAFETY

The regulator and hose assembly supplied with the appliance are suitable for propane gas only.

The pressure regulator and hose assembly supplied with the appliance must be used. Replacement pressure regulators and hose assemblies must be those specified by the appliance manufacturer.

Only use the hose assembly supplied with this appliance for direct connection to the cylinder

**"DO NOT USE ADAPTORS". Check the regulator "O" Ring periodically for wear or damage and replace if required.**

When connecting the hose and regulator assembly to the gas cylinder, take care to avoid unnecessary twisting or kinking of the flexible hose. Maximum hose length is 1 metre.

After the assembly has been secured, turn on the gas and check for leaks by brushing a soap and water solution overall connections.

DO NOT USE this appliance if it is leaking, damaged or does not operate properly.

If you are unable to correct the leak by tightening the connections, turn off the gas and contact the supplier immediately.

Always ensure the appliance is kept away from flammable materials and the gas cylinder clear of any heat source. When changing over from an empty gas cylinder to a full one make sure this procedure is carried out in a well ventilated location, preferably outside, away from people and away from any sources of ignition; such as naked flames, pilot flames, electric heaters/equipment.

## SPECIFICATIONS

Appliance specifications can be found on the data label attached to the appliance body.

## GAS CYLINDER USE & SAFETY

This is a low pressure appliance and must only be used with the hose and regulator supplied. This appliance shall only be used with propane gas cylinders certified to AS 2469. It may be hazardous to attempt to fit other types of gas containers.

The gas cylinder should be filled by a reputable gas supplier and visually inspected and re-qualified at each filling.

Always keep cylinder in an upright position. Always close the cylinder valve when the appliance is not in use. Do not subject gas cylinder to excessive heat.

## GAS INSTALLATION CODES

- Appliance must be used in accordance with the installation requirements of your gas supply authority, or the appropriate installation code issued by Standards Australia AS 5601.
- Appliances for use with bottled gas are labelled 'propane gas'.
- Only use on a non-combustible surface.

## NEVER STORE YOUR GAS CYLINDER INDOORS

If you store your appliance indoors, ALWAYS disconnect the gas cylinder first and store the cylinder safely outside. Cylinders must be stored outdoors in a well ventilated area out of reach of children, and must not be stored in a building, garage or any other enclosed area.

## LOCATION OF YOUR APPLIANCE

Only use on a non-combustible surface. DO NOT use your appliance in garages, porches, sheds, breezeways, or other enclosed areas. Your appliance is to be used OUTDOORS ONLY. The appliance is not intended to be installed in or on recreational vehicles and/or boats and should not be placed on any surface that will burn. Do not obstruct the flow of combustion and ventilation air around the appliance.

## PROTECT CHILDREN

Keep children away from appliance during use and until appliance has cooled after you have finished. Do not allow children to operate appliance.

Always ensure that no sporting or physical activities are carried out in close proximity to the appliance during use and while still hot.



## TOOLS YOU WILL NEED

Adjustable spanner, phillips screwdriver.

## CHECK APPLIANCE FOR ANY DAMAGE

Inspect appliance parts as you proceed. Contact your supplier for assistance regarding replacement of any damaged or missing parts. Do not assemble or operate a appliance that appears damaged. Appliance for use with gas cylinders are labelled 'propane gas'. Check labelling at the gas connection on your appliance.

## PRODUCT DETAILS

	<b>CS2134 Cast Iron Single Burner Country Cooker</b>	<b>CS2145 Cast Iron Double Burner Country Cooker</b>
<b>Gas Type</b>	Propane / ULPG	
<b>Injector Size</b>	Propane: $\varnothing$ 1.00 ULPG: $\varnothing$ 1.00	
<b>Gas Consumption</b>	13MJ/h 258g/h	26MJ/h 516g/h
<b>Gas Pressure</b>	2.80kPa	
<b>Gas Inlet</b>	3/8"SAE	
<b>Certificate</b>	SAI - 400380  Gas Safety Certified	 AUSTRALIA AND NEW ZEALAND GAS SAFETY CERTIFICATION

## CARE & MAINTENANCE

During operation if it is noted that the burner flame is unstable, is changing colour from blue to yellow or has a distinct smell it is important that you contact SITRO Group for your local authorised gas appliance repairer for inspection. Periodically check the gas control is tight and has no leaks, follow the testing for leaks procedure. Check the gas connection and regulator for any signs of wear or damage, if identified contact customer service for a replacement assembly immediately.

For further information or assistance please contact Customer Service on 1300 174 876 between the hours of Monday to Friday 8.00am – 5.00pm EST or email [service@sitro.com.au](mailto:service@sitro.com.au)

## TROUBLE SHOOTING

<b>Problem</b>	<b>Possible Reason</b>	<b>Solution</b>
<b>Burner will not ignite</b>	Valve on gas bottle closed	Open valve on gas bottle
	Control knob is closed	Turn knob onto high when lighting
<b>Food is not cooking or is taking too long</b>	Burner has gone out	Check that the gas bottle is not empty and re-ignite burner
	Primary air disc is open to far	Wind closer to burner tube

# PARTS LIST

## SINGLE BURNER



Corner Trivets  
x 4



Frame & Burner  
x 1



Legs  
x 4



Mounting Screws  
x 16



Gas Valve  
with Primary Air Disc x 1  
Screws x 2

## DOUBLE BURNER



Corner Trivets  
x 4

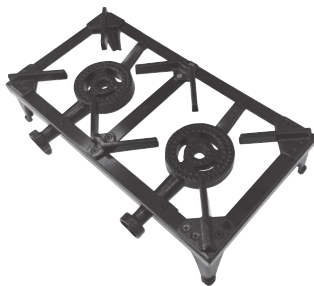

Frame & Burner  
x 1



Legs  
x 4



Mounting Screws  
x 16



Centre Trivets x 2  
Screw & Nut Assembly x 2



Gas Valve with Primary Air  
Disc & Manifold x 1  
Screws x 4

Note: Remove any transit protection material before using the burner.

## ASSEMBLY

Review the contents of the package. Make sure all listed components are included.

1. To attach centre trivet (PIC. 1) use supplied screw and nut assembly. Attach legs and corner trivets to frame using supplied screws, taking care to align the internal thread in leg assembly (PIC. 2).
2. Align the gas control assembly at the end of the burner tube and then secure with screws (PIC. 3).
3. Ensure that Primary Air Disc is located close to the burner tube opening. Attach the LP Gas hose to the Gas Valve Assembly using a spanner – Do Not Over Tighten.

**PIC. 1**

**Centre Trivet (Twin Burner Only)**

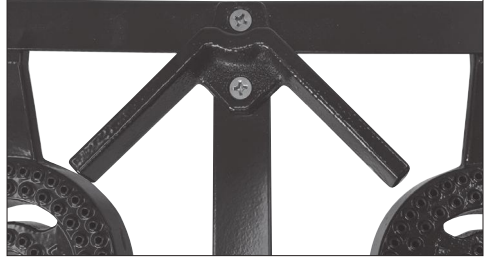

**PIC. 2**

**Corner Trivets**



**PIC. 3**

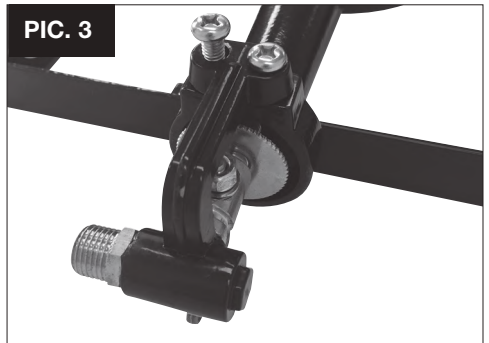

### IMPORTANT

- Do not smoke when attempting to ignite appliance.
- Always use protective gloves when handling hot components.
- Do not smoke at any time when attempting to ignite the appliance burners.

**Caution:** Do not move the appliance while in operation.

- Do not leave the appliance unattended when alight.

Before connecting and disconnecting appliance to gas source, make sure burner controls are in 'OFF' position.



CLOSE TO THE BURNER TUBE OPENING

## GENERAL ASSEMBLY

### CONNECTING & DISCONNECTING TO GAS SOURCE

Familiarise yourself with the general information and safety guidelines located at the front of this manual.

#### CONNECTION

1. Gas cylinder is filled. A sloshing sound will be heard when shaken.
2. Connect the Regulator to the cylinder valve and tighten (PIC. 4).
3. Check for any damage to either the cylinder connection or the hose. NEVER attempt to use damaged equipment.
4. Turn the gas cylinder valve on and spray soapy water on all connections to check for leaks. If a leak is detected turn the valve off, retighten all connections and retest (PIC. 5).

#### GENERAL POSITIONING

1. Never place or position the cooker on combustible material. Only use on a non-combustible surface.
2. Ensure the gas hose is straight and not kinked.

## LIGHTING THE COOKER

### ADJUSTING HEAT OUTPUT

1. Turn the gas control in a clockwise direction to achieve a higher flame and in the anti-clockwise direction for a lower flame or to turn off (PIC. 6 & 7).

Note: Locate the gas cylinder away from your cooker to ensure it is not subjected to radiant heat.

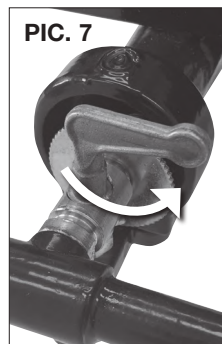
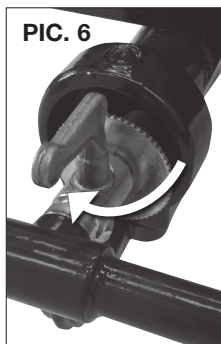
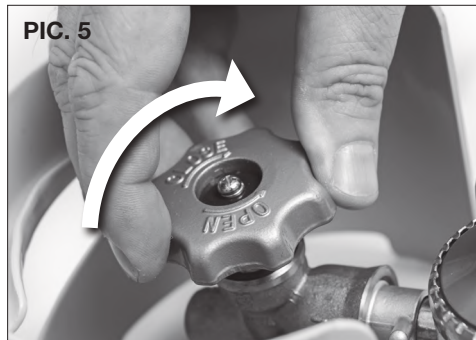

## TURNING THE APPLIANCE OFF

If the appliance is no longer to be used and to reduce the risk of blocked gas jets caused by excess gas being left in the hose, all remaining gas must be expelled from the hose assembly.

1. With the flame still operating, turn the valve on the gas cylinder in the anti-clockwise direction until it is off. Allow the flame to burn down then extinguish once all remaining gas in the hose has been used (PIC. 8).
2. Turn the gas controls on the appliance clockwise to the "OFF" position (PIC. 9).

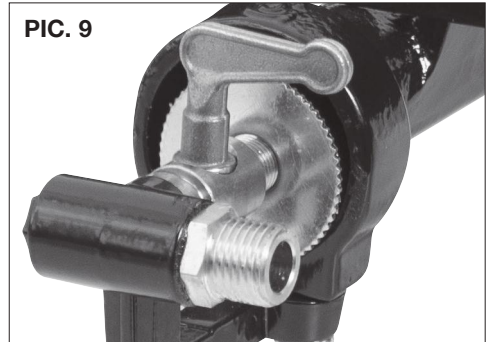
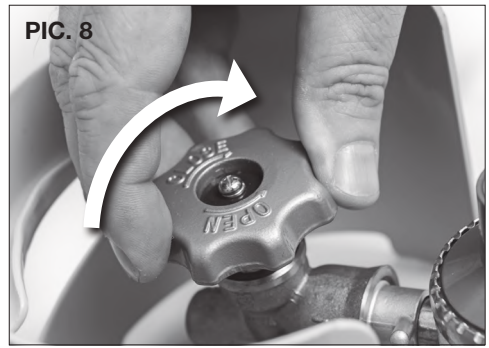

### IMPORTANT

**CAUTION:** When the appliance is not in use, the gas must be turned off at the cylinder.

Check that the seals between the appliance and the gas cylinder are in place and in good condition before connecting the gas cylinder.

Do not use this appliance if it has damaged or worn seals.

- Beware of spiders and wasps. Burner tube should be inspected and cleaned periodically.
- This appliance must only be serviced by an authorised person.

**NOTE: ONLY USE ON A NON-COMBUSTIBLE SURFACE**

## SAFE APPLIANCE LOCATIONS

This appliance shall only be used in an above ground open-air situation with natural ventilation, without stagnant areas, where gas leakage and products of combustion are rapidly dispersed by wind and natural convection.

**Only use on a Non-combustible surface.**

**Any enclosure in which the appliance is used shall comply with the following:**

An enclosure with walls on all sides, but at least one permanent opening at ground level and no overhead cover.

Within a partial enclosure that includes an overhead cover and no more than two walls.

**Within a partial enclosure that includes an overhead cover and more than two walls, the following will apply:**

at least 25% of the total wall area is completely open, and

at least 30% of the remaining wall area is open and unrestricted.

**In the case of balconies, at least 20% of the total wall area shall be and remain open and unrestricted.**

## DIAGRAMMATIC REPRESENTATIONS OF OUTDOOR AREAS

The following figures are diagrammatic representations of outdoor areas. Rectangular areas have been used in these figures – the same principles apply to any other shaped area.

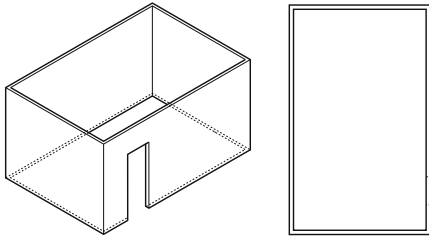

**Outdoor Area - Example 1**

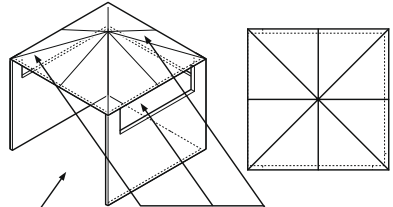

Open Side at least 25% of total wall area

30% or more in total of the remaining wall area is open and unrestricted

**Outdoor Area - Example 4**

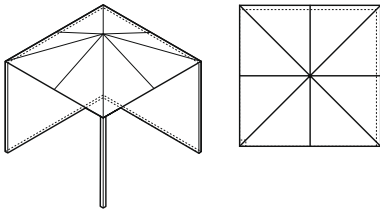

**Outdoor Area - Example 2**

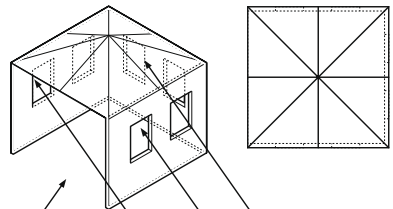

Open Side at least 25% of total wall area

30% or more in total of the remaining wall area is open and unrestricted

**Outdoor Area - Example 5**

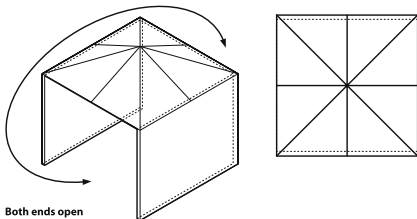

Both ends open

**Outdoor Area - Example 3**

