

**CROMTECH**  **OUTBACK** <sup>4.5i</sup>

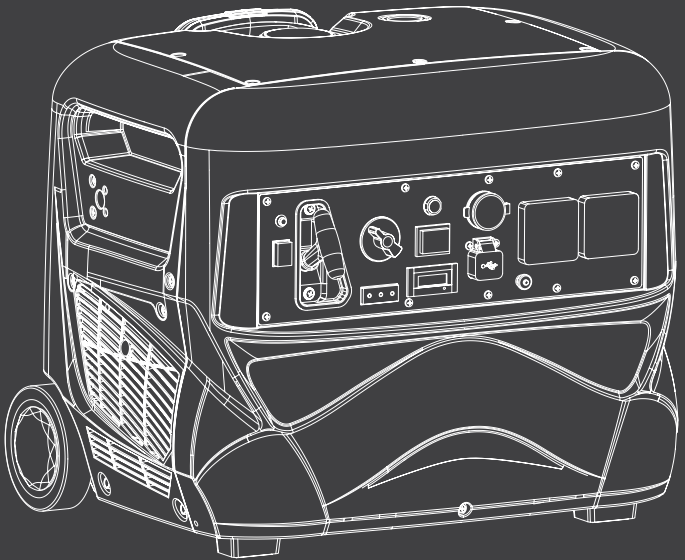

**CROMTECH OUTBACK 4.5i  
OPERATION MANUAL**

Thank you for purchasing your Cromtech Generator.

This manual provides understanding of the operation and maintenance of your generator. Please read this manual carefully before operating.

For any questions regarding operation or maintenance, please consult your local service agent. Find your local service agent at [www.crommelins.com.au](http://www.crommelins.com.au).

### IMPORTANT ICONS

Important information is distinguished by the notifications below. The Safety Alarm Symbol () alerts you to potential hazards. Please obey all safety information in the symbol to avoid any possible injury or even death.

 **DANGER:** - Indicates a hazardous situation which, if not strictly complied with, will result in substantial property damage, serious injury or DEATH.

 **WARNING:** Indicates a hazardous situation which, if not strictly complied with, may result in property damage.

 **CAUTION:** Indicates a hazardous situation which, if not strictly complied with, could result in property damage or injury.

 **NOTE:** Indicates important information to simplify operation and understanding.

 **WARNING: PLEASE READ AND UNDERSTAND THIS MANUAL BEFORE OPERATING THE GENERATOR.**

 **NOTE: We continually seek advancements in product design and quality. Therefore, there may be minor discrepancies in actual machine and the printed manual.**

## INDEX:

<b>Warranty</b> .....	<b>5</b>
Consumer Advice .....	5
Contact Details .....	5
<b>Location of Important Labels</b> .....	<b>6</b>
Symbol Meanings .....	8
<b>Safety Information</b> .....	<b>9</b>
Poisonous Exhaust .....	9
Highly Flammable and Poisonous Fuel .....	10
Operation or Moving .....	10
Hot Engine and Muffler .....	10
Electric Shock Prevention .....	11
<b>CTG4500iE Diagram</b> .....	<b>12</b>
Control Panel .....	12
Fuel Switch .....	13
Engine Switch .....	13
Engine Start Button .....	13
Remote Control .....	13
Eco Switch .....	13
AC Outlet .....	13
LED Indicators .....	13
Low Oil Alarm (Yellow) .....	14
Overload Alarm and Reset Button (Red) .....	14
Output Indicator (Green) .....	15
<b>Pre-Operation Check</b> .....	<b>16</b>
Fuel & Tank Capacity .....	16
Engine Oil .....	17
Recommend Engine Oil .....	17
Engine Oil Capacity .....	17
Ground (Earth) Terminal .....	18
Multi-function power pack (Battery) .....	18
Connect multi-function power pack .....	18
<b>Operation Instructions</b> .....	<b>19</b>
Starting the Generator .....	20
Electric Start .....	20
Remote Start .....	20
Recoil Start .....	20

<b>Application Range</b> .....	<b>22</b>
AC Connection (Powering Equipment) .....	22
Starting the Generator .....	23
DC Connection (Battery Charging) .....	24
Stopping the Generator .....	25
<b>Periodic Maintenance</b> .....	<b>26</b>
Maintenance Chart .....	26
Spark Plug Inspection .....	28
Air Filter Inspection .....	28
Oil Replacement .....	30
Spark Arrestor Element .....	31
Fuel Tank Filter .....	32
<b>Troubleshooting</b> .....	<b>32</b>
<b>Storage</b> .....	<b>34</b>
Transport .....	34
<b>Identification &amp; Serial Numbers</b> .....	<b>35</b>
<b>Wiring Diagram</b> .....	<b>36</b>
<b>CTG4500iE Specifications</b> .....	<b>38</b>
Features .....	39
Applications .....	39
Accessories .....	39

## **WARRANTY**

CROMTECH™ and CROMMELINS™ are a registered trademark of Crommelins Machinery. Crommelins Machinery warrants their goods against defects in materials and workmanship under normal use and service.

The warranty does not cover fair wear commensurate with the age of the product, any damage caused by accident, abuse, misuse, neglect or failure to observe proper operating instructions or proper machinery maintenance as described in the instruction manual.

It is the owner's responsibility to regularly maintain a product in accordance with the owner's manual and only use the equipment for its designed purpose.

Our goods come with guarantees that cannot be excluded under the Australian Consumer Law. You are entitled to a replacement or refund for a major failure and for compensation for any other reasonably foreseeable loss or damage. You are also entitled to have goods repaired or replaced if the goods fail to be of acceptable quality and the failure does not amount to a major failure.

## **CONSUMER ADVICE**

Any claim under these warranties must be made in the warranty period from the date of purchase of the product.

There are over 185 national authorised service/repair agents available, visit [www.crommelins.com.au](http://www.crommelins.com.au) for their details and locations.

To make a claim under the warranty, you must return the product (with proof of purchase) to the closest warranty agent or to the place of purchase.

Where a failure does not amount to a major failure, Crommelins Machinery is entitled to choose between providing you with a repair, replacement or refund. To obtain compensation, you would need to provide documentary evidence of the loss or damage suffered, and documentary evidence that such loss or damage was a reasonably foreseeable consequence of a failure by Crommelins Machinery to comply with a consumer guarantee under the Australian Consumer Law.

Crommelins Operations Pty Ltd trading as Crommelins Machinery, The Crommelin Group and Crommelins Australia.

## **CROMMELINS MACHINERY**

Ph: 1300 650 659

[reception@crommelins.com.au](mailto:reception@crommelins.com.au)

[www.crommelins.com.au](http://www.crommelins.com.au)

PO Box 352, BENTLEY WA 6982

ABN 11 008 889 656

## LOCATION OF IMPORTANT LABELS

**!** NOTE: Maintain/replace safety and instruction labels, if worn or illegible when necessary.



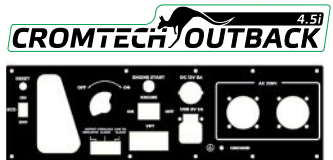

- ① Main logo placement/s
- ② Control panel
- ③ Inverter generator
- ④ Model number
- ⑤ Spark plug information
- ⑥ Oil fill and type
- ⑦ Emission control information
- ⑧ Unleaded fuel only
- ⑨ Never operate indoors warning
- ⑩ Operation instructions warning
- ⑪ Name plate and serial number
- ⑫ Warning hot surfaces
- ⑬ Connect power pack
- ⑭ No oil in engine



### INVERTER GENERATOR CTG450iE

EMISSION CONTROL INFORMATION	
ZHEJIANG EVERLAST POWER CO., LTD.(ELP) <input checked="" type="checkbox"/>	
FAMILY NAME: KZEPS2121EL	
EMISSION CONTROL SYSTEM: EM	
ENGINE DISPLACEMENT: 211.5cc	
OIL: SAE15W-40 BUILD DATE: 09/2019	
THIS ENGINE MEETS U.S. EPA EXH REGS FOR 2019.	
THIS ENGINE IS CERTIFIED TO OPERATE ON UNLEADED GASOLINE.	
EMISSION COMPLIANCE PERIOD: 125 HOURS	
SEE OWNER'S MANUAL FOR MAINTENANCE SCHEDULE.	
WARNING: READ OWNER'S MANUAL BEFORE OPERATION.	
<hr/>	
ZHEJIANG EVERLAST POWER CO., LTD. (ELP) <input checked="" type="checkbox"/>	
DATE OF MANUFACTURE: 09/2019	
FAMILY NAME: KZEPNHEQEE	
THIS ENGINE MEETS U.S. EPA EVAP STANDARDS FOR 2019.	
SEE OWNER'S MANUAL FOR MAINTENANCE SCHEDULE.	
WARNING: READ OWNER'S MANUAL BEFORE OPERATION.	

# UNLEADED FUEL ONLY

<b>CROMTECH OUTBACK</b>   		
Model No.: CTG4500IE	IP Grade: IP23	Max. Speed: 3600rpm
Max. Output: 4500W	Phase: Single Phase	Net Weight: 38kg
Rated Output: 3700W	Engine: 6hp Cromtech LH170F	
Rated Voltage: 230V / 50HZ	Fuel Type: Petrol unleaded	
DC Voltage: 12V / 8 Amp	Serial Number:	
USB Outlet: 5V / 2 Amp	Production Date:	
Power Factor: 1.0		
Made in China		
Crommelins Operations Pty Ltd - 139 Welshpool Road, Welshpool WA 6106, Australia		

**⚠ DANGER ⚠**

Using a generator indoors **CAN KILL YOU IN MINUTES**. Generator exhaust contains carbon monoxide. This is a poison you cannot see or smell.



**NEVER** use inside a home or garage **EVEN** if doors and windows are open.







**ONLY USE OUTSIDE** and far away from windows, doors and vents.

CROMMELINS MACHINERY To avoid generator hazards READ MANUAL BEFORE USE.

**⚠ WARNING**

**↓ HOT SURFACES**



**For safety, read carefully the owners manual before operating this equipment:**

- DO NOT operate this equipment in poorly ventilated areas.
- DO NOT direct exhaust fumes toward people, buildings or equipment.
- When refueling, always stop the engine.
- Always immediately wipe up the fuel that is spilled.
- Keep any flammable items away from this equipment.
- Use gasoline 92 octane or above and refill oil as required to ensure equipment performance.
- DO NOT expose the equipment directly to rain or snow.
- DO NOT touch or contact the wiring sockets with wet hands.
- DO NOT connect the AC output to any indoor wiring.
- When operating the equipment, DO NOT put any barrier or obstacle around the equipment, or anything on top of the equipment. DO NOT cover the equipment with a box or the like.



**OIL**

UPPER LIMIT

LOWER LIMIT

SAE15W-40

**⚠ NOTICE**

- Stop the engine before refueling and clean up any spilled fuel.
- Use the specified spark plug only.

F7RTC TORCH | BPR7ES NGK



**⚠ NOTICE ⚠**

**CONNECT POWER PACK**

Remove cover to access multi-function power pack. See manual for installation.



**⚠ NOTICE**

**NO OIL IN ENGINE**

Fill the engine with oil to the correct level before starting the engine.

## SYMBOL MEANINGS

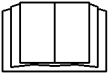
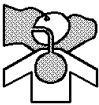



(Refer to SAFETY INFORMATION for more details. Page 8)

	Attention! Be alert! Your safety is important!
	Read the manual before operation.
	Be careful of poisonous exhaust.
	Never operate the machine in a closed area.
	Avoid touching hot surfaces, such as engine and muffler.

**!** **WARNING:** Inspect all appliances for damage before using on generator. If damaged - do not use the appliance.

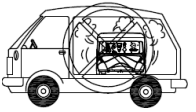

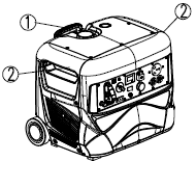
## SAFETY INFORMATION

<p><b>DO NOT</b> use in a closed vehicle. This generator is not designed for marine-use.</p>	
<p><b>DO NOT</b> modify or use the generator with any component removed.</p>	
<p><b>DO NOT</b> allow children to operate the generator.</p>	
<p>Make sure to move the generator only by its telescope handle or the lifting handles.</p> <p>① Telescope handle ② Lifting handles</p>	
<p>Do not place any obstacle on the generator.</p> <p>Do not place any obstacle in front of exhaust pipe</p>	
<p>Do not operate generator on wet or dusty/sandy surface. Operate on hard, dry surfaces only.</p>	

## POISONOUS EXHAUST

<p>Never operate generator in a closed area, as it may cause unconsciousness or death. Generator exhaust is carbon monoxide. This is a poisonous gas that you cannot see or smell.</p>	
<p>Operate the generator in a well-ventilated area.</p>	

## HIGHLY FLAMMABLE AND POISONOUS FUEL

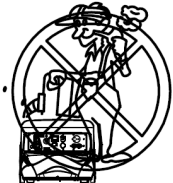

<p>Always stop the engine when refueling.</p> <p>Do not operate, refuel, or store generator near any source of ignition, including fire, heater, grinding sparks etc.</p>	
<p>Never refuel when smoking or near an open flame.</p> <p>Be careful not to spill any fuel on the engine or muffler when refueling.</p>	
<p>Do not swallow, inhale fuel vapor, or allow any fuel into your eye. If this occurs, seek medical attention immediately.</p> <p>If you spill fuel on your skin or clothing, wash it immediately with soap and water.</p>	

## OPERATION OR MOVING

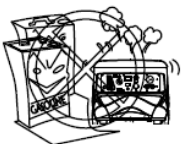

<p>When carrying the generator, keep the machine vertical (upright). Tilting may cause fuel leakage from carburetor or fuel tank. It may also cause oil overflow and block air filter element. Refer to troubleshooting if problem occurs.</p>	
<p>During transportation, ensure fuel tank cap is tightly on.</p>	

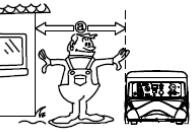
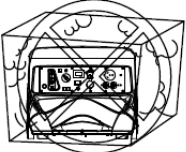
## HOT ENGINE AND MUFFLER

<p>Place the generator in a place where pedestrians or children can not reach.</p>	
<p>During operation, avoid placing any flammable material near the exhaust outlet.</p>	

<p>Keep the generator at least 1 metre distance from buildings or other equipment, if not, the generator may overheat.</p>	
<p>Do not operate the generator in a confined space or when covered with dust cover (or other materials).</p>	
<p>Ensure the engine and muffler are completely cooled, before covering generator.</p>	

## ELECTRIC SHOCK PREVENTION

<p>Never operate generator in rain or snow to avoid electric shock.</p>	
<p>Never touch the generator with wet hands, or electric shock may occur.</p>	

## CONNECTION TO A BUILDINGS ELECTRICAL SYSTEM

**⚠ WARNING:** Connection of a generator set to a buildings electrical system must be performed by a qualified and licensed electrician, and must apply with all applicable laws and all Australian electrical standards.

Incorrect connections to a buildings electrical system can allow for electrical current feedback into power utility lines. This feedback may electrocute the power utility worker or others who come into contact with the power-lines during a power outage. The generator may explode, burn, or cause fires when the power is restored.

## CTG4500iE DIAGRAM

- ① Top housing
- ② Air inlet cover
- ③ Handlebar 1
- ④ Multi-function power pack cover
- ⑤ Wheel
- ⑥ Left housing
- ⑦ Control panel
- ⑧ Recoil starter bar
- ⑨ N/A
- ⑩ Telescope handle
- ⑪ Fuel tank cap
- ⑫ Fuel gauge window
- ⑬ Right plate housing
- ⑭ Handlebar 2
- ⑮ Muffler exhaust outlet
- ⑯ Bottom plate
- ⑰ Maintenance cover
- ⑱ Air inlet port, air filter
- ⑲ Multi-function power pack
- (See page 18)
- ⑳ Multi-functional power pack cover

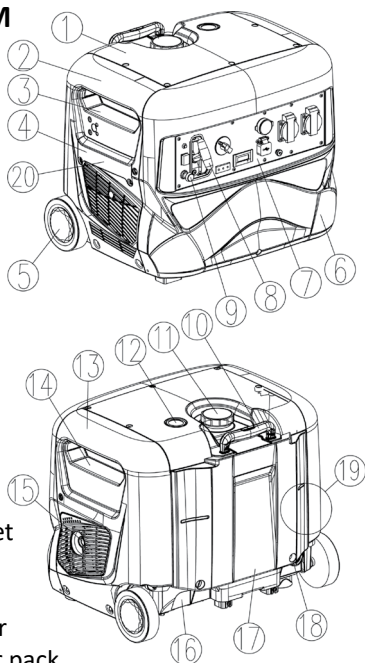

## CONTROL PANEL

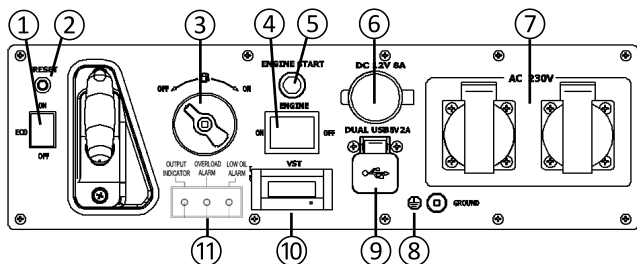

- |                                                                                                                                                                                     |                                                                                                                                                                                                                                                                                                                                                |
|-------------------------------------------------------------------------------------------------------------------------------------------------------------------------------------|------------------------------------------------------------------------------------------------------------------------------------------------------------------------------------------------------------------------------------------------------------------------------------------------------------------------------------------------|
| <ol style="list-style-type: none"> <li>① ECO switch</li> <li>② Reset button</li> <li>③ Fuel switch</li> <li>④ Engine switch</li> <li>⑤ Engine start</li> <li>⑥ DC Outlet</li> </ol> | <ol style="list-style-type: none"> <li>⑦ AC Outlets</li> <li>⑧ Ground terminal</li> <li>⑨ USB Outlets</li> <li>⑩ Volts / Frequency / Hrs</li> <li>⑪ LED Indicators                     <ul style="list-style-type: none"> <li>- Output indicator</li> <li>- Overload alarm indicator</li> <li>- Low oil alarm indicator</li> </ul> </li> </ol> |
|-------------------------------------------------------------------------------------------------------------------------------------------------------------------------------------|------------------------------------------------------------------------------------------------------------------------------------------------------------------------------------------------------------------------------------------------------------------------------------------------------------------------------------------------|

## FUEL SWITCH

**OFF** - Fuel supply off.

**ON** - Fuel supply on.

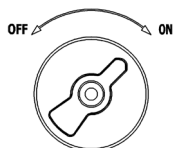

## ENGINE SWITCH

**OFF:** Ignition circuit off; generator stops.

**ON:** Ignition circuit on; generator OK to START.

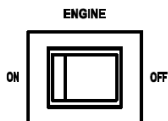

## ENGINE START BUTTON

When FUEL SWITCH and the ENGINE SWITCH are both in the ON position, press the ENGINE START button

① Press button (green) - The generator will automatically start (after a few seconds).

### ENGINE START



## REMOTE CONTROL

When the FUEL SWITCH and ENGINE SWITCH are both in the ON position, press START ① on the remote control and the generator will automatically start (after a few seconds). Press STOP ② on the remote control to shutdown.

① START

② STOP

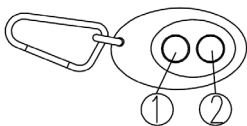

**! NOTE:** The remote start distance may be shorter due to obstacles or battery power reduction. It is suggested to not exceed 20 metres.

## ECO SWITCH

**ON:** When the ECO SWITCH is ON the generator runs at idle speed with no load. When a load is connected, it runs at various RPMs as per the load, which reduces fuel consumption and lowers the noise level.

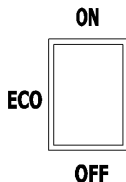

**OFF:** The generator will run at its full rated RPM. This suits equipment that require a high initial output or for equipment that require high continuous output.

**! NOTE:** The ECO SWITCH must be set to OFF for equipment that require a high starting current. E.g. Compressor submersible pump.

## AC OUTLET (230V - 50HZ)

This generator is fitted with two IP23 rated 230V outlets with weather covers.

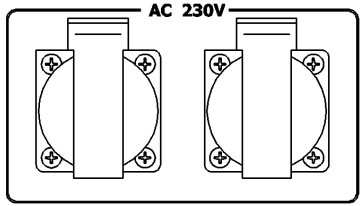

## LED INDICATORS

### ① OUTPUT INDICATOR (GREEN)

When the generator is started. The OUTPUT INDICATOR will turn ON continuously to show that there is an output of power.

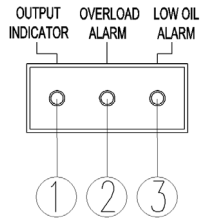

### ② OVERLOAD ALARM and RESET BUTTON (RED)

When the total power of connected electrical devices detected is too close to the rated power, the OVERLOAD ALARM indicator will turn ON and blink.

When the total power of connected electrical devices detected overloads the generator, the OVERLOAD ALARM indicator will turn ON continuously. The electrical breaker will activate to stop the power generation in order to protect the generator and connected electric devices. The OUTPUT INDICATOR will turn OFF, and the OVERLOAD ALARM indicator will stay ON. The generator will continue to run.

When the generator stops output due to an overload, disconnect all electric devices and reduce the total power of connected electric devices to a range in the limit of the generators rated power. Press the RESET BUTTON and the generator will reset the power output.

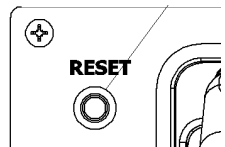

**! NOTE:** The generator will automatically reset the power output when the generator is stopped and restarted. The overload indicator may flicker for a number of seconds initially. When using electric devices that require a high starting current, such as compressor or submersible pump. It is not a fault.

### ③ LOW OIL ALARM (YELLOW)

When oil level falls below the lower limit, the LOW OIL ALARM indicator will turn on and the engine will automatically shutdown. Unless you refill the oil the engine will not restart.

**! NOTE:** If generator will not start, please turn the FUEL SWITCH to the ON position, and then pull the recoil starter. If the LOW OIL ALARM light flickers for a few seconds, it means that the oil is insufficient. Refer to page 30 to add/change the oil.

## VOLTS / FREQUENCY (HERTZ) / HRS

This generator is equipped with a digital display that provides a continuously updated status of information for the following;

- (V) Voltage output for the generator
- (Hz) Hertz output for the generator
- (Hr) The total run time since the first start (in hours)

**! NOTE:** It is normal for the run time indicator to have 1-2hours on the meter from the factory for testing and quality assurance inspections.

The digital display will illuminate when the engine is turned on. Within a few seconds of illumination, the display will begin to show new data, and at that point the generator is ready to supply power. The display will show each reading for a few seconds and repeat the cycle continuously while running.



Voltage



Hertz



Time (in hours) since generator was first started

## PRE-OPERATION CHECK

**⚠ NOTE:** Pre-operation checks should be made each time before using generator.

### FUEL

Remove the fuel tank cap. Add fuel up to the lower red mark of fuel filter, and then replace the fuel tank cap until you hear a clicking sound (Which means the fuel tank cap is fully tightened).

#### Recommended fuel:

Unleaded petrol: #92 or above

Fuel tank capacity: 7.0L

- ① Red mark in fuel filter
- ② Fuel level

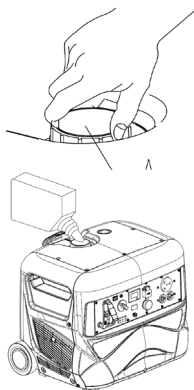
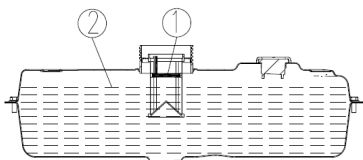

**⚠ NOTE:** If there is any spilled fuel, use a clean and dry soft cloth to wipe area to avoid corrosion on surface or plastic parts.

**⚠ NOTE:** Only use recommended unleaded fuel. Other types may cause serious damage to engine and inner components.

**⚠ WARNING:** Fuel is highly flammable and poisonous. Check and read SAFETY INFO (page 9) before refueling.

**⚠ WARNING:** DO NOT fill above the red mark in the fuel filter as it may overflow if the fuel heats up and expands. Make sure to tighten the fuel tank cap after refueling.

**⚠ WARNING:** DO NOT refuel with engine running. Allow generator to cool down for five minutes before refueling.

**⚠ WARNING:** DO NOT leave generator in a hot car or directly in the sun for long periods of time. Fuel vapors can cause the fuel tank to expand, which can cause cracks/leaks to occur. Expansion may even cause an explosion.



## ENGINE OIL

For new unit or changing oil, place the generator horizontally, remove the maintenance cover (See page 30), take out oil plug and fill with 600ml of recommended oil until the oil reaches the lower level.

When refilling, the oil level should be at the same level of oil port lower level. Assemble the oil plug and maintenance cover in reverse procedures (See page 27 for cover removal).

- ① Oil port lower level.
- ② Oil port
- ③ Oil plug

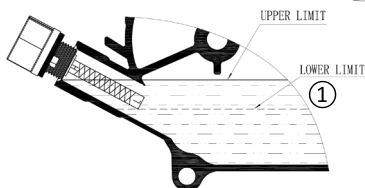
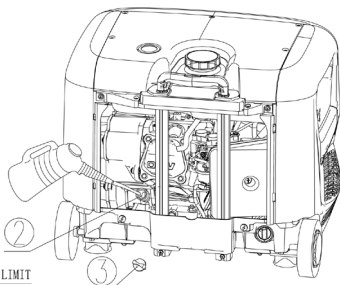

**!** NOTE: The generator leaves the factory without engine oil.

**!** NOTE: Do not tilt the generator when filling engine oil. This may result in overfilling and potential damage to the generator.

## RECOMMENDED ENGINE OIL

A: SAE15W-40

B: SAE10W-30

C: SAE5W-30

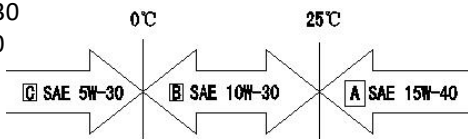

## ENGINE OIL CAPACITY

600ml

**!** NOTE: Do not over fill, fill to oil indicator line only.

## GROUND TERMINAL (EARTH BOLT/NUT)

The ground terminal on this generator is connected to NON-current carrying parts of the generator frame and to each AC outlet.

Before attaching a ground (earth) lead, consult with a qualified electrician on the intended use of this generator.

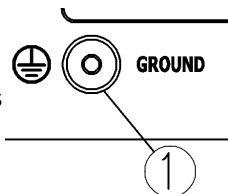

- ① Ground (earth) terminal

## BATTERY (MULTI-FUNCTION POWER PACK)

The generator uses a multi-function power pack as its battery for starting the generator.

This power pack also features multiple charging points. Including; two USB outlets, one MICRO USB outlet and a DC 12V outlet for charging a range of equipment such as mobile phones, laptops, etc. There is also a torch, a jump starter for emergency starting of a car, and a seatbelt cutter.

**⚠ NOTE: The generator leaves the factory with multi-function power pack not connected.**

## CONNECT MULTI-FUNCTION POWER PACK

Ensure the multi-function power pack is connected before starting the generator. To access, remove the power pack cover and connect the two cables. See below.

- ① Two screws
- ② Battery cover
- ③ Multi-function power pack (battery)
- ④ Connecting cable
- ⑤ Charging cable

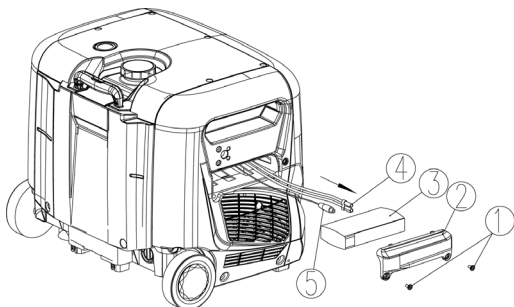

## OPERATION INSTRUCTIONS

**!** **WARNING:** Always operate generator in a well ventilated area. Never operate generator in a closed in area as it may cause unconsciousness or even death within minutes.

**!** **NOTE:** Clean dust, dirt or water off the socket before use.

**!** **NOTE:** Before starting the engine, do not connect any electrical devices.

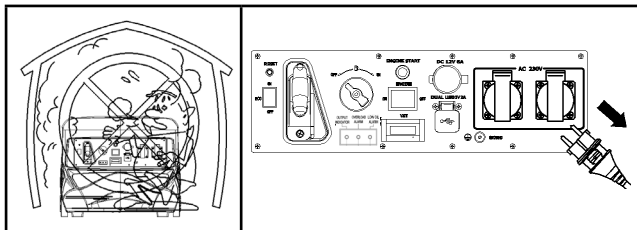

**!** **NOTE:** Read PRE-OPERATION CHECK (See page 16) carefully before operation of generator.

**!** **NOTE:** Generator can be used at rated output load in standard atmospheric conditions as follows:

- Ambient temperature: 25°C
- Atmospheric pressure: 1000KPa
- Relative humidity: 30%

The generator output may differ due to changes in temperature, altitude (the higher altitude, the lower air pressure) and humidity.

## STARTING THE GENERATOR

The generator has three types of starting, including ELECTRIC START, REMOTE START and RECOIL START.

### ELECTRIC START

1. Turn the ENGINE SWITCH to ON.
2. Turn the FUEL SWITCH to ON.
3. Turn ECO SWITCH to OFF.
4. Press the ENGINE START button (green) to start the generator (once only). Do not hold button down.

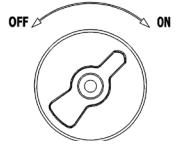
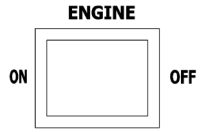

### ENGINE START

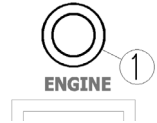

### REMOTE START

1. Turn the ENGINE SWITCH to ON.
2. Turn the FUEL SWITCH to ON.
3. Turn ECO SWITCH to OFF.
4. Press START (once only) on the remote control and the generator will start automatically (after a few seconds). Do not hold button down.

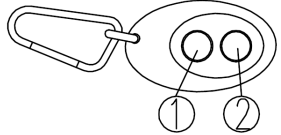

- ① START
- ② STOP

### RECOIL START

1. Turn the ENGINE SWITCH to ON.
2. Turn the FUEL SWITCH to ON.
3. Turn ECO SWITCH to OFF.
4. Pull slowly on the recoil start handle until engine compression has reached maximum resistance. Carefully allow the recoil start handle to fully retract. Then pull smoothly and swiftly to START.

**⚠ NOTE:** After the generator has warmed-up, place ECO SWITCH in the ON position and run the generator in economy mode.

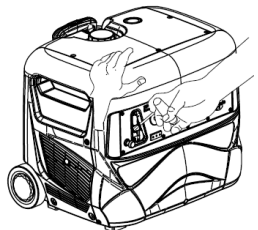



**NOTE: WHEN STARTING GENERATOR**

**ONLY USE** Australian standard approved extension cords and appliances.

Inspect all appliances power-leads for any damage or exposed wires. Check for any damage to appliances before connecting to the generator. If damaged - **DO NOT** use the appliance.

This unit is fitted with an automatic choke device. There is no external choke lever fitted.

The remote start distance may be shorter due to obstacles or battery power reduction. It is suggested to not exceed 20 metres.

During electric start or remote start, just press the **ENGINE START** on generator or **START** on remote control **ONCE ONLY**, the generator will start automatically (after a few seconds). There is no need to hold the button for an extended time.

When starting the generator, place **ECO SWITCH** in the **OFF** position, and ensure no load is connected to the generator.

In ambient temperatures below 3°C (37°F), the generator should run at idle speed for 5 minutes to warm up.

In ambient temperature above 3°C (37°F), the generator should run at idle speed for 3 minutes to warm up.

## APPLICATION RANGE

When using the generator, please make sure total load is lower than the generators rated output, or the generator may be damaged.

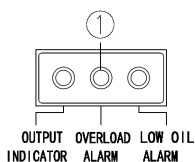

The simultaneous usage of AC and DC power is OK, but the total load should not exceed the maximum rated output, otherwise the generator will activate auto-protection status, or damage may occur.

Some electrical appliances or general-purpose electric motors have high starting currents, and may not run, even if they lie within power range.

**! NOTE: The overload alarm indicator ① is on (red) When total watts exceed the application range. See page 14 for more details.**

**! NOTE: This generator is not designed for medical applications.**

**! WARNING: Do not overload. The total load of all electrical devices must not exceed the range of the generator rated power. Constant overloading will damage the generator.**

## AC CONNECTION (POWERING EQUIPMENT)

1. Check that the total load is within generators rated output.
2. Check that the socket load current is within sockets rated current.

**! NOTE: Be sure all electric devices including lines and plugs connections are in good condition before connecting to the generator.**

**! WARNING: Be sure all electric devices are turned off before connecting to generator.**

**! WARNING: DO NOT run generator for extended periods with no load or minimal load (Eg. When charging batteries or powering low wattage equipment such as TVs and Radios). This may cause premature spark plug failure, excessive carbon build up or high oil consumption. To prevent this, run the generator periodically with an increased load.**

## START THE GENERATOR

**! WARNING:** Inspect all appliances for damage before using on generator. If damaged - do not use the appliance.

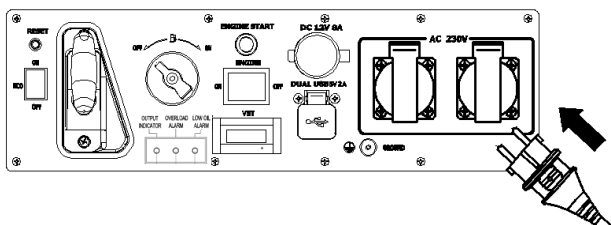

2. Connect the plug with the AC socket.

3. Make sure the output indicator is ON (Green).

① Output indicator

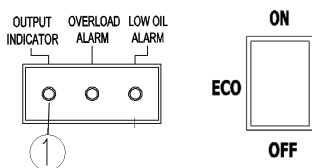

4. Turn the ECO SWITCH to the ON position , and then turn on electric devices (one by one).

**! NOTICE:** When using electric devices that require a large starting current, such as an air-conditioner, compressor, submersible pump, or high-power DC equipment, the ECO SWITCH must be placed to OFF position.

## DC CONNECTION (BATTERY CHARGING)

**⚠ WARNING:** Never connect with VRLA (valve regulated lead-acid) battery also commonly known as sealed or maintenance free battery, which requires special (constant voltage) charging. Before attempting to charge a battery using the DC outlet, ensure that the battery is compatible with the unregulated DC charging. VRLA batteries are not compatible with this generator.

### DC OUTLET CONNECTION

DC Output: 12V/8 Amp

This is applicable to devices or battery charging in this range of voltage and power.

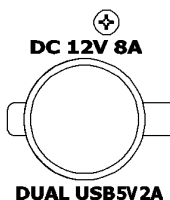

**⚠ NOTICE:** To avoid short circuit, connect charging line to battery terminal first, then to generator DC socket. After charging, disconnect the generator terminal first.

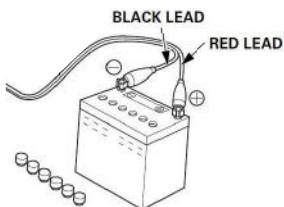

### USB CONNECTION

USB Port (dual)

DC Output: 5V/2 Amp

This is applicable to devices or battery charging in this range of voltage and power.



**⚠ WARNING:** - Battery electrolyte is poisonous and dangerous, causing severe burns, etc. It contains sulfuric acid. Avoid contact with skin, eyes or clothing.

1. CONTACT WITH SPILL: Wash with water.
2. CONTACT WITH EYES: Flush with water for 15 minutes and get prompt medical attention.

Batteries produce explosive gases. Keep sparks, flame, cigarettes, etc, away. Always ventilate when charging. Cover eyes when working near batteries. Keep battery out of reach of children.



## STOPPING THE GENERATOR

1. Disconnect all electric devices, and place ECO SWITCH to the OFF position.

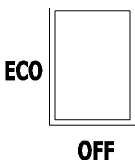
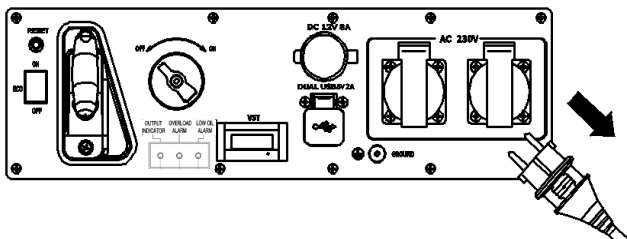

2. Turn the ENGINE SWITCH to the OFF position or press the STOP button (2) on the remote control.

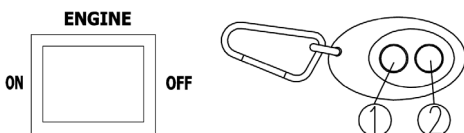

3. Turn the FUEL SWITCH to the OFF position.

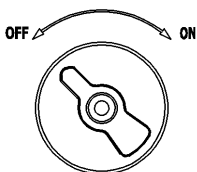

## PERIODIC MAINTENANCE

It is an owners requirement to periodically inspect, adjust, lubricate and maintain their generator to keep it in good working condition.

**⚠ WARNING: Consult your local service agent for all major maintenance work. Stop the engine and allow the engine to cool before starting maintenance work. Disconnect multi-function power pack, turn ENGINE SWITCH to OFF to avoid any accidental start up.**

**⚠ NOTE: Use only genuine parts for replacement, contact you local authorised service agent.**

Item	Description	Pre-operation check	Every 6 months or 100 hour	Every 12 months or 300 hour
Spark Plug	Check condition, clean and replace if necessary		○	
Fuel	Check fuel level and leakage	○		
Fuel hose	Check fuel hose for cracks or damage. Replace if necessary.			○
Engine oil	Check oil level in engine	○	○	
	Replace		○ (1)	
Air filter element	Check condition and clean		○ (2)	
Spark arrester element	Check condition, clean and replace if necessary		○	
Fuel filter	Clean and replace if necessary			○
Breather air hose	Check breather hose for cracks or damage. Replace if necessary.			○
Cylinder head	De-carbonise combustion chamber, inlet valve, and exhaust valve of cylinder head. More frequently if necessary			●
Valve clearance	Check and adjust when engine is cold.			●
Fittings/ fasteners	Check all fittings and fasteners. Correct if necessary.			●
General inspection	Check machine over for any abnormality.	○		

**(1) Engine Oil** - Initial replacement of engine oil is after 1 month or 20 hours of operation.

**(2) Air Filter Element** - When using in unusually wet or dusty areas, more frequent cleaning is required.

● **12 Months or 300 Hr** - Contact your local authorised service agent to conduct this service

## SPARK PLUG & AIR FILTER INSPECTION / OIL REPLACEMENT

Remove maintenance cover first (see below), then inspect spark plug and air filter, and change oil. After inspection and maintenance of related items, re-assemble the maintenance cover.

### MAINTENANCE COVER REMOVAL/ASSEMBLY

1. Loosen screws ① and lightly push/slide the cover ② upwards until cover disengages with the locating lugs (B) in the left and right covers.

**! CAUTION: DO NOT use excessive force when removing cover as this may result damaging the locating lugs or connector holes.**

2. Inspect and maintain related items (Refer to below related info).

- |                     |                   |
|---------------------|-------------------|
| ① Screws (2pcs)     | ④ Top housing     |
| ② Maintenance cover | ⑤ Air inlet cover |
| ③ Exhaust cover     |                   |

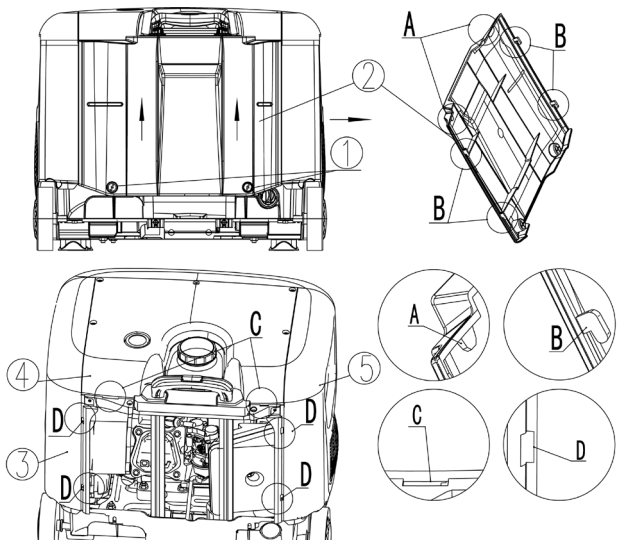

Connector A (2pcs) on maintenance cover matches the holes on Connector C (2pcs) on the top plastic housing ④. Connector B (4pcs) on maintenance cover matches the holes on Connector D (4pcs) with 2pcs on air inlet cover ⑤ and 2pcs on exhaust cover ③.

## SPARK PLUG INSPECTION

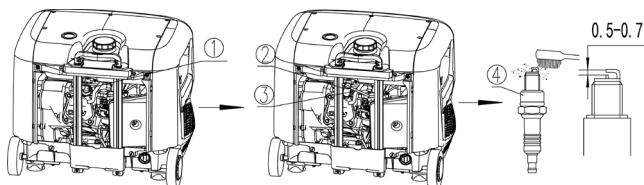

- ① Spark plug cap
- ② Spark socket
- ③ Two-way Screwdriver
- ④ Spark plug

1. Remove spark plug cap ①, locate spark plug socket ② on spark plug, turn it counterclockwise with screwdriver ③, and then disassemble spark plug ④.
2. Check for discoloration and remove the carbon. Standard electrode color: Medium-to-light tan color.
3. Check spark plug type and clearance. Standard spark plug: F7TC TORCH / BPR6EH NGK  
Spark plug clearance: 0.5-0.7mm
4. Install and tighten spark plug.
5. Assemble spark plug cap, and maintenance cover as per procedure.

**⚠ NOTE: When installing spark plug, twist it for 2-3 rounds by hand and tighten using the spark plug spanner supplied.**

## AIR FILTER INSPECTION

- ① Screw
- ② Air filter cover
- ③ Air filter

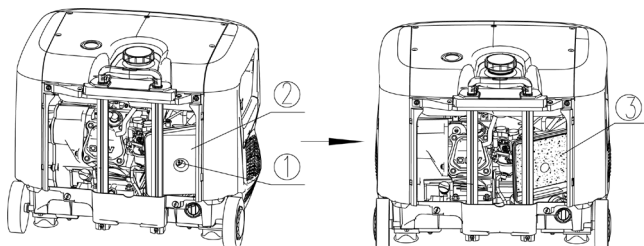

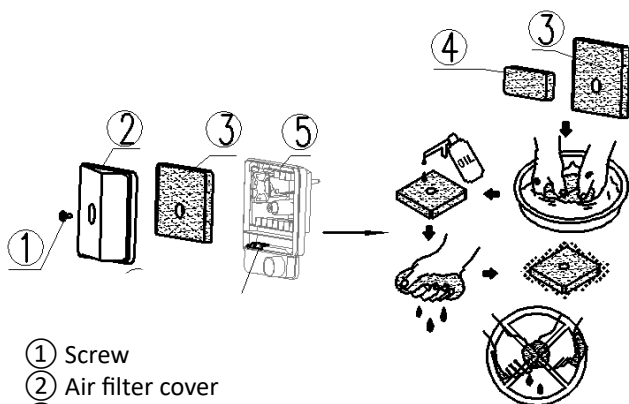

- ① Screw
- ② Air filter cover
- ③ Air filter
- ⑤ Air filter body

1. Loosen screw ①, remove air filter cover ②, take out air filter ③ of air filter body ⑤.
2. Clean element with solvent, and dry with a soft clean cloth. Apply a light coat of engine oil to the element and rub in evenly by hand. Gently squeeze out any excessive oil.

**!** NOTE: DO NOT wring out the element sponge, as it can be damaged.

3. Insert air filter element to air filter body and check for an even fit.
4. Assemble air filter cover, and tighten it with screws.
5. Assemble maintenance cover, and tighten the screws.

**!** WARNING: Never run the generator without element or it may cause excessive poisonous gas and cylinder wear.

## OIL REPLACEMENT

**! WARNING:** Never drain engine oil immediately after turning off engine. Let the engine cool first to avoid scalding.

1. Place generator on a level surface, and start engine for few minutes to reduce the engine oil viscosity. Shut-off the engine and remove maintenance cover as per procedure.

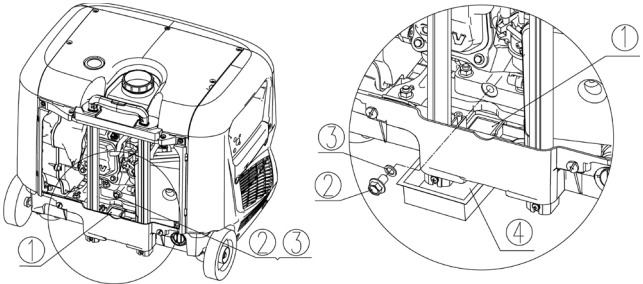

- ① Rubber gasket
- ② Oil drain screw
- ③ Aluminum gasket
- ④ Oil container

2. Remove rubber gasket ① of oil drain hole from bottom plate (pull up from bottom plate). Place an oil container ④ bigger than 1L below generator, remove oil drain screw ② and aluminum gasket ③. Tilt the generator to drain all oil. (If possible, a more convenient way is to use a siphon to drain the oil from engine crankcase.)

**! NOTE:** Replace aluminum gasket if damaged or if there are leaks when it is refitted.

3. Take oil container away, refit drain plug and aluminum gasket and insert it into oil drain port, screw it by hand, and tighten with a spanner. Re-assemble rubber gasket on oil drain port.

4. Place generator horizontally, and fill oil to oil port lower limit ①. See page 17 for oil type, filling, etc.

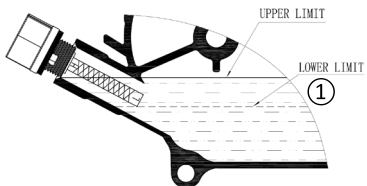

5. Wipe any spilled oil around oil port, and tighten oil plug to oil port.
6. Re-assemble maintenance cover.

**! WARNING: DO NOT tilt the generator when filling oil. This would result in overfilling and may damage the engine.**

- Be sure no other material enters the engine crankcase.
- Dispose of oil in an environmentally safe way

### SPARK ARRESTER ELEMENT

When an abnormal noise happens from engine, or output power is reduced, it may be caused by a blocked spark arrester element. Please check the spark arrester for build-up of carbon or any other materials.

**! CAUTION: Before checking, ensure generator has cooled.**

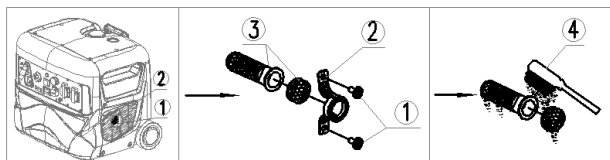

- ① Screw (2pcs)
- ② Ring flange
- ③ Element, spark arrester
- ④ Steel brush

1. Loosen screws on both side of exhaust outlet, and remove ring flange and spark arrester element.
2. Take out spark arrester element, and remove the carbon deposit with a wire brush.

**! NOTE: When cleaning, use a soft wire brush to lightly brush avoiding damaging or scratching spark arrester element.**

3. Check the spark arrester element. Replace it if damaged or blocked and beyond cleaning.
4. Re-assemble spark arrester element onto muffler, and ring flange, tighten the screws on both sides.

## FUEL TANK FILTER

1. Open fuel tank cap ①, and take out fuel filter ② from fuel port.
2. Check the filter screen. Replace it if damaged. Lightly tap out any dry debris in filter and wash with fuel only. DO NOT use water to clean filter.

**!** NOTE: Dispose of used petrol in an environmentally safe way.

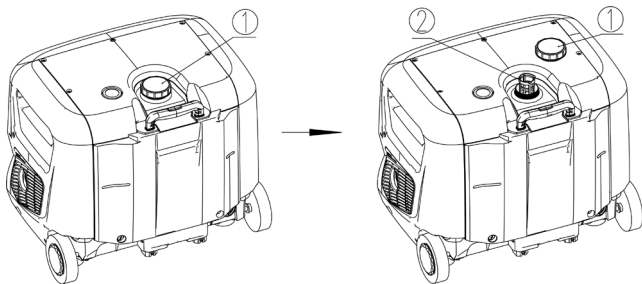

- ① Fuel tank cap
- ② Fuel filter

3. Wipe the filter clean, and re-assemble it into fuel tank port. Ensure red fuel fill level indicator is fitted after cleaning.
4. Replace fuel tank cap until a clicking sound occurs. This means the fuel tank cap has been fully tightened.

**!** CAUTION: Make sure to tighten fuel tank cap to avoid fuel spillage.

## TROUBLESHOOTING

### GENERATOR WILL NOT START / HAS NOT OUTPUT

1. CHECK SWITCHES are in the ON position, and turn ON if they are OFF.
  - ENGINE SWITCH is ON
  - FUEL SWITCH is ON
  - RESET BUTTON has not engaged
2. CHECK LOW OIL ALARM is flashing (Yellow)
  - If the indicator flashes, oil is insufficient.
  - Fill the oil to the correct levels. See page 17. Restart generator.



### 3. INSUFFICIENT FUEL

- Check fuel gauge window on top of generator. If red mark on side of E (as illustration), it means insufficient fuel. Refuel generator.

- ① Fuel gauge window
- ② Red fuel level mark
- ③ E—Empty
- ④ F—Full

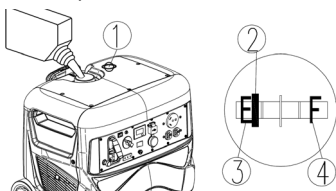

### 4. FUEL SUPPLY BLOCKED

- Carburetor blocked.

Stale fuel inside the carburetor will not combust. The solution is to loosen carburetor fuel drain screw ①, turn on FUEL SWITCH to ON position and let fuel flow out of the carburetor for 10-20s (collecting it in a tray) ④. If no fuel flows out after loosening fuel drain screw in above operation, it means fuel supply might be blocked. Consult your local service agent.

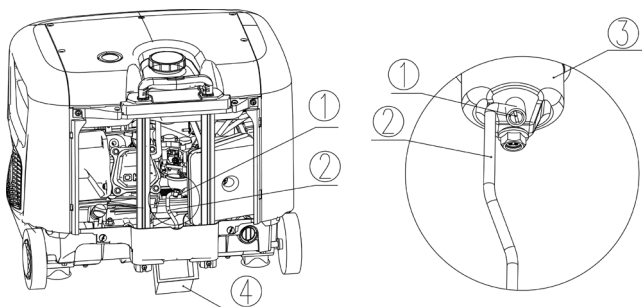

### 6. AIR FLOW BLOCKED

- Air filter element blocked. Refer to page 28.
- Spark arrestor blocked. Refer to page 31.

### 7. POOR SPARK

• Spark plug is dirty with carbon or wet. Remove carbon or wipe and dry spark plug. Check spark plug clearance 0.5~0.7mm. Replace it if there is over tolerance. Faulty ignition system: Consult the local service agent.

### 8. OVERLOADING and generator no output

- Refer to page 15 and LED Indicators.

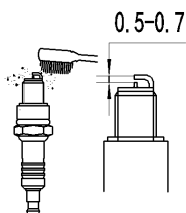

## STORAGE

For long term storage of your machine, follow these preventive procedures to guard against deterioration. Keep generator in a well ventilated area.

### DRAIN THE FUEL

1. Start the generator. See page 20 for instructions.
2. Turn the FUEL SWITCH to OFF position.
3. The generator will shut down automatically after using up all remaining fuel inside carburetor.
4. Set the ENGINE SWITCH to OFF position.
5. Remove fuel tank cap, siphon fuel from fuel tank into an approved fuel container. Replace fuel tank cap.

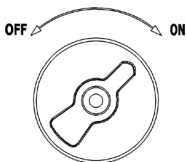

**! NOTE:** Please use an appropriate fuel container during fuel drain. The drained fuel should kept in approved fuel container.

**! WARNING:** Fuel used in the machine is highly flammable and poisonous. Check SAFETY INFORMATION on page 9 carefully before adding the fuel. Make sure to wipe up any spilled fuel immediately to avoid damage on rubber or plastic parts.

### MULTI-FUNCTION POWER PACK (BATTERY)

1. Set the ENGINE SWITCH to OFF position.
2. If the generator is stored for more than 2-3 months, it is suggested to charge the power pack once every month to extend the battery life.

### PROTECT THE ENGINE

In order to protect the engines cylinder, piston rings and other parts, please proceed as following steps:

1. Turn the ENGINE SWITCH and FUEL SWITCH to the OFF position.
2. Remove the spark plug, pour about one tea spoon (5ml) SAE10W-30 or 15W-40 oil into the spark plug hole, and then re-install the spark plug. Pull the recoil starter for several times to coat the cylinder wall, piston rings and other parts with oil. (You can do this after DRAINING THE FUEL)

3. Pull the recoil starter until you feel compression and then stop pulling (This closes the valves and prevents moisture getting inside).
4. Clean the exterior part of the generator.
5. Store the generator in a dry and well-ventilated place.
6. The generator must remain in a vertical position when stored, carried and operated.

## TRANSPORT

When transporting the generator;

1. Do not overfill the tank; fuel level should be below red level indicator (there should be no fuel in the filler neck).
2. Do not operate generator while it is on a vehicle. The generator must be operated in a well ventilated area.
3. Avoid putting the generator on a vehicle exposed directly to sunlight. If the generator is left in an enclosed vehicle for many hours, the high temperatures inside the vehicle could cause fuel to vaporize resulting in possible explosion.
4. Do not drive on a rough road for an extended period with the generator on board. If you must transport the generator on a rough road, drain the fuel from the generator before hand.

## IDENTIFICATION

The machine identification series number is attached in the location as shown below.

- ① Machine series number

### SERIAL NUMBERS

-----  
(Write serial no.)



# WIRING DIAGRAM

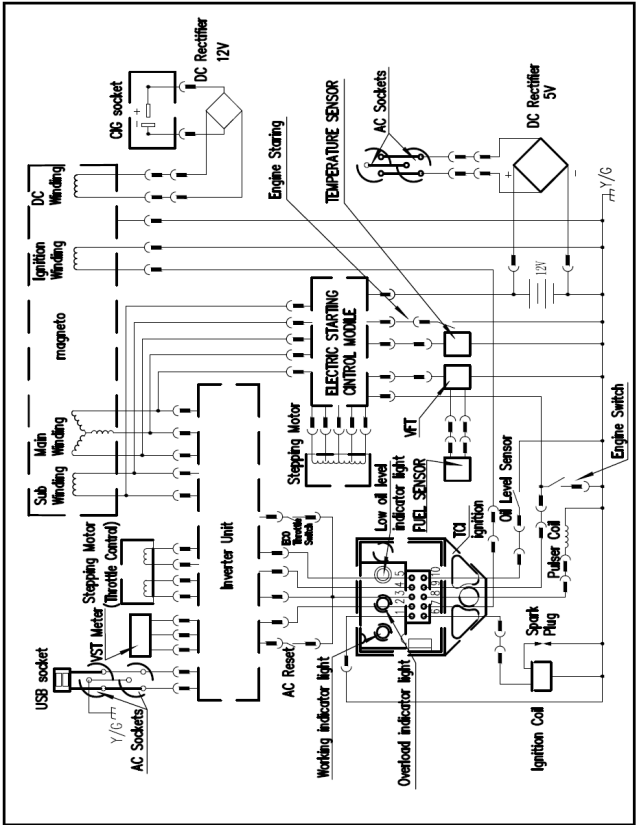



## CTG4500iE SPECIFICATIONS

<b>CROMTECH™ OUTBACK 4.5</b>	
<b>Max. Wattage</b>	4500watts
<b>Cont. Wattage</b>	3700watts
<b>Type</b>	Single Phase
<b>Voltage Regulation</b>	Inverter - Pure Sine Wave <2.5% THD
<b>Power Factor</b>	1.0
<b>Cromtech Engine</b>	6hp Cromtech LH170F (212cc)
<b>Engine Type</b>	4 stroke, air-cooled, single cylinder, OHV gasoline engine
<b>Engine Oil</b>	600ml
<b>Fuel Type</b>	Petrol Unleaded
<b>Fuel Tank</b>	7.0L
<b>Run Time</b>	4 to 12 hours (depending on load)
<b>Spark Plug</b>	F7RTC TORCH   BPR7ES NGK
<b>Starting System</b>	Electric start, Remote start and Recoil start
<b>Noise Level</b>	55 - 60Db at 7m*
<b>AC Outlets (x2)</b>	230V (IP23 rated)
<b>DC Outlet</b>	12V - 8 Amp
<b>USB Outlets (x2)</b>	5V - 2 Amp
<b>Weight (dry)</b>	37.7kg
<b>Dimensions (LxWxH)</b>	580 x 453 x 481mm
<b>Package Dimensions</b>	611 x 487 x 530mm
<b>Warranty</b>	1 Year Cromtech domestic warranty

\*Noise level is measured when the ECO SWITCH is ON. LWA shows the sound power level under the ISO3744 standard test condition. The decibel rating is measured at 7m from the generator (Noise level may vary in different environments).

**NOISE LEVEL** - The figures quoted are emission levels and are not necessarily safe working levels. Whilst there is a correlation between the emission and exposure levels, this cannot be used reliably to determine whether or not further precautions are required. Factors that influence the actual level of exposure of work-force include the characteristics of the work room, the other sources of noise, etc. I.e. the number of machines and other adjacent processes, and the length of time for which an operator is exposed to the noise. Also the permissible exposure level can vary from country.



## STANDARD FEATURES

- Single phase outlets (230V) with IP23 weather covers
- USB Outlets (5V-2 Amp)
- DC Outlet (12V-8Amp)
- Electric start with remote start
- Digital display (Volts, Hz and Hrs)
- Multi-function power pack with multiple charging points (2 x USB, 1x MICRO USB and DC 12V). Also includes; torch, jump starter for emergency starting of a car, and seatbelt cutter.
- 6.0hp Cromtech engine
- Petrol powered
- 7.0L fuel tank
- 4 to 12 hrs continuous running (depending on load)
- Pure Sine Wave <2.5% THD suits precise instruments
- Eco Switch adjusts output as load requires and lowers noise levels
- Super quiet running at 55-60Db at 7m
- Low oil alarm, overload alarm, output indicator
- Compact design with two wheels and suitcase styled extendable handle
- Convenient access ports
- 1 Year Cromtech domestic warranty

## APPLICATIONS

- Camping
- Caravanning & RVs
- Precision Instruments
- Small power tools
- Home/small office backup
- Fetes & Markets

## ACCESSORIES INCLUDED

- Spark plug
- Spark plug spanner
- Dust cover
- Multi-function power pack
- Remote start

**CROMTECH**  **OUTBACK** <sup>4.5i</sup>

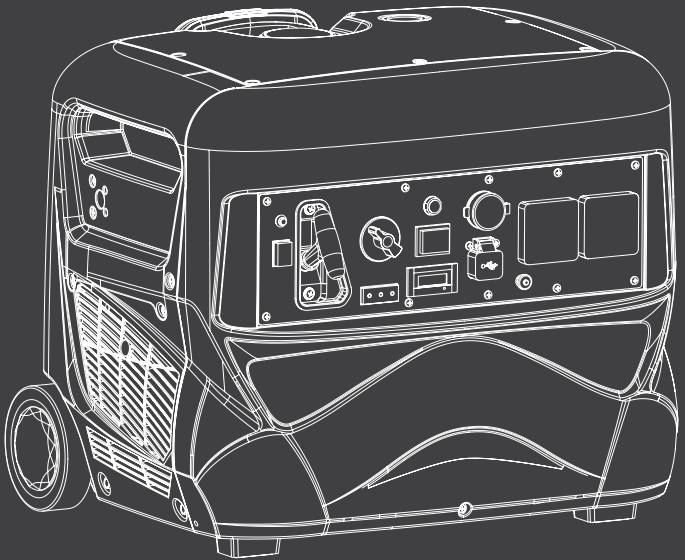

**CROMTECH OUTBACK 4.5i  
OPERATION MANUAL**