

MASTERVOLT

THE POWER TO BE INDEPENDENT

CHARGEMASTER PLUS





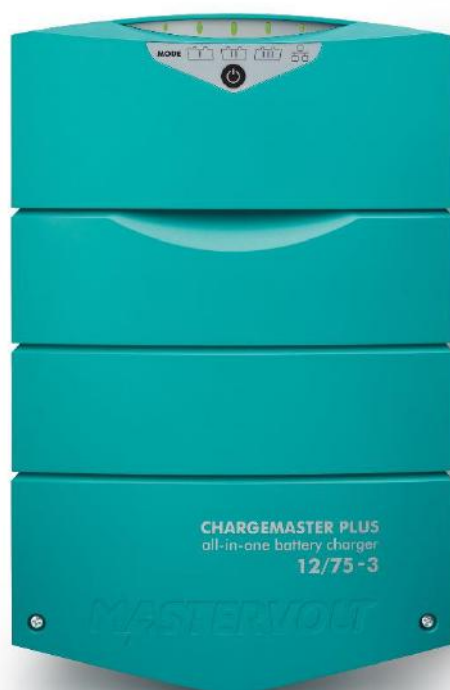

12/75-3, 12/100-3, 24/40-3, 24/60-3

ALL-IN-ONE BATTERY CHARGER



USER AND INSTALLATION MANUAL

10000015492/07

-  For the latest version of this manual, visit our website:
-  Ga om deze handleiding in andere talen te downloaden naar onze website:
-  Um diese Anleitung in anderen Sprachen herunterzuladen, besuchen Sie bitte unsere Website:
-  Pour télécharger ce manuel dans d'autres langues, consultez notre site Web :
-  Para descargar este manual en otros idiomas, visite nuestro sitio web:
-  Per scaricare questo manuale in altre lingue, visitare la pagina del prodotto sul nostro sito Web:

www.mastervolt.com

TABLE OF CONTENTS

1 GENERAL INFORMATION	3	3.8 Installation step-by-step	13
1.1 Use of this manual	3	3.9 Commissioning after installation	15
1.2 Liability	3	4 SETTINGS	16
1.3 Warranty.....	3	4.1 DIP switch settings.....	16
1.4 Disclaimer	3	4.2 MasterBus configuration	16
1.5 Identification label.....	3	4.2.1 Monitoring	17
1.6 Correct disposal of this product	3	4.2.2 Alarms.....	18
2 SAFETY INSTRUCTIONS	4	4.2.3 History.....	18
2.1 General.....	4	4.2.4 Configuration settings.....	19
2.2 Explosive gases.....	4	4.2.5 Events – System automation	21
2.3 Personal precautions.....	5	4.2.6 Current control	22
2.4 Warnings regarding the use of batteries	5	4.3 MasterShunt	22
2.5 Charger location	5	4.4 Li-ion Battery MLI Ultra	22
2.6 DC connection precautions.....	5	4.5 CZone configuration.....	23
2.7 When battery is installed in vehicle	6	5 OPERATING INSTRUCTIONS	25
2.8 When battery is outside vehicle	6	5.1 Introduction.....	25
2.9 Preparing to charge.....	6	5.2 Switching on / off	25
2.10 Grounding instructions.....	7	5.3 Status display	25
2.11 Warning regarding life support applications.....	7	5.4 The 3-step+ charge process	26
3 INSTALLATION	8	5.4.1 Charge voltages	27
3.1 Unpacking.....	8	5.4.2 Pre-float	27
3.2 Location.....	8	5.4.3 Temperature compensated charging.....	27
3.3 Wiring	8	5.4.4 Flat battery support.....	27
3.3.1 DC wiring.....	8	5.5 DC 3 IN/OUT.....	28
3.3.2 AC wiring.....	9	5.6 Maintenance	29
3.3.3 AC safety grounding.....	9	5.7 Storage.....	29
3.3.4 Network wiring (CZone/MasterBus).....	9	6 TROUBLE SHOOTING	30
3.4 Batteries	10	7 TECHNICAL DATA	32
3.5 Things you need	10	7.1 Specifications 12V models	32
3.6 Overview of the connection compartment	11	7.2 Specifications 24V models	33
3.7 Connection example	12	7.3 Dimensions	34
		7.4 Characteristics	34

1 GENERAL INFORMATION

1.1 Use of this manual

This manual serves as a guideline for the safe and effective operation and maintenance of the following ChargeMaster Plus models:

Part number	Model
44310755	12/75-3
44311005	12/100-3
44320405	24/40-3
44320605	24/60-3

These models are further referred to as "ChargeMaster Plus".

1.2 Liability

Mastervolt can accept no liability for:

- Consequential damage resulting from the use of the ChargeMaster Plus.
- Possible errors in the included manual and the consequences of these.
- Use that is inconsistent with the purpose of the product.

1.3 Warranty

The Mastervolt product warranty covers the ChargeMaster Plus for the first two years after the purchase date, on the condition that the product is installed and used according to the instructions in this manual.

Installation or use that do not comply with these instructions may result in under performance, damage or failure of the product and may void this warranty. The warranty is limited to the cost of repair and/or replacement of the product. Costs of labor or shipping are not covered by this warranty.

1.4 Disclaimer

Our products are subject to continual development and improvement. Therefore, additions or modifications to the products may cause changes to the technical data and functional specifications. No rights can be

derived from this document. Please consult our most current Terms & Conditions of Sale.

1.5 Identification label

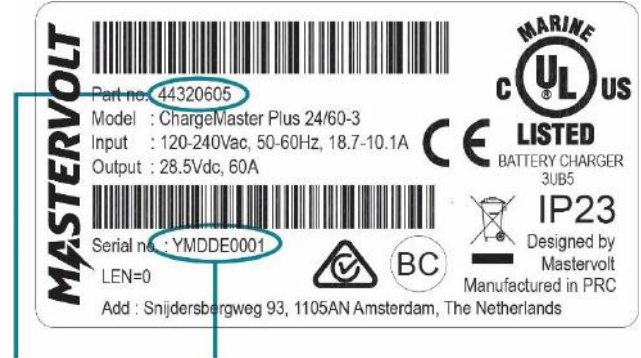

Part number Serial number with device version "E".

Figure 1: Identification label

The identification label is located at the right-hand side of the ChargeMaster Plus. Important technical information required for service, maintenance & secondary delivery of parts can be derived from the identification label.



CAUTION!

Never remove the identification label. This will void the warranty.

1.6 Correct disposal of this product



This product is designed and manufactured with high quality materials and components, which can be recycled and reused.

Please be informed about the local separate collection system for electrical and electronic products.

Please act according to your local rules and do not dispose of your old products with your normal household waste. The correct disposal of your old product will help prevent potential negative consequences to the environment and human health.

2 SAFETY INSTRUCTIONS

IMPORTANT SAFETY INSTRUCTIONS SAVE THESE INSTRUCTIONS



WARNING!

Read the entire manual before using the ChargeMaster Plus. Keep this manual in a secure place.

This chapter describes important safety and operating instructions for use of a ChargeMaster Plus in residential, recreational vehicle (RV) and marine applications.

2.1 General

- 1 The appliance is not to be used by children or persons with reduced physical, sensory or mental capabilities, or lack of experience and knowledge, unless they have been given supervision or instruction.
- 2 This appliance can be used by children aged from 8 years and above and persons with reduced physical, sensory or mental capabilities or lack of experience and knowledge if they have been given supervision or instruction concerning use of the appliance in a safe way and understand the hazards involved.
- 3 Children shall not play with the appliance.
- 4 Cleaning and user maintenance shall not be made by children without supervision.
- 5 To reduce the risk of electric shock – Do not expose the ChargeMaster Plus to rain, snow, spray, moisture, excessive pollution and condensing circumstances. To reduce risk of fire hazard, do not cover or obstruct the ventilation openings. Do not install the ChargeMaster Plus in a non-ventilated room, as overheating may result.
- 6 Use of an attachment or spare part not recommended or sold by Mastervolt may result in a risk of fire, electric shock, or personal injury.
- 7 UL 1236 requirements do not cover investigation of charging Lithium-ion type batteries.
- 8 The ChargeMaster Plus is designed to be permanently connected to an AC and DC electrical system. Installation of, and work on the ChargeMaster Plus, may be carried out only by qualified and trained personnel, consistent with the locally applicable standards and regulations.
- 9 Make sure that all wiring is properly installed, in good electrical condition, and correctly sized to match the AC ampere rating of the ChargeMaster Plus. Check the wiring on a regular base, at least once a year. Do not use the ChargeMaster Plus when the wiring is undersized or damaged.
- 10 Do not operate the ChargeMaster Plus if it has received a sharp blow, been dropped, or otherwise damaged in any way; take it to a qualified serviceman.
- 11 Except for the connection compartment, see chapter 3, the ChargeMaster Plus may not be opened or disassembled. There are no serviceable parts inside the cabinet. Take it to a qualified, authorized and trained serviceman when service or repair is required. Incorrect reassembly may result in a risk of electric shock or fire.
- 12 To reduce risk of electric shock, disconnect the ChargeMaster Plus from both AC and DC electrical system before attempting any maintenance or cleaning. Turning off controls will not reduce this risk. Be sure that third parties cannot reverse the measures taken.
- 13 The ChargeMaster Plus must be provided with an equipment-grounding conductor to the AC input ground terminal. Grounding and all other wiring must comply with local codes and ordinances.
- 14 Short circuiting or reversing polarity will lead to serious damage to batteries, ChargeMaster Plus, wiring as well as accessories. Fuses cannot prevent damage caused by reversed polarity and the warranty will be void.
- 15 In case of fire, you must use the fire extinguisher which is appropriate for electrical equipment.
- 16 If applied in a marine application in the United States, external connections to the ChargeMaster Plus shall comply with the United States Coast Guard Electrical Regulations (33CFR183, Sub part I).

2.2 Explosive gases

- 1 **WARNING** – RISK OF EXPLOSIVE GASES. WORKING IN VICINITY OF A LEAD-ACID BATTERY IS DANGEROUS.

BATTERIES GENERATE EXPLOSIVE GASES DURING NORMAL BATTERY OPERATION. FOR THIS REASON, IT IS OF UTMOST IMPORTANCE THAT EACH TIME BEFORE USING THE ChargeMaster Plus, YOU READ THIS MANUAL AND FOLLOW THE INSTRUCTIONS EXACTLY.

- 2 To reduce risk of battery explosion, follow these instructions and those published by battery manufacturer and manufacturer of any equipment you intend to use in vicinity of the battery. Review cautionary marking on these products and on engine.
- 3 **DANGER:** To reduce the risk of explosion – Never use the ChargeMaster Plus in situations where there is danger of gas or dust explosion or area in which ignition-protected equipment is required.

2.3 Personal precautions

- 1 Consider having someone close enough by to come to your aid when you work near a lead-acid battery.
- 2 Have plenty of fresh water and soap nearby in case battery acid contacts skin, clothing, or eyes.
- 3 Wear eye and clothing protection. Avoid touching eyes while working near battery.
- 4 If battery acid contacts skin or clothing, wash immediately with soap and water. If acid enters eye, immediately flood eye with running cold water for at least 10 minutes and get medical attention immediately.
- 5 NEVER smoke or allow a spark or flame in vicinity of battery or engine.
- 6 Be extra cautious to reduce risk of dropping a metal tool onto battery. It might spark or short-circuit battery or other electrical part that may cause explosion.
- 7 Do not wear watches, bracelets, necklaces or other metal objects when working on batteries.

2.4 Warnings regarding the use of batteries

- 1 Only use the ChargeMaster Plus for charging Lead-Acid or lithium-ion batteries and the

supply of consumers attached to these batteries, in permanent systems. Do not use the ChargeMaster Plus for charging dry-cell batteries that are commonly used with home appliances. These batteries may burst and cause injury to persons and damage to property. Make sure lithium-ion batteries used for this charger are certified to IEC standards.

- 2 NEVER charge non-rechargeable batteries.
- 3 NEVER charge a frozen battery.
- 4 Excessive battery discharge and/or high charging voltages can cause serious damage to batteries. Do not exceed the recommended limits of discharge level of your batteries.
- 5 If it is necessary to remove a battery, always remove grounded terminal from battery first. Make sure all accessories are off, so as not to cause an arc.
- 6 Be sure that the area around battery is well ventilated while battery is being charged. Refer to the recommendations of the battery manufacturer.
- 7 Batteries are heavy! It may become a projectile if it is involved in an accident! Ensure adequate and secure mounting and always use suitable handling equipment for transportation.

2.5 Charger location

- 1 Never place charger directly above battery being charged; gases from battery will corrode and damage charger.
- 2 Never allow battery acid to drip on charger when reading electrolyte specific gravity or filling battery.
- 3 Do not operate charger in a closed-in area or restrict ventilation in any way.
- 4 Do not set a battery on top of charger.

2.6 DC connection precautions

- 1 Connect and disconnect DC output clips only after setting any charger switches to “off” position and removing AC cord from electric outlet. Never allow clips to touch each other.
- 2 Attach clips to battery and chassis as indicated in section 2.7, steps 5 and 6, and 2.8 steps 2 through 4.

2.7 When battery is installed in vehicle

A SPARK MAY CAUSE BATTERY EXPLOSION.

To reduce risk of a spark near battery:

- 1 Position AC and DC cords to reduce risk of damage by hood, door, or moving engine part.
- 2 Stay clear of fan blades, belts, pulleys, and other parts that can cause injury to persons.
- 3 Check polarity of battery posts. POSITIVE (POS, P, +) battery post usually has larger diameter than NEGATIVE (NEG, N, -) post.
- 4 Determine which post of battery is grounded (connected) to the chassis. If negative post is grounded to chassis (as in most vehicles), see (5). If positive post is grounded to the chassis, see (6).
- 5 For negative-grounded vehicle, connect POSITIVE (RED) clip from battery charger to POSITIVE (POS, P, +) ungrounded post of battery. Connect NEGATIVE (BLACK) clip to vehicle chassis or engine block away from battery. Do not connect clip to carburetor, fuel lines, or sheet-metal body parts. Connect to a heavy gage metal part of the frame or engine block.
- 6 For positive-grounded vehicle, connect NEGATIVE (BLACK) clip from battery charger to NEGATIVE (NEG, N, -) ungrounded post of battery. Connect POSITIVE (RED) clip to vehicle chassis or engine block away from battery. Do not connect clip to carburetor, fuel lines, or sheet-metal body parts. Connect to a heavy gage metal part of the frame or engine block.
- 7 When disconnecting charger, turn switches to off, disconnect AC cord, remove clip from vehicle chassis, and then remove clip from battery terminal.
- 8 See operating instructions for length of charge information.

2.8 When battery is outside vehicle

A SPARK MAY CAUSE BATTERY EXPLOSION.

To reduce risk of a spark near battery:

- 1 Check polarity of battery posts. POSITIVE (POS, P, +) battery post usually has a larger diameter than NEGATIVE (NEG, N, -) post.

- 2 Attach at least a 24-inch-long 6-gauge (AWG) insulated battery cable to NEGATIVE (NEG, N, -) battery post.
- 3 Connect POSITIVE (RED) charger clip to POSITIVE (POS, P, +) post of battery.
- 4 Position yourself and free end of cable as far away from battery as possible – then connect NEGATIVE (BLACK) charger clip to free end of cable.
- 5 Do not face battery when making final connection.
- 6 When disconnecting charger, always do so in reverse sequence of connecting procedure and break first connection while as far away from battery as practical.

2.9 Preparing to charge

- 1 If it is necessary to remove battery from vehicle to charge, always remove grounded terminal from battery first. Make sure all accessories in the vehicle are off, so as not to cause an arc.
- 2 Be sure area around battery is well ventilated while battery is being charged.
- 3 Clean battery terminals. Be careful to keep corrosion from coming in contact with eyes.
- 4 Add distilled water in each cell until battery acid reaches level specified by battery manufacturer. Do not overfill. For a battery without removable cell caps, such as valve regulated lead acid batteries, carefully follow manufacturer's recharging instructions.
- 5 Study all battery manufacturer's specific precautions while charging and recommended rates of charge.
Note that the ChargeMaster Plus charge specifications are based on Mastervolt batteries. Specifications for a given chemistry of a different manufacturer may vary. If connecting batteries of a different manufacturer, make sure the manufacturer's recommendations are met.
- 6 Determine voltage of battery by referring to car owner's manual and make sure that output voltage selector switch is set at correct voltage. If charger has adjustable charge rate, charge battery initially at lowest rate. Exception: For a charger not having an output voltage selector switch, determine voltage of

battery by referring to car owner's manual and make sure it matches output rating of battery charger.

2.10 Grounding instructions

This battery charger should be connected to a grounded, metal, permanent wiring system; or an equipment-grounding conductor should be run with circuit conductors and connected to equipment-grounding terminal or lead on battery charger. Connections to battery charger should comply with all local codes and ordinances.

2.11 Warning regarding life support applications

Mastervolt products are not designed to be used as component of medical equipment, unless negotiated in the form of a written agreement between customer and/or manufacturer and Mastervolt. Such agreement will require the equipment manufacturer either to contract additional reliability testing of the Mastervolt parts and/or to commit to undertake such testing as a part of the manufacturing process. Furthermore, the manufacturer must agree to indemnify and not hold Mastervolt responsible for any claims arising from the use of the Mastervolt parts in the life support equipment.

3 INSTALLATION

During installation and commissioning, the safety instructions are applicable at all times.

3.1 Unpacking

In addition to the ChargeMaster Plus the delivery includes:

- Mounting bracket to mount the ChargeMaster Plus to a wall;
- Battery temperature sensor;
- Drop cable CZone/MB (1m);
- MasterBus Terminator;
- User manual.

After unpacking, check the contents for possible damage. Do not use the product if it is damaged. If in doubt, contact your supplier

Check from the identification label (see section 1.2) whether the battery voltage is the same as the nominal output voltage of the ChargeMaster Plus (e.g. 24V battery set for a 24V battery charger).

3.2 Location

- The ChargeMaster Plus is designed for indoor use only.
- Ambient temperature: -25°C ... 80°C / -13°F ... 176°F; (power derating above 40°C / 104°F to decrease the internal heat sink temperature).

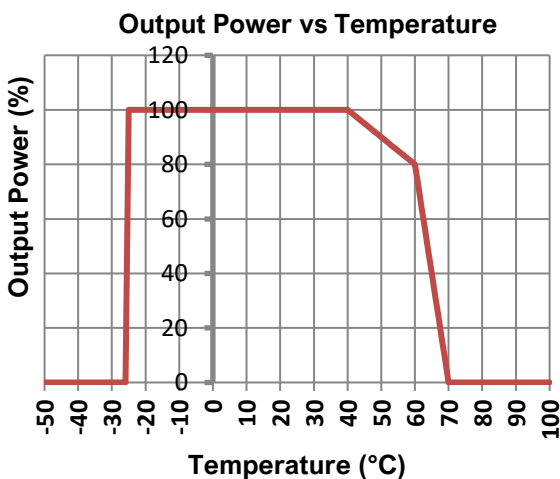

- Humidity: 0-95% non-condensing
- Mount the ChargeMaster Plus vertically, with the connecting cables downwards.
- Do not expose the ChargeMaster Plus to excessive dust, aggressive environments, ammonia or salt.
- Make sure that the hot air that is developed during operation can be discharged. The ChargeMaster Plus must be mounted in such

a way that obstruction of the airflow through the ventilation openings will be prevented.

- This device requires a minimum of 100mm (4") of clearance on every side.
- If added to a CZone or MasterBus network, take the network powering into consideration.
- Never place the ChargeMaster Plus directly above the battery being charged, as gases from battery will corrode and damage the ChargeMaster Plus.
- If the ChargeMaster Plus is installed in the immediate vicinity of living areas, take into account that the fan of the ChargeMaster Plus can produce noise when operating.
- Although the ChargeMaster Plus fully complies with all applicable EMC limits, it may still cause harmful interference to radio communication equipment. If such interference appears, it is recommended to increase the separation between the ChargeMaster Plus and the equipment, to relocate the receiving antenna or to connect the equipment to a circuit different from that to which the ChargeMaster Plus is connected.

3.3 Wiring



WARNING!

The wire sizes stated in this manual are given as guideline only. Always comply with all local rules and regulations.

3.3.1 DC wiring

Keep in mind that high current will pass through the DC wiring. Keep the cable length as short as possible, this will keep the system efficiency as high as possible. The recommended minimum cross section of the battery cables is:

ChargeMaster Plus model	DC Cable cross section:	
	<3m / 10ft	3-5m / 10-16ft
12/75-3	25mm ² / AWG2	35mm ² / AWG1
12/100-3	35mm ² / AWG1	50mm ² / AWG0
24/40-3	16mm ² / AWG4	25mm ² / AWG2
24/60-3	25mm ² / AWG2	35mm ² / AWG2

Use the following wire colors for DC wiring color or at least different colors to make a clear distinction between the positive and negative wire from the battery:

Wire color	Meaning	Connect to:
Red	Positive	+ (POS)
Black	Negative	- (NEG)

Run the positive and negative cables next to each other to limit the electromagnetic field around the cables. The negative cable should be connected directly to the negative post of the battery bank or the ground side of a current shunt. Do not use the chassis frame as the negative conductor. Tighten securely. The positive battery cable must be fused and connected to the positive post of the battery bank.

The recommended DC fuses for DC 1 OUT, DC 2 OUT and DC 3 in/OUT are:

Model	DC fuse	Model	DC fuse
12/75-3	85A	24/40-3	50A
12/100-3	125A	24/60-3	80A

The fuse with the fuse-holder is available from your local Mastervolt distributor or Customer Service Representative.

3.3.2 AC wiring



WARNING!

On first connecting to power, make sure the ChargeMaster Plus is in a well-ventilated area as it might spark.

For a safe installation the correct wire cross section must be applied. Don't use a cross section that is smaller than indicated. See the following table to select the appropriate cross section for the AC wiring (up to 6m / 20ft length):

AC Current	Minimum cross section:	
	in mm ²	AWG
6-12A	1.5mm ²	AWG14
12-20A	2.5mm ²	AWG12
20-32A	4.0mm ²	AWG10

Connection of AC wiring and recommended wire colors:

- 240VAC, 50/60Hz installations:

Wire color	Meaning	Must be connected to:
Brown or black	Phase	L1
Blue	Neutral	N
Green/Yellow	Earth	PE / GND

- 120VAC, 50/60Hz installations (single phase):

Wire color	Meaning	Must be connected to:
Black	Hot or Line	L1
White	Neutral	N
Green	Ground	PE / GND

- 240VAC, 50/60Hz (split phase 120/240VAC):

Wire color	Meaning	Must be connected to:
Black	Hot or Line	L1
Red	Hot or Line	L2
Green	Ground	PE / GND

Note: An accessible disconnection device (switch or circuit breaker for example) must be incorporated in the AC wiring, in accordance with wiring rules.

3.3.3 AC safety grounding



WARNING!

The ground wire offers protection only if the enclosure of the ChargeMaster Plus is connected to the safety ground. Connect the ground terminal (PE / GND) to the hull or the chassis.



CAUTION!

According to local regulations an RCD/Breaker (also known as GFCI) must be placed in the AC input circuit of the ChargeMaster Plus.

For Australia and New Zealand, the wiring rules are in accordance with AS/NZS 3000.

3.3.4 Network wiring (CZone/MasterBus)

The ChargeMaster Plus can be connected to a CZone or MasterBus network. Use an RJ45 Drop cable CZone/MB or MasterBus cable and daisy chain the ChargeMaster Plus to the other

devices, forming a local data network. Both networks need a terminating device on both ends of the network. Do not make ring networks or T-connections.

- **CZone network**

Points to consider:

- Up to 40 devices can be connected together on a single backbone.
- Make sure the CZone network has two terminating resistors, one at each open end of the backbone.
- The electric power for the network comes from a battery or power supply. Make sure that it delivers enough power and is positioned as close to the middle of the backbone as possible to reduce voltage drop.

- **MasterBus network**

Points to consider:

- Connections between the devices are made by standard MasterBus cables (straight UTP). Mastervolt can supply these cables.
- Up to 63 MasterBus devices can be connected together.
- The electric power for the network comes from the connected devices according to the rule: 1powering / 3 non-powering. Spread the powering devices over the network.

For more details on networks, please contact your Mastervolt supplier.

3.4 Batteries

Always follow the instructions published by the battery manufacturer.

Model	Minimum battery capacity
12/75-3	150 Ah
12/100-3	200 Ah
24/40-3	80 Ah
24/60-3	120 Ah

Minimum based on Mastervolt Gel batteries. If connecting batteries of a different manufacturer,

make sure the manufacturer's recommendations are met.

3.5 Things you need

Make sure you have all the parts you need to install the ChargeMaster Plus:

- ChargeMaster Plus (included).
- Battery temperature sensor with cable and plug (included).
- DC cables to connect the ChargeMaster Plus to the batteries and common negative; see section 3.3.1 for specifications.
- DC fuse holder with a DC fuse, to be integrated in the positive DC cable; see section 3.3.1 for specifications.
- Screws/bolts (Ø 6mm with plugs) to mount the ChargeMaster Plus to a surface. Use mounting materials which are suitable to carry the weight of the ChargeMaster Plus.
- AC cable to connect the AC input to an AC power source. See section 0.
- Batteries. See section 3.4.
- Appropriate and reliable cable terminals, cable lugs, battery terminals and cord end terminals.
- For CZone setup, an RJ45-M12 Drop cable CZone/MB (included) and a tee connector (not included). When connecting several drop cables in a similar location, use a 2-way or 4-way tee connector
- For MasterBus setup, an RJ45 MasterBus cable (not included).

We recommend as a minimum tool kit:

- Socket wrench 13mm to fix the main DC cables.
- Socket wrench 10mm to fix the Safety ground connection.
- Flat blade screwdriver 1.0 × 4.0mm to fix the screw terminals of the AC wiring.
- Tools to fix the screws / bolts (Ø 6mm) with plugs to mount the ChargeMaster Plus to a surface.
- Philips screwdriver number 2 to open the connection compartment.

3.6 Overview of the connection compartment

Front side with open connection compartment

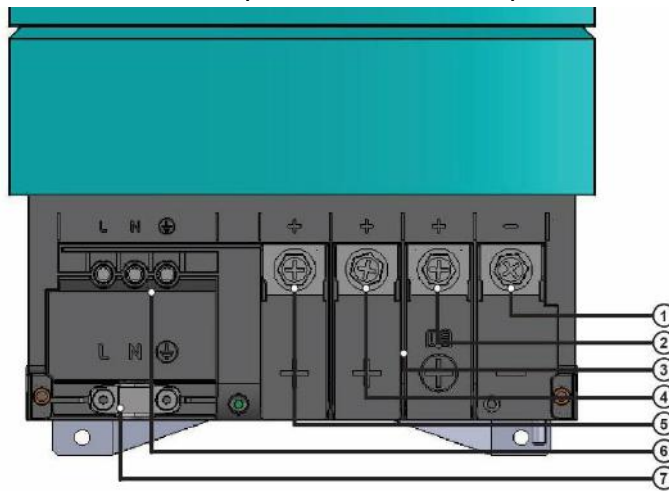

Bottom side

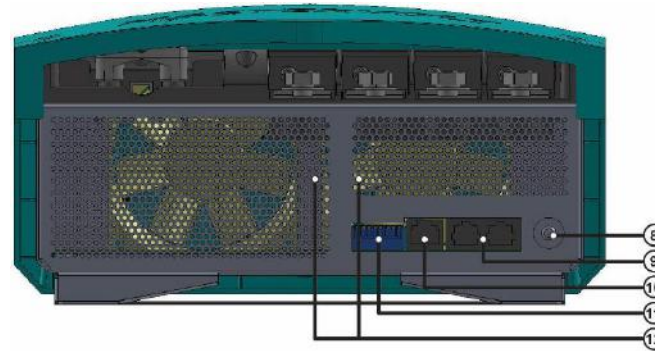

- | | |
|--|--|
| 1 Common negative output terminal | 7 Strain relief for AC wiring |
| 2 Positive terminal charge output 3; DC 3 IN/OUT | 8 Safety ground connection |
| 3 Isolation walls for DC connections | 9 Network connection (CZone/MasterBus) |
| 4 Positive terminal charge output 2; DC 2 OUT | 10 Temperature sensor connection |
| 5 Positive terminal charge output 1; DC 1 OUT | 11 DIP switches |
| 6 Screw terminals AC input | 12 Ventilation openings |

Figure 2: Connections

3.7 Connection example

This schematic illustrates the general placement of the ChargeMaster Plus in a circuit. It is not meant to provide detailed wiring instructions for any particular electrical installation.

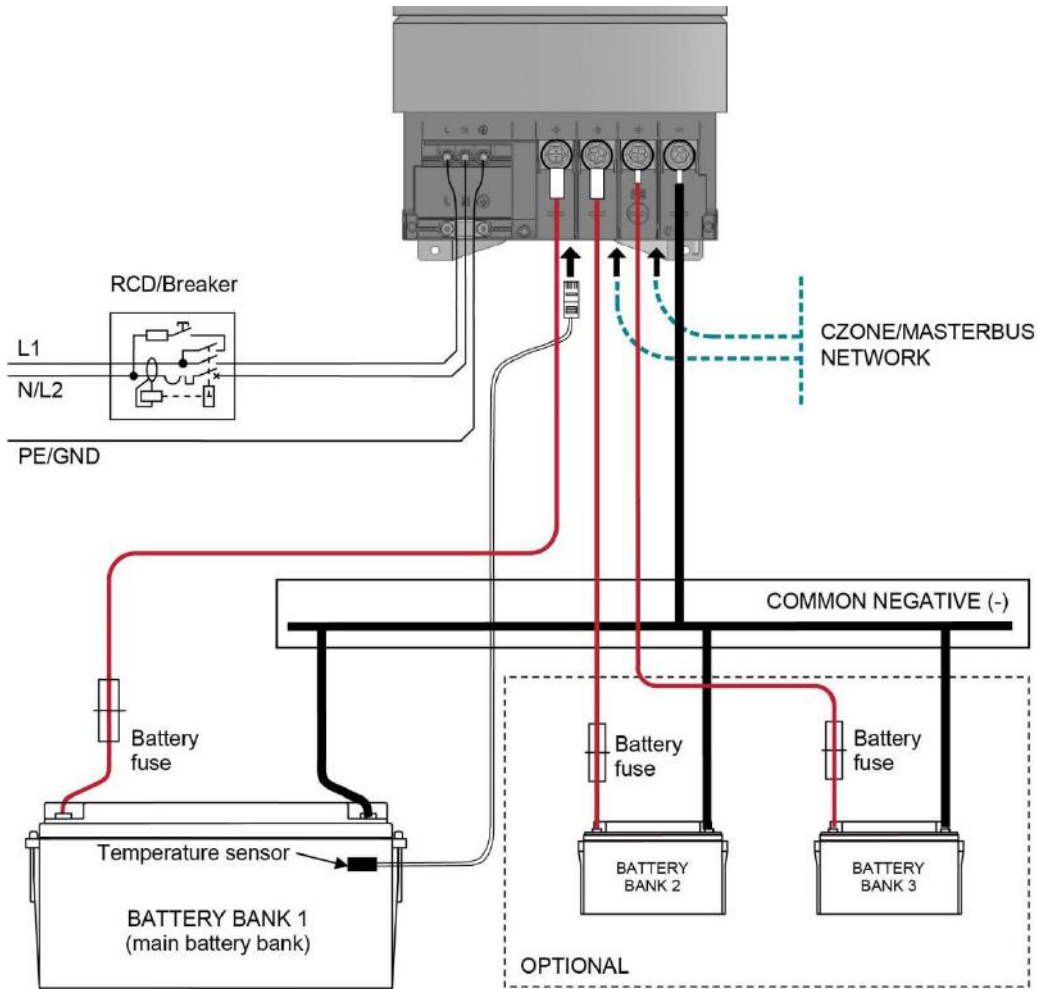

Figure 3: Installation drawing of the ChargeMaster Plus

Notes:

- If the battery temperature remains within 15-25°C, connection of the battery temperature sensor is optional.
- Lithium-ion batteries require no temperature sensor.
- If creating a parallel system of multiple ChargeMaster Plus units, the units should be excluded from any isolation measurement system.



WARNING!

All electrical systems (AC and DC) must be disconnected from any power source during the entire installation!



CAUTION!

Too-thin cables and/or loose connections can cause dangerous overheating of the cables and/or terminals. Therefore, tighten all connections well, in order to limit transition resistance as far as possible. Use cables of the correct size.



CAUTION!

Short circuiting or reversing polarity may lead to serious damage to the batteries, the ChargeMaster Plus, the cabling and/or the terminal connections. Fuses between the batteries and the ChargeMaster Plus cannot prevent damage caused by reversed polarity. The damage as a result of reverse polarity is detectable by the service department and is not covered by the warranty.

3.8 Installation step-by-step

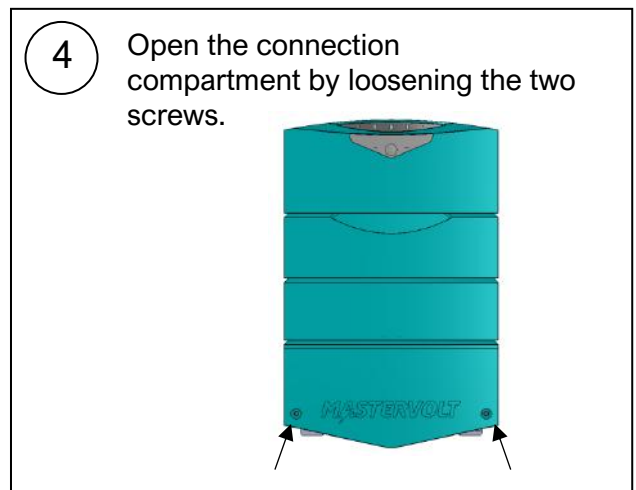
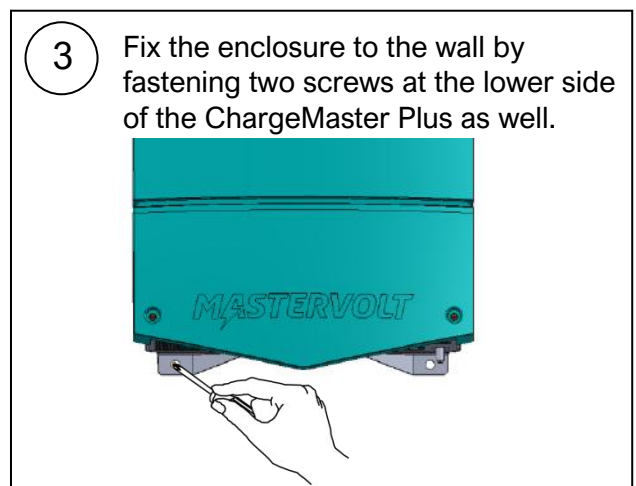
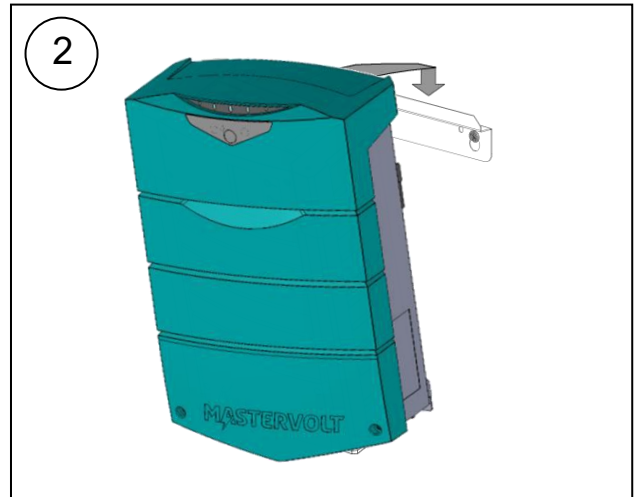
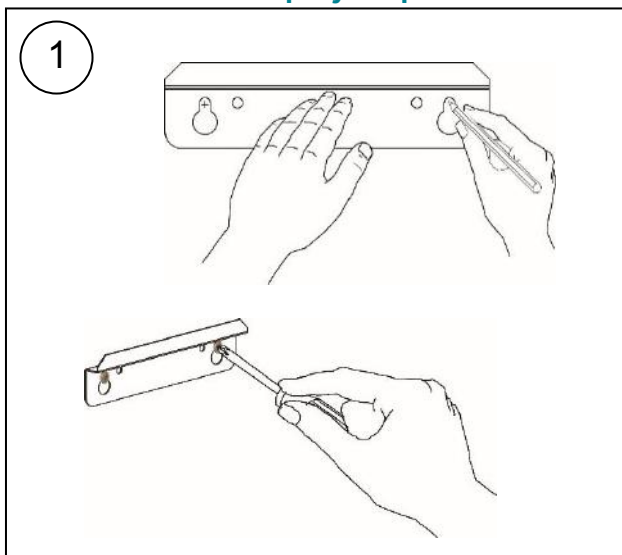

- 5 Connect the wiring to the screw terminals. Fasten the cable with the strain relief.

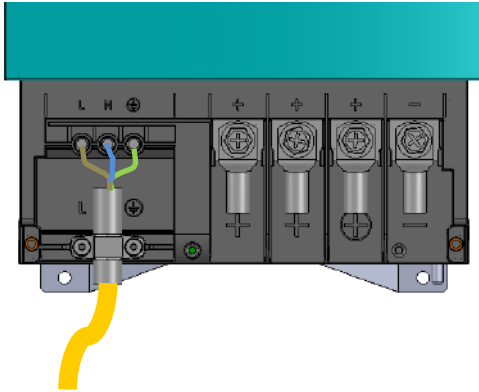

- 6 Integrate a fuse holder in the positive battery wire but do not place the fuse yet! Fit crimp-on cable lugs to the DC cables. Connect the DC cabling of battery bank 1, positive to +, negative to - .

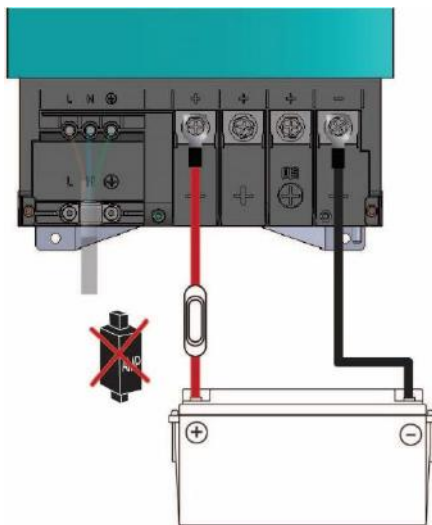

Repeat steps for output 2 and 3.

- 7 Attach the battery temperature sensor to the casing of battery bank 1. Plug the temperature sensor cable into the “Temp sense” jack.

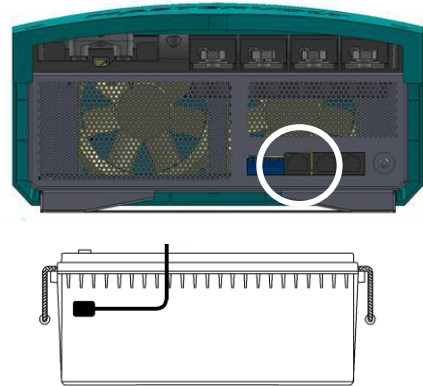

- 8 Option: Connect the ChargeMaster to the CZone or MasterBus network.

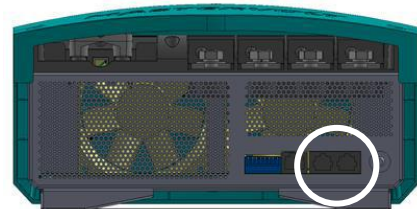

Adding to a CZone network

- 1 Disconnect the backbone at the closest backbone connection and add in a tee connector.
- 2 Reconnect the backbone connection(s) with the new tee connector in place.
- 3 Connect the RJ45 CZone/MB drop cable to the black coupler on the tee and then connect to the ChargeMaster Plus.

Adding to a MasterBus network

- 1 Disconnect a MasterBus cable or Terminator from the closest MasterBus device and connect it to the ChargeMaster Plus.
 - 2 Connect the new MasterBus cable to the other MasterBus device and then connect to the ChargeMaster Plus.
- Ensure that the network is properly terminated.

9

If required, use a small screwdriver to change DIP switch settings. See section 4.1.

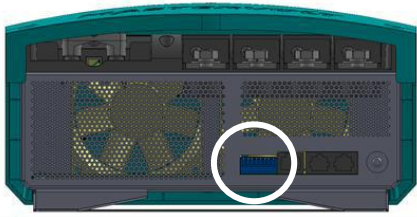

10

Check all wiring; see also Figure 3 for wiring details. If all wiring is OK: Place the DC fuses.

11

Close the connection compartment by fixing the screws.



12

Continue with section 3.9 for commissioning of the ChargeMaster Plus.

3.9 Commissioning after installation

- 1 **Check the wiring;** positive connected to positive (red cables), negative connected to negative (black cables).
- 2 When all wiring is OK, place the **DC fuse(s)** to connect the batteries to the ChargeMaster Plus.



WARNING!

When placing this fuse, a spark might occur, caused by the capacitors used in the ChargeMaster Plus. This is particularly dangerous in places with insufficient ventilation. Due to the gassing of the batteries, an explosion can occur. Avoid having flammable materials close by.

- 3 Switch on the **AC power** supply.
Note: when new, the ChargeMaster Plus will not start charging batteries before activated with the ON/OFF button. See step 6.
- 4 Check the **DIP switches**.
See chapter DIP switch settings on page 16.
- 5 Check and adjust the settings of the ChargeMaster Plus with **MasterAdjust** (MasterBus network) or with the **CZone Configuration Tool** (CZone network).
See chapter SETTINGS on page 16.
- 6 When the settings meet the power system's needs, press and hold the **ON/OFF** button for 3 seconds to switch the charger on and initiate the charging process.

4 SETTINGS

Adjustment of the settings of the ChargeMaster Plus can be made in two different ways:

- By means of DIP switches.
- From a laptop or notebook connected to the ChargeMaster Plus via a USB Interface. Some settings can only be changed in this way.



CAUTION!

Invalid settings of the ChargeMaster Plus can cause serious damage to your batteries and/or the connected load! Only authorized personnel may adjust settings.

When required, the ChargeMaster Plus can be restored to factory settings (see section 0).

4.1 DIP switch settings

Use a small screwdriver to carefully set the required settings.



Figure 4: DIP switches (factory settings)

DIP switch 1 = CZone (0↑) or MasterBus (1↓) network.

DIP switch 2 = MasterBus powering off (0↑) or on (1↓)

DIP switches 3 to 10 are either used as CZone address or for MasterBus battery and 3rd output settings.

In a CZone network:

DIP switch 1 must always be set to the OFF position (0).

DIP switch 2 must always be set to the OFF position (0).

DIP switches 3 to 10 must match the unique address used in the CZone network; the dipswitch. See the *CZone Configuration Tool Instructions* manual for more information.

In a MasterBus network:

DIP switch 1 must always be set to the ON position (1).

DIP switch 2 is MasterBus Powering ON (1) or OFF (0).

DIP switches 3 to 5 are used for battery type selection:

DIP switch	3	4	5
MasterBus settings (Flooded) ¹	0	0	0
Flooded (fixed)	0	0	1
AGM (fixed)	0	1	0
Gel (fixed)	0	1	1
Lithium-ion (fixed)	1	0	0
Constant voltage (13,25/26,50V) ²	1	1	1

¹ If all DIP switches are in the OFF position (0 ↑), the settings suit a Flooded battery but can be changed in MasterAdjust.

² Constant voltage has no temperature compensation

DIP switches 6 and 7 are used for DC 3 IN/OUT:

DIP switch	6	7
12V battery	1	
Current limit 10A	1	

These two options cover the most used applications. Other options can be selected via the configuration tool.

See section 5.4 for more information on charge voltage settings and section 0 for DC 3 IN/OUT.

4.2 MasterBus configuration

MasterBus is a CAN based data network for communication between Mastervolt devices. When the ChargeMaster Plus is connected, open MasterAdjust on a Windows laptop or notebook connected to the MasterBus network via a MasterBus USB interface. MasterAdjust software is available as free to download software on the Mastervolt website: www.mastervolt.com. This tool runs on a Windows laptop or notebook.

4.2.1 Monitoring

A remote panel, like the SmartRemote, Touch 5 (CZone) or EasyView 5 (MasterBus), can be used for reading battery information. See applicable user manuals for details. The following table lists the parameters as shown in MasterAdjust.

Parameter	Meaning	Value range
General		
Device state	Shows charger state (On / Stand-by / Alarm / Off)	(read only)
Charger state	Actual state of charge process: Off/bulk/absorption/float/suspended	(read only)
'Toggle' button	Button to toggle the charger state. This button does not work when the ChargeMaster Plus is switched off manually. In that case it can only be switched on with the ON/OFF button.	On / off
Input current	Option to set the maximum AC input current level to prevent a generator or shore fuse from overload. See section 4.2.6 for more information. Default 20.	0-20A
AC present*	Shows the presence of AC input	(read only)
Battery temp.*	Temperature of the main battery bank (in °C)	(read only)
DC 1 OUT		
Output 1*	Output state (Off/pre-float/on)	(read only)
Output 1 V	Voltage of charge output 1	(read only)
Output 1 A	Output current of charge output 1	(read only)
Shunt device	A connected MasterShunt can be chosen for feedback on the charged battery. Default not selected.	(read only)
DC 2 OUT		
Output 2*	Output state (Off/pre-float/on)	(read only)
Output 2 V	Voltage of charge output 2	(read only)
Output 2 A	Output current of charge output 2	(read only)
DC 3 IN/OUT		
Output 3*	Output state (Off/pre-float/on/smart input DC 3 IN/OUT)	(read only)
Output 3 V	Voltage of charge output 3	(read only)
Output 3 A	Output current of charge output 3	(read only)

* Parameters marked with a * are not available in CZone.

4.2.2 Alarms

The following table lists the available alarms in MasterAdjust.

Parameter	Meaning
Alarm status	
Bat. temp. error	Battery temperature too high / too low
TS error	Temperature sensor error
DC 1 OUT	
Shunt mismatch	Setting for nominal voltage (12/24V) at the MasterShunt or the nominal voltage of the MLI batteries differs from nominal voltage detected by the ChargeMaster Plus. Check battery voltage and settings of the MasterShunt or voltage of the MLI Ultra battery.
Reverse polarity	DC + and DC –are connected in reverse (this will damage the charger)
DC 2 OUT	
Reverse polarity	DC + and DC –are connected in reverse (this will damage the charger)
DC 3 IN/OUT	
Reverse polarity	DC + and DC –are connected in reverse (this will damage the charger)

4.2.3 History

The history data shows the absolute maximum readings. The following parameters are only shown in MasterAdjust.

Parameter	Meaning
Charger	
Days running	Total run time in charger mode
DC 1 / 2 OUT	
Total Ah's	Total charged Ah's
DC 3 IN/OUT	
Total Ah's	Total charged Ah's
Total Ah's in	Total charged Ah's using DC 3 IN/OUT as input

4.2.4 Configuration settings

The configuration can be done in MasterAdjust, from a laptop or notebook connected to the ChargeMaster Plus via a Mastervolt USB Interface. See applicable user manuals for details. The following table lists the parameters as shown in MasterAdjust.

- Notes:**
- DIP switch settings overrule MasterBus settings. If DIP switches are not in their default setting, the corresponding MasterBus setting is grayed out.
 - To be able to make changes to the configuration via MasterBus, DIP switch 1 must be in the ON position.

Parameter	Meaning	Factory setting	Value range
Device			
Language*	Menu language of this device	English	EN, NL, DE, FR, ES, IT, NO, SV, FI, DA
Name	Name of this device. This name will be recognized by all devices connected to the network	CHG ChargeMaster	0-12 characters
Powersave mode*	If Powersave mode is ON, the charger will switch itself off when no AC power is available. If Powersave mode is OFF, the charger stays ON even when no AC power is available.	On	On, Off
Charger			
Method	Charge method	3-Step+	3-Step+, constant voltage
Maximum current	Maximum DC output current	Depending on model, 100%	Depending on model 20-100%
Battery type	Type of battery	Flooded	User defined, AGM, Gel, Flooded, Lithium-ion
Temp. compensate	Temperature depended charge voltage compensation	-0,030V/°C / -0,060V/°C	-1,000/+1,000V/°C
DC 3 IN/OUT	Charge method DC 3 IN/OUT	Follow DC 1	Current limit, Current limit+A, Follow DC 1, Follow DC1 + Alt, Constant 12V, Constant 24V*, 12V 3-Step+*, 12V Battery*
Full Current	Select if 3 rd output is a full output	On	On, off
Maximum current	DC 3 IN/OUT maximum DC output current	40/20A	5-40/20A
Input threshold	Voltage threshold used to switch over when DC 3 IN/OUT acts as VSR	13,75/27.50V	8-16/16-32V
Input current	DC 3 IN/OUT maximum DC input current (see also section 4.2.6)	40/20A	5-40/20A

Parameter	Meaning	Factory setting	Value range
Bulk			
Voltage	Bulk voltage (@ 25°C); see section 5.4	14.40/28.80V	8-16/16-32V
Minimum time	Minimum time of the Bulk phase since <i>Start bulk timer</i>	120sec	0-240sec
Start time at	Battery voltage trigger point to start the bulk timer	13.25/26.50V	(read only)
Maximum time	Maximum time of the Bulk phase since <i>Start bulk timer</i>	480 min	0-1440min
Absorption			
Voltage	Absorption voltage (@ 25°C); see section 5.4	14.25/28.50V	8-16/16-32V
Maximum time	Maximum absorption timer	240min	0-1440min
Return Amps	Return amps. If the charge current drops below this level, the charger switches from the Absorption to the Float stage (% of I_{max})	6%	0-50%
Minimum time	Minimum absorption timer	15min	0-240min
Float			
Voltage	Float voltage (@ 25°C); see section 5.4	13.25/26.50V	8-16/16-32V
Return to bulk V	Return to bulk voltage; If the battery voltage stays below this level for at least the <i>Return to bulk delay time</i> , the charger will start the Bulk stage	12.80/25.60V	8-16/16-32V
Return to bulk sec	Return to bulk delay time, see <i>Return to bulk voltage</i>	30sec	0-240sec
DC 1 OUT			
Name	Name of this output	Output 1	0-16 chars
Shunt device	Selection of the MasterShunt to which output 1 of the ChargeMaster Plus is connected	Not selected	Not selected, MSH + Product Name
DC 2 OUT			
Name	Name of this output	Output 2	0-16 chars
DC 3 IN/OUT			
Name	Name of this output	Output 3	0-16 chars
Installer menu			
DIP Switch	DIP switch settings	1100000000	0 / 1
Factory settings button*	Button to reset the ChargeMaster Plus to default settings (requires installer rights)	<i>Not applicable</i>	<i>Not applicable</i>

*24V models only

* Parameters marked with a * are not available in CZone.

4.2.5 Events – System automation

A CZone/MasterBus device can be programmed to initiate an action at another connected device. This is very helpful in automation of your system but is not required.

In MasterBus this is done by means of event-based commands. In the Events tab you can program the ChargeMaster Plus to act as an event source. Events which occur during the operation of the ChargeMaster Plus will then trigger actions from other products. The following tables list the parameters as shown in MasterAdjust.

Field	Meaning	Value
Event x source	Select an event that triggers an action, for example Battery pre low.	See <i>Event source</i> list
Event x target	Select the device that should act, for example the generator	Selectable targets are system dependent
Event x command	Select the parameter that must be changed on the target device, for example Activate.	See command list of the selected device
Event x data	Data, for example On, is linked to the command.	Off, On, Copy, Copy Invert, Toggle

Table 1: MasterBus event parameters

The ChargeMaster Plus can be configured as an *event source*. An event source can be used to initiate an *event command* and an *event action* by another device.

Event source	Meaning
Charger state	State of the ChargeMaster Plus serves as an event source
Bulk	Bulk state of charge serves as an event source
Abs	Absorption state of charge serves as an event source
Float	Float state of charge serves as an event source
Failure	Any fault condition of the ChargeMaster Plus serves as an event source

Table 2: ChargeMaster Plus MasterBus Event sources

When the ChargeMaster Plus is configured as an *event target* by another device, this device can initiate an *event command* and an *event action* to be performed by the ChargeMaster Plus.

Event command	Meaning
On	Command to switch on the ChargeMaster Plus
Bulk	Command to start the Bulk state of charge
Abs	Command to start the Absorption state of charge
Float	Command to start the Float state of charge
Suspend charging	When using a MLI Ultra Li-ion battery, this event is obligatory. Refer to the MLI Ultra manual.

Table 3: ChargeMaster Plus MasterBus Event commands

4.2.6 Current control

If the available power at the AC input is limited. The ChargeMaster can be configured to reduce input current. The Current Control level should be set equal to or lower than the value of the external circuit breaker, which protects the incoming AC power. For example, when the external AC power is limited by a 6A fuse, the Current Control level should be set to $\leq 6A$. The AC input current of the ChargeMaster Plus will be reduced to 6A.

How to set the DC input current in a MasterBus network

1. Open MasterAdjust.
2. Select the ChargeMaster Plus.
3. Go to the **Monitoring** tab.
4. In the **Input Current** field, enter the required value.

4.3 MasterShunt

In a MasterBus network, a MasterShunt can be coupled with output 1 (DC 1 OUT) of the ChargeMaster Plus. The actual measurement data of the MasterShunt will be used to charge the batteries. Refer to the manual of the MasterShunt for information on how to configure your system.

4.4 Li-ion Battery MLI Ultra

The ChargeMaster Plus can be combined with a Li-ion battery MLI Ultra. Refer to the manual of the Li-ion battery MLI Ultra for information on how to configure your system.



WARNING!

Before using the Li-ion battery, it must be properly installed and commissioned!

4.5 CZone configuration

The CZone® network is an NMEA 2000-compliant CAN-based system. When the ChargeMaster Plus is connected, open the CZone Configuration Tool on a Windows laptop or notebook connected to the CZone network. Either do the configuration while connected to the network or use a prepared configuration file (.zcf). Ensure that a DIP Switch is assigned. Also see section 0 for a detailed description of the same settings in MasterAdjust.

Adding the ChargeMaster Plus to a CZone system configuration

Precondition: This section assumes that a CZone system is already configured and the CZone Configuration Tool is open.

In the CZone Configuration Tool, from the Modules tab, press the **Add** button.

From the **Module Type** drop-down list select **Chargers**.

From the **Charge Type** drop-down list select the required model and continue with the following steps.

1. Enter an understandable **Module Name**.
2. Each device on a CZone network has a unique CZone address; the **Dipswitch**. This number must match the physical DIP switch settings. When connected to the system: either select one from the drop-down list or edit graphically.
3. Select the **Battery Type**.
4. Enter the **DC Current Limit**.
5. Option: press the **Advanced Settings** button to configure advanced options.

6. Select the required **Charge Method** from the drop-down list.
7. Enter an understandable **Name** for **DC 1 OUT**, **DC 2 OUT** and **DC 3 IN/OUT**.
8. From the **DC 3 Charge Method** drop-down list, select the required charge method for DC 3 IN/OUT. See section 0. Depending on the selected charge method, additional settings will be offered, hidden or grayed out.

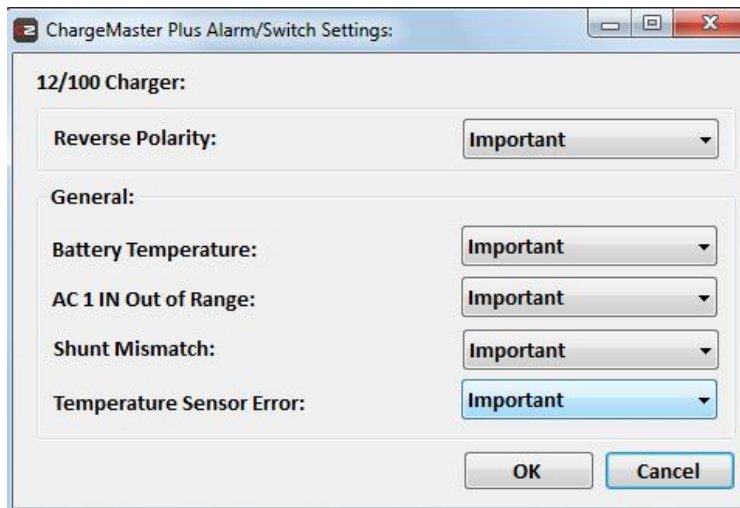

9. **NMEA2000 Instances** are used to differentiate between multiple monitoring sources.
10. Press **OK** to return to the Module Modification window and press the **Alarm/Switch Settings** button.
11. Select the required Alarm Severities.
12. Press **OK**.

Optionally configure digital switching by adding Circuit Controls in the Circuits tab (e.g. a battery low switch can be used to start a generator). Write the configuration to the network to use the new configuration.



For more information, please refer to the CZone® Configuration Tool Instruction manual.

5 OPERATING INSTRUCTIONS

5.1 Introduction

The Mastervolt ChargeMaster Plus is a fully automatic battery charger. This means that under normal circumstances it can be left switched on with AC power and batteries connected. The ChargeMaster Plus is suitable for charging of Li-ion and lead-acid batteries, which may include maintenance-free, low maintenance, AGM, gel or deep-cycle batteries. It operates on both 240V and 120V.



WARNING!

The MLI charging voltages on this charger fit the Mastervolt Li-ion (MLI) batteries but do not necessarily fit other Li-ion batteries! Always follow the instructions provided by the battery manufacturer!

5.2 Switching on / off

The ChargeMaster Plus is activated by keeping the **ON/OFF** button pressed for approximately 3 seconds. The **MODE** LED will illuminate green. If necessary and if AC power is available, the ChargeMaster Plus will start to charge the batteries.

Note: Once switched on, the ChargeMaster Plus automatically resumes operation after it was disconnected from an AC source temporarily.

By holding the **ON/OFF** button pressed again for approx. 3 seconds, the ChargeMaster Plus will switch off: the ChargeMaster Plus stops and the **MODE** LED illuminates red. When the ChargeMaster Plus was switched off, it can only be activated by pressing the **ON/OFF** button again.



WARNING!

Switching the ChargeMaster Plus off or “stand-by” does not cut off the connection to the batteries or the AC source. This means that voltages are still present inside the apparatus.

5.3 Status display

The status display at the front side of the ChargeMaster Plus enables you to control the charger and monitor the charging process.

Note: The ChargeMaster Plus can also be monitored from a remote panel like the Touch 5 (in a CZone network) or the EasyView 5 (in a MasterBus network). See section 04.2 for details.

The status display has a 3 level menu. Menu navigation is done by shortly pressing the **ON/OFF** button. After each press the next menu level is shown. The color of LED 1 indicates the level that is being shown.

Color LED 1	Menu	Meaning
Green	Level 1	Status menu
Orange	Level 2	Output power menu
Red	Level 3	Error menu

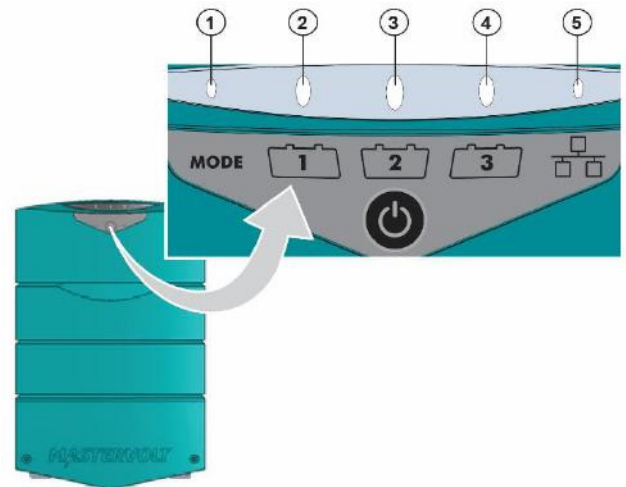

Figure 5: ChargeMaster Plus status LEDs

STATUS MENU		
LED	State	Meaning
1	Solid green	ChargeMaster Plus on
	Solid red	ChargeMaster Plus stand-by
	Blink fast red	Error, navigate to error menu
2	Blinking fast green	Battery in bulk stage
	Blinking slow green	Battery absorption stage
	Solid green	Battery in float stage

	Blinking fast green	Battery in bulk stage
3	Blinking slow green	Battery absorption stage
	Solid green	Battery in float stage
4	Blinking fast green	Battery in bulk stage
	Blinking slow green	Battery absorption stage
	Solid green	Battery in float stage
5	Blinking green	Network communication

OUTPUT POWER MENU

LED	State	Meaning
1	Solid orange	Output power menu
2	Solid orange	Total output power 0-25%
3	Solid orange	Total output power 26-50%
4	Solid orange	Total output power 51-75%
5	Solid orange	Total output power 76-100%

ERROR MENU

LED	State	Meaning	What to do
1	Blink fast red	Error menu	
2	Blink fast red	Reverse polarity	Check battery connection
3	Blink fast red	AC error	Check AC voltage/frequency
4	Blink fast red	DC error	Check battery voltage
5	Blink fast red	Temperature sense error	Check temperature sensor

5.4 The 3-step+ charge process

Battery charging is accomplished in three automatic stages: BULK, ABSORPTION and FLOAT. The first step is the BULK phase, in which the output current of the charger is 100%, and the greater part of the capacity of the battery is rapidly charged. The current charges the batteries and gradually the voltage rises to the

BULK voltage 14.25V respectively 28.5V at 25°C/77°F.

The duration of this phase depends on the ratio of battery to charger capacity, and the battery state of charge.

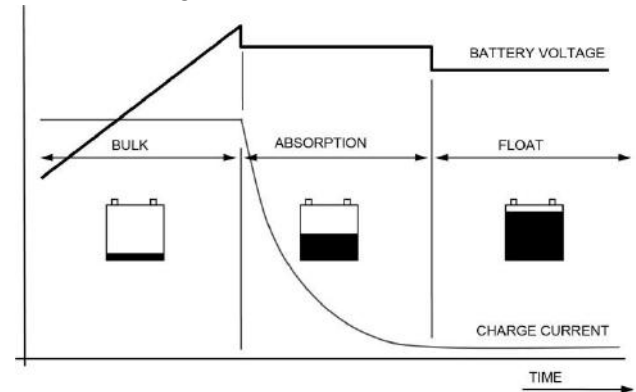

Figure 6: charge process

The BULK phase is followed by the ABSORPTION phase. Absorption charging starts when the voltage on the batteries has reached the BULK voltage, and ends when the battery is completely full. Battery voltage remains constant at 14.25V/28.5V at 25°C/77°F throughout this stage, and the charge current depends on the degree to which the battery was initially discharged, the battery type, the ambient temperature, etc. With a flooded battery this stage lasts approx. 4h, with gel and AGM around 3h. Once the battery is 100% full, the ChargeMaster Plus automatically switches over to the FLOAT phase. In FLOAT, the ChargeMaster Plus switches to a stabilized 13.25V/26.5V (Flooded), 13.8V/27.6V (Gel/AGM) or 13.5V/27V (MLI) at 25°C/77°F.

Connected DC loads are powered directly by the charger. If the load exceeds the charger capacity, the required additional power comes from the battery, which will be progressively discharged until the charger automatically switches back to the bulk phase. Once consumption decreases, the charger goes back to normal operation of the 3-step charge system.

As the ChargeMaster Plus is equipped with a 3-step+ charge system, the batteries can also remain connected to the ChargeMaster Plus during winter. One hour every 14 days the charger automatically switches to absorption to keep the battery running properly and prolong its life span. The three-step plus charge system is also safe for all the connected equipment. See also Figure 9 on page 35.

5.4.1 Charge voltages

	Bulk	Absorption	Float
AGM or GEL	14.25 / 28.5	14.25 / 28.5	13.80 / 27.6
Flooded	14.25 / 28.5	14.25 / 28.5	13.25 / 26.5
Lithium-ion	14.25 / 28.5	14.25 / 28.5	13.50 / 27.0

5.4.2 Pre-float

The ChargeMaster Plus can automatically switch each individual output from absorption to pre-float stage. Pre-float ensures batteries that are nearly full don't receive the higher charge voltage needed in the absorption stage. This prevents over-charging, extending the lifespan of the batteries.

5.4.3 Temperature compensated charging

By installing the battery temperature sensor, the charge voltages are automatically adapted for deviating temperatures.

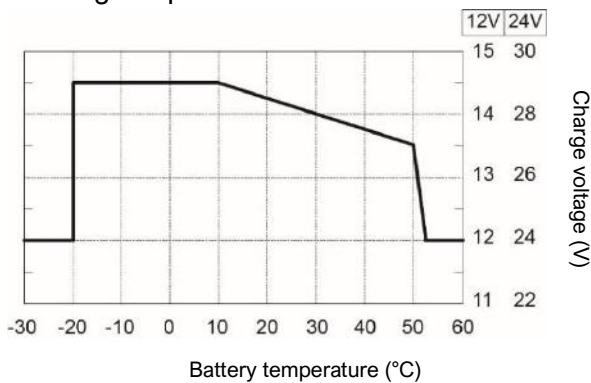

Figure 7: Temperature compensated charging

When the battery temperature is low, the charge voltage increases. On the other hand, when the battery temperature is high, the charge voltage is decreased. Overcharge and gassing are prevented this way. This will extend the life of your batteries.

5.4.4 Flat battery support

The ChargeMaster Plus automatically detects a flat battery and will initiate the flat battery charge curve described in the following table.

UBat	Voltage	Output power
12V	0.00V – 2.50V	15%-30% of I_{max}
24V	0.00V – 5.00V	
12V	2.50V – 8.00V	25% of I_{max}
24V	5.00V – 16.00V	
12V	8.00V – 10.00V	linear from 25% - 100% of I_{max}
24V	16.00V – 20.00V	
12V	10.00V – 14.25V	100% of I_{max}
24V	20.00V – 28.50V	
12V	>14.25	Limited by P_{max}
24V	>28.50	

5.5 DC 3 IN/OUT

The ChargeMaster Plus is equipped with three outputs; DC 1 OUT, DC 2 OUT and DC 3 IN/OUT. The total output current is divided over these three outputs. See section 3.6 for connections.

DC 3 IN/OUT can be current limited and can serve as an output and as an input to charge batteries 1 & 2. DC 3 IN/OUT can operate in the following operating modes:

- **12V Battery** (DIP switch 6) (*24V models only*)

If DIP switch 6 is in the on position, then DC 3 IN/OUT is set to 12V. All batteries are charged with the same settings. DIP switch 6 has no effect on a 12V charger. In case of a 24V charger, DC 3 IN/OUT is current limited (configurable).

- **Current limit 10A** (DIP switch 7)

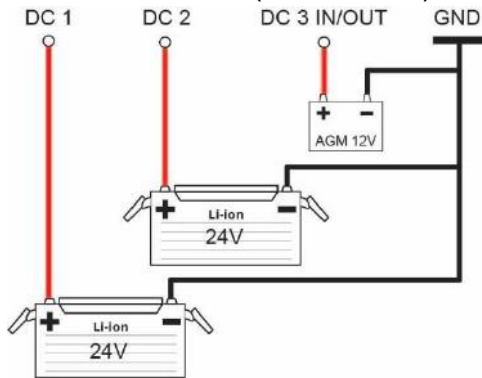

If DIP switch 7 is in the on position, then DC 3 IN/OUT is current limited to 10A to safely charge a small starter battery. When a 24V charger is used, DIP switch 6 can also be in the on position, unless the 24V charger must charge a 24V starter battery.

- **Follow DC 1**

All batteries are charged with the same settings; a 12V charger with 12V and a 24V charger with 24V.

- **Follow DC 1 + Alternator**

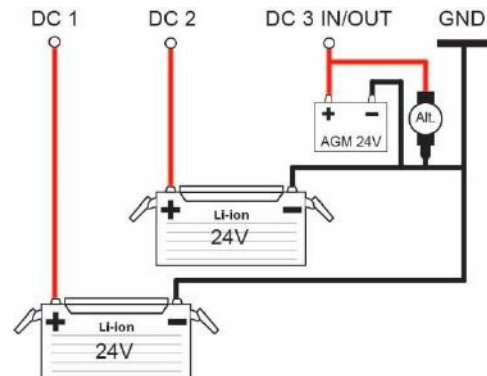

Three full outputs. All batteries are charged with the same settings. DC 3 IN/OUT acts as a VSR (Voltage Sensitive Relay). When there is no AC power available and the alternator is charging the starter battery, the alternator can also be used to charge batteries 1 & 2. The threshold voltage which is used to switch over is set via the configuration tool.

- **Constant 12V**

DC 3 IN/OUT is current limited (configurable) and set to 13,25V constant voltage.

- **Constant 24V** (*24V models only*)

DC 3 IN/OUT is current limited (configurable) and set to 26,5V constant voltage.

- **12V 3-Step+** (*24V models only*)

DC 3 IN/OUT can charge a 12V battery with its own charging profile. Settings can be configured.

The charge method can be selected in the configuration tool. The first two can also be selected via DIP switches.

5.6 Maintenance

No specific maintenance to the ChargeMaster Plus is required. Examine your electrical installation on a regular basis, at least once a year. Defects such as loose connections, damaged wiring etc. must be corrected immediately. If necessary, use a soft clean cloth to clean enclosure of the ChargeMaster Plus. Do not use any liquids or corrosive substances, such as solvents, alcohol, petrol or abrasive components.

5.7 Storage

If it is necessary to put the ChargeMaster Plus out of operation, execute the following steps:

- 1 Turn AC power off.
- 2 Switch off the ChargeMaster Plus (see section 5.2).
- 3 Remove the DC fuse(s) and disconnect the batteries.
- 4 Switch the RCD/Breaker of the AC input to the OFF position and, if required, disconnect the AC mains.
- 5 Open the connection compartment of the ChargeMaster Plus.
- 6 Check with a suitable voltage meter whether the inputs and the outputs of the ChargeMaster Plus are voltage free.
- 7 Disconnect all the wiring.

Now the ChargeMaster Plus can be demounted in a safe way. When not installed, store the ChargeMaster Plus in a dry and dust free environment. To return to normal operation, after re-installation, switch on the AC.

6 TROUBLE SHOOTING

The ChargeMaster Plus is protected against overload, short circuit, overheating and under and over voltage. If a fault condition occurs, the LEDs indicate an error code. See section *Status display* for an explanation.



CAUTION!

The ChargeMaster Plus is not protected against serious over voltage (>275VAC) on the AC input.

If you cannot solve a problem using the fault-finding table, contact your supplier or Mastervolt. Make sure you have the part and serial number at hand.

Malfunction	Possible cause	What to do
No output voltage and/or current	No AC input	Check AC wiring, check remote control panel
	AC input voltage too low (< 75VAC)	Check input voltage, check generator
	AC input frequency out of range	Check input voltage, check generator
Output voltage too low, charger supplies maximum current	Load connected to the batteries is larger than charger can supply	Reduce load taken from the batteries
	Batteries not 100% charged	Measure battery voltage. After some time this will be higher
	Wrong setting of the charge voltage	Check settings (see chapter 4)
Charge current too low	Batteries almost fully charged	Nothing, this is normal when the battery is almost fully charged
	High ambient temperature	Nothing; if ambient temperature is more than the setting limit, the charge current is automatically reduced
	Low AC input voltage. At lower AC input voltages, the charge current is reduced	Check AC input voltage
Batteries not fully charged	Charge current too low	See "Charge current too low" in this table
	Current to load is too high	Reduce load taken from the batteries
	Charge time too short	Use a battery charger with higher capacity
	Battery temperature too low	Use the battery temperature sensor
	Defective or old battery	Check battery and replace if necessary
	Wrong setting of the charge voltage	Check settings (see chapter 4)

Malfunction	Possible cause	What to do
Batteries are discharged too fast	Battery capacity reduced due to wastage or sulphation, stagnation	Charge and recharge a few times, this might help. Check battery and replace if necessary
Batteries are too warm, gassing	Defective battery (short circuit in cell)	Check battery and replace if necessary
	Battery temperature too high	Use the battery temperature sensor
	Charge voltage too high	Check settings (see chapter 4)
Remote panel display shows no ChargeMaster Plus	Display is switched off	Switch on display, refer to display manual
	Error in the wiring	Check the network cables
	No terminating device placed at the ends of the network	A network needs a terminating device on both ends of the network, check if available
	Network is configured as a ring network	Ring networks are not allowed. Check the connections of the network.
	ChargeMaster Plus is not configured in CZone configuration file	Open CZone Configuration Tool and check.
	ChargeMaster Plus Dipswitch not correct	Open CZone Configuration Tool and check with Force Dipswitch for Address.
Slow or no MasterBus communication.	Error in the MasterBus wiring	Check the network cables
	No MasterBus Terminator placed at the ends of the network	MasterBus needs a terminating device on both ends of the network. Check if connected
	MasterBus network is configured as a ring network or there are T-connections	Ring networks and T-connections are not allowed. Check the connections of the network

7 TECHNICAL DATA

7.1 Specifications 12V models

Model	12/75-3	12/100-3
Product code	44310755	44311005
Nominal input voltage	120/240V	120/240V
Nominal input frequency	50/60Hz	50/60Hz
Full load consumption	1300VA	1700VA
Max. AC input current (@ 240VAC)	5.6A	7.5A
Max. AC input current (@ 120VAC)	11.8A	14.9A
Nominal output voltage	14.25V	14.25V
Total charge current*	75A at 14.25V	100A at 14.25V
Number of battery outlets	3	3
Max. current DC 3 IN/OUT	75A/40A	100A/40A
Max. input voltage DC 3 IN/OUT	16V	16V
Charge characteristic*	IUoUo, automatic, 3-step+	
Charge voltage Bulk*	14.4V	14.4V
Charge voltage Absorption*	14.25V	14.25V
Charge voltage Float*;	13.25V	13.25V
Max. absorption and max. bulk timer*	8 hours (start max. bulk timer at 13.25V)	
Minimum absorption time*	15 min.	15 min.
Maximum ripple voltage on DC	120mV pp	120mV pp
Battery type settings*	Flooded (default), GEL, AGM, MLI (Li-ion), Constant voltage (13,25 V)	
Dimensions (mm)	383×250×126	383×250×126
Dimensions (inch)	15.0×9.8×5.0	15.0×9.8×5.0
Weight	5,9 kg (13 lbs)	5,9 kg (13 lbs)
Recommended battery capacity	140-800Ah	200-1000Ah
Power factor regulations	≥ 0,98	≥ 0,98
Temperature compensation	Battery temperature sensor and cable included.	
Voltage compensation	Yes, by means of automatic compensation or MasterShunt	
DC consumption	<5mA	<5mA
Temperature range	-25°C (-13°F) to 80°C (176°F) Derating 1%/°C (0,5%/°F) from 40°C (104°F) to 60°C (140°F) Derating 8%/°C (4,4%/°F) from 60°C (140°F) to 70°C (158°F) Communication available, 0% output power from 70°C (158°F) to 80°C (176°F)	
Cooling	Vario fan and natural cooling to ensure optimized cooling	
Sound level	<52dBA / 1m	
Protection degree	IP 23	IP 23
CZone connectivity	Yes	Yes
MasterBus connectivity	Yes	Yes
Powering capabilities for MasterBus	Yes, when the charger is switched on and AC is available, it can power up to three non-powering devices.	
Ignition protected	Yes, conforming to SAE J1171/ISO 8846	

* Adjustable, see chapter 4 for settings. Specifications are subject to change without prior notice.

7.2 Specifications 24V models

Model	24/40-3	24/60-3
Product code	44320405	44320605
Nominal input voltage	120/240V	120/240V
Nominal input frequency	50/60Hz	50/60Hz
Full load consumption	1400VA	2000VA
Max. AC input current (@ 230VAC)	7.1A	10.1A
Max. AC input current (@ 120VAC)	12.8A	18.7A
Nominal output voltage	28.5V	28.5V
Total charge current*	40A at 28.5V	60A at 28.5V
Number of battery outlets	3	3
Max. current DC 3 IN/OUT	40A/20A/10A(12V)	60A/20A/10A(12V)
Max. input voltage DC 3 IN/OUT	32V	32V
Charge characteristic*	IUoUo, automatic, 3-step+	
Charge voltage Bulk*	28.8V	28.8V
Charge voltage Absorption*	28.5V	28.5V
Charge voltage Float*;	26.5V	26.5V
Max. absorption and max. bulk timer*	8 hours (start max. bulk timer at 26.5V)	
Minimum absorption time*	15 min.	15 min.
Maximum ripple voltage on DC	240mV pp	240mV pp
Battery type settings*	Flooded (default), GEL, AGM, MLI (Li-ion), Constant voltage (13,25 V)	
Dimensions (mm)	383×250×126	383×250×126
Dimensions (inch)	15.0×9.8×5.0	15.0×9.8×5.0
Weight	5,9 kg (13 lbs)	5,9 kg (13 lbs)
Recommended battery capacity	160-400Ah	200-500Ah
Power factor regulations	≥0,98	≥ 0,98
Temperature compensation	Battery temperature sensor and cable included.	
Voltage compensation	Yes, by means of automatic compensation or MasterShunt	
DC consumption	<10mA	<10mA
Temperature range	-25°C (-13°F) to 80°C (176°F) Derating 1%/°C (0,5%/°F) from 40°C (104°F) to 60°C (140°F) Derating 8%/°C (4,4%/°F) from 60°C (140°F) to 70°C (158°F) Communication available, 0% output power from 70°C (158°F) to 80°C (176°F)	
Cooling	Vario fan and natural cooling to ensure optimized cooling	
Sound level	<52dBA / 1m	
Protection degree	IP 23	IP 23
CZone connectivity	Yes	Yes
MasterBus connectivity	Yes	Yes
Powering capabilities for MasterBus	Yes, when the charger is switched on and AC is available, it can power up to three non-powering devices.	
Ignition protected	Yes, conforming to SAE J1171/ISO 8846	

* Adjustable, see chapter 4 for settings. Specifications are subject to change without prior notice.

7.3 Dimensions

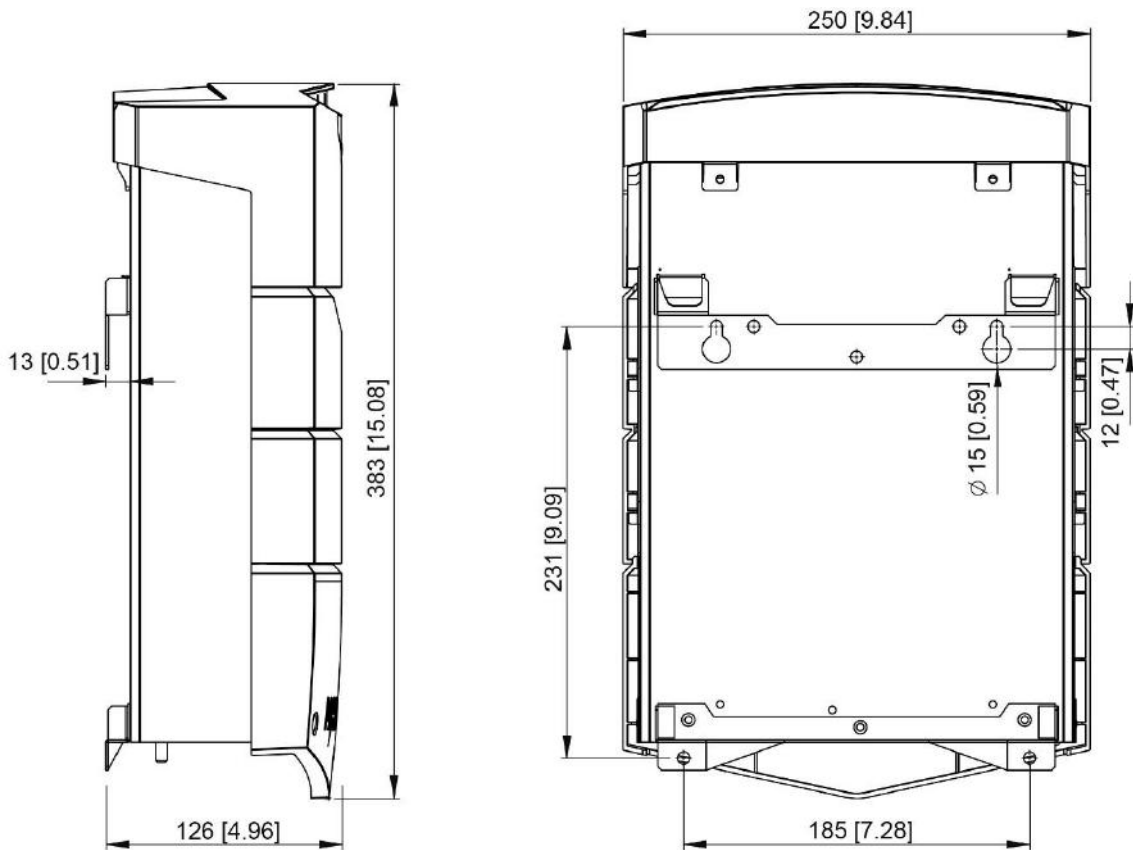

Dimensions in mm [inches] ChargeMaster Plus models 12/75-3, 12/100-3, 24/40-3 and 24/60-3.

7.4 Characteristics

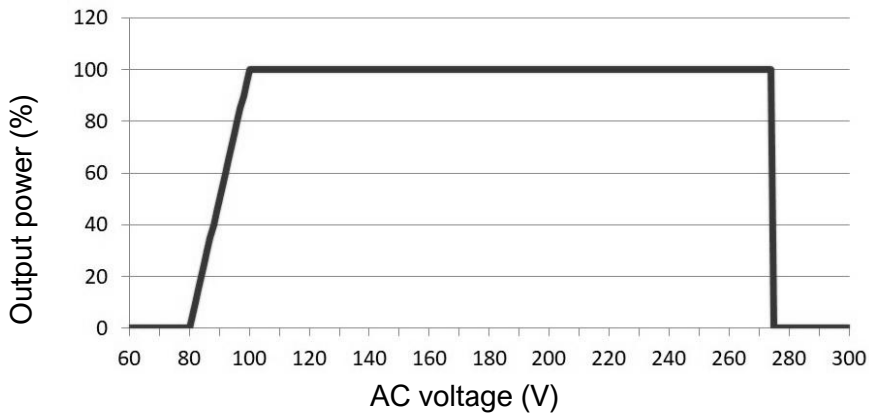

Figure 8: Output power versus input voltage

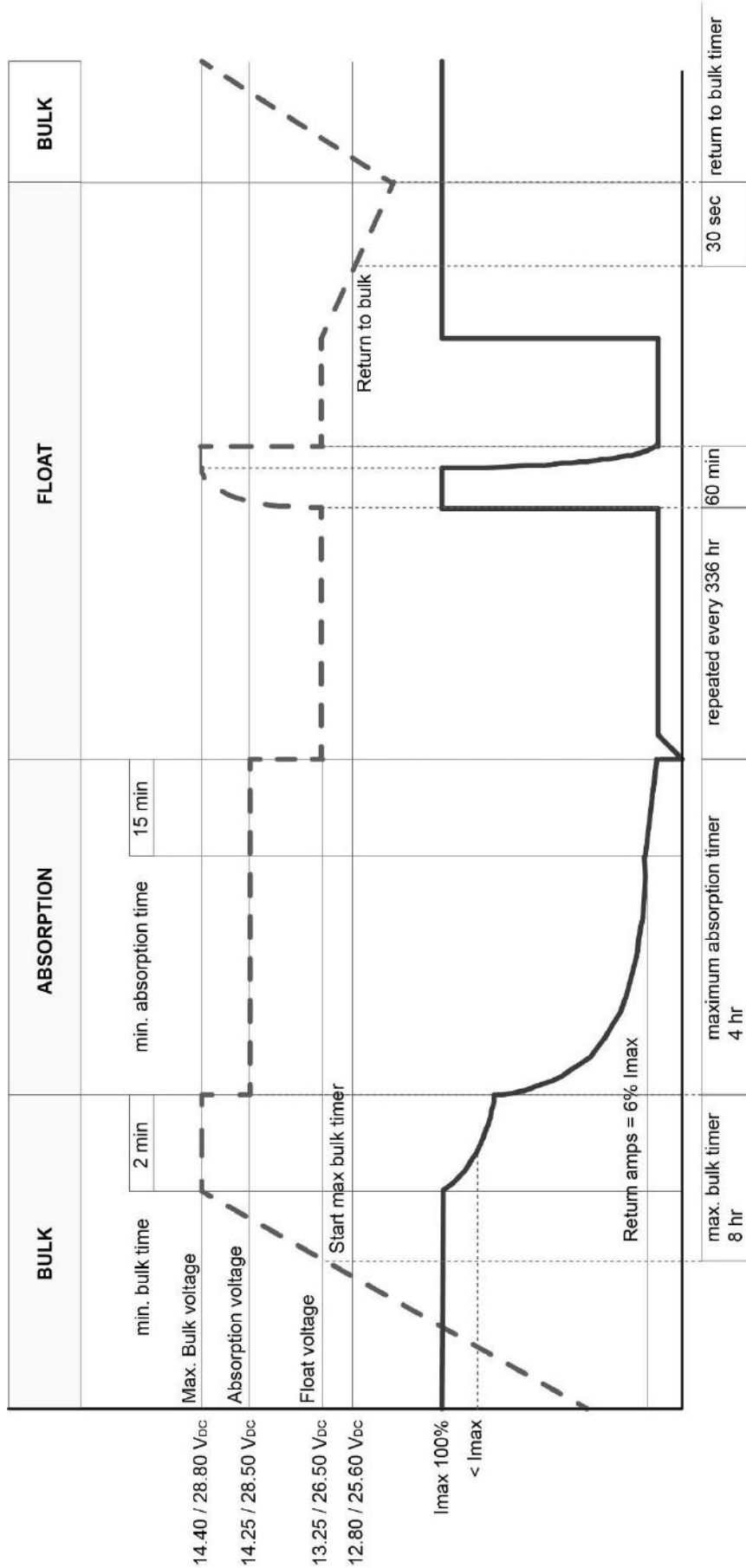

Figure 9: 3-step+ charging characteristics of flooded batteries



Europe, Middle East & Africa

Customer Service

T: +31 (0) 20 34 22 100

E: info@mastervolt.com

Technical Support

T: +31 (0) 20 34 22 100

E: ts@mastervolt.com

Location & Shipping

Mastervolt

Snijdersbergweg 93

1105 AN Amsterdam

The Netherlands

Americas & Caribbean

Customer Service

T: +1 800 307 6702, Option 1

E: orderentry@marinco.com

Technical Support

T: +1 800 307 6702, Option 2

E: tsusa@mastervolt.com

Location & Shipping

Power Products, LLC

N85 W12545 Westbrook Crossing

Menomonee Falls, Wisconsin 53051

United States

Asia Pacific

Customer Service

T: +64 9 415 7261 Option 1

E: enquiries@bepmarine.com

Technical Support

T: +64 9 415 7261 Option 3

E: technical@bepmarine.com

Location & Shipping

BEP Marine

42 Apollo Drive

Rosedale, Auckland 0632

New Zealand