

# M2 OLED Bilge Monitor Instructions

PN 1842

## Installation Checklist

- Check for components included
- Read Warning and Cautions
- Read page 3 for mounting instructions
- Read System Overview, Mounting Considerations, Detailed Wiring, and Sensing Description
- Follow Initial System Setup instructions
- Configure Displays
- Configure Alarms
- Configure Relays

## Specifications

Display Size	55mm x 28mm
Power Supply	7V–70V DC
Power Consumption	0.3W–1.0W*
Alarm/Relay Notification	Run time per hour Cycles per 24-hour Cycle Counter

Cycle Counter

Compatible with bilge monitors with external floats switches or with automatic bilge switches that indicate on status via a 12V output.

\* Variable with voltage, display intensity, and sleep mode

## Regulatory

Monitor face is IP66 – protected against powerful water jets when installed according to instructions

## Warning and Caution Symbols

**WARNING:** The  symbol refers to possible injury to the user or significant damage to the monitor if the user does not follow the procedures.

**CAUTION:** The  symbol refers to restrictions and rules with regard to preventing damage to the monitor.

### WARNING

- If you are not knowledgeable about electrical systems, have an electrical professional install this unit. The diagrams in these instructions pertain to the installation of M2 Digital Meters and not to the overall wiring of the vessel.
- If an inverter is installed on the vessel, its power leads must be disconnected at the battery before the monitor is installed.
- If an AC generator is installed on the vessel, it must be stopped and rendered inoperable before the monitor is installed.
- Verify that no other DC or AC sources are connected to the vessel's wiring before installing the monitor.

### CAUTION

The back of the unit is not waterproof. Do not install where the back of the monitor is exposed to water.

## Components Included

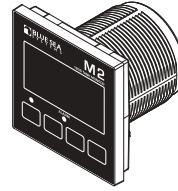

M2 Head Unit

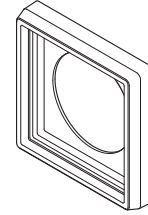

Surface Mount Bezel and Seal

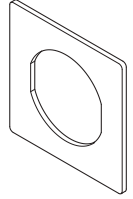

Surface Mount Gasket



Surface Mount Cover

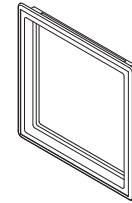

Flat Mount Bezel

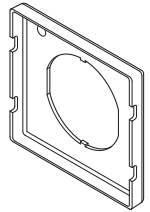

Flat Mount Clamp



Mounting Ring



Mounting Nut

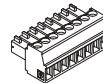

Connector

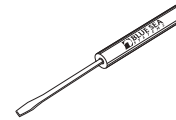

Screwdriver  
Retail Package Only

## 360 Panel Mounting Kit (PN 1525 sold separately)

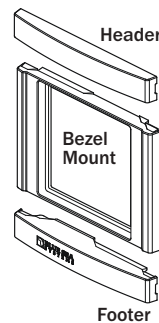

 #6-32 x 1/4"  
Flat Head  
Machine Screws  
(4X)

 #6-32 x 3/8"  
Flat Head  
Machine Screws  
(4X)

## Installation

1. Make all connections to the monitor's terminal block before connecting the terminal block to the unit.  
Keep hands away from the terminal block when applying power to the monitor.
2. As the final DC connection, insert a fuse into the in-line fuse holder on the wire to the positive (+) battery terminal.

## Mounting Templates

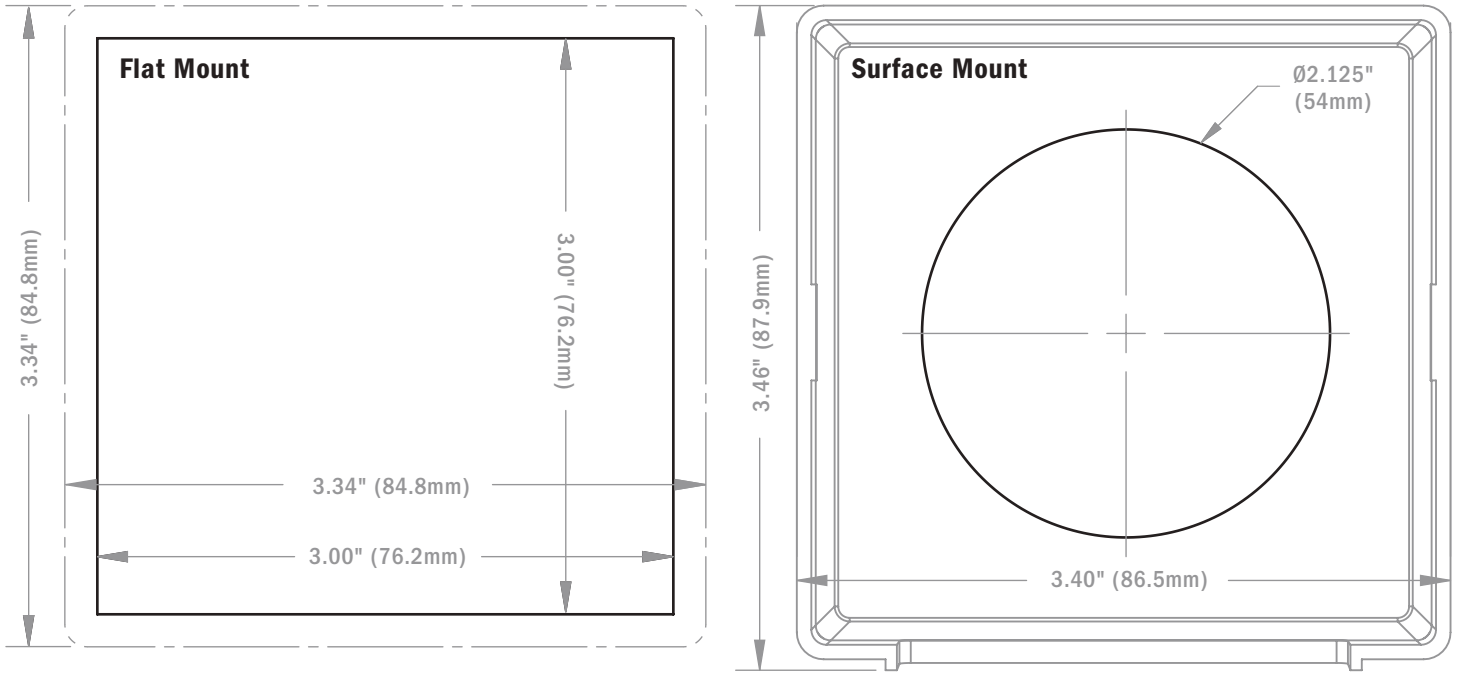

## Mounting Considerations

M2 Digital Monitors have three mounting methods: surface mount, flat panel mount, and 360 panel mount. When surface mounted per instructions the unit face is waterproof to IP66. Flat panel and 360 panel mounting systems are not waterproof. The unit should not be flat panel or 360 panel mounted if used in an exposed location. For all mountings, the back of the unit is not waterproof and must be kept dry.

## Flat Mount

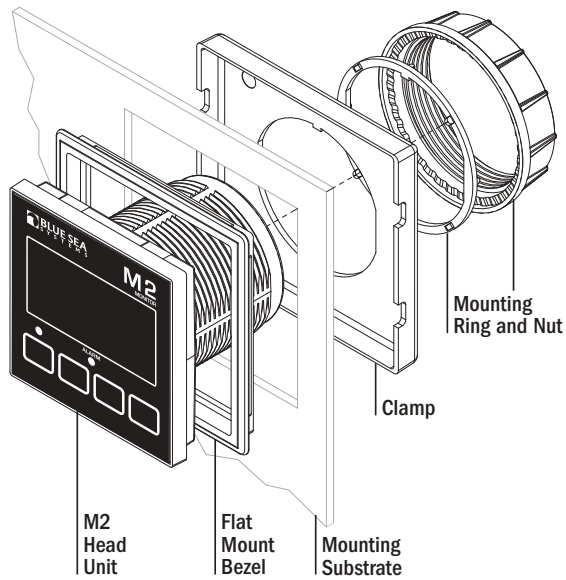

## 360 Panel Mount PN 1525

**STEP 1**  
Use 1/4" Mounting Screws

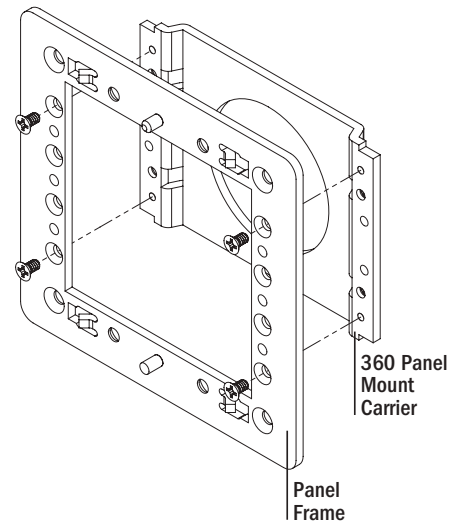

## Surface Mount

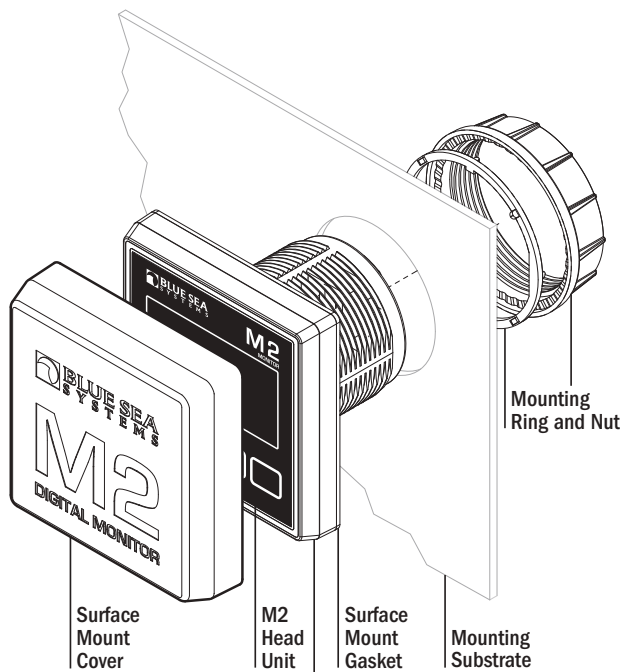

**NOTE:** During installation use cover to align the bezel and gasket

Surface Mount Bezel and Seal

**STEP 2**

Snap header and footer into mounting clips and post. Snap the mounting bezel into place with the flat edge up.

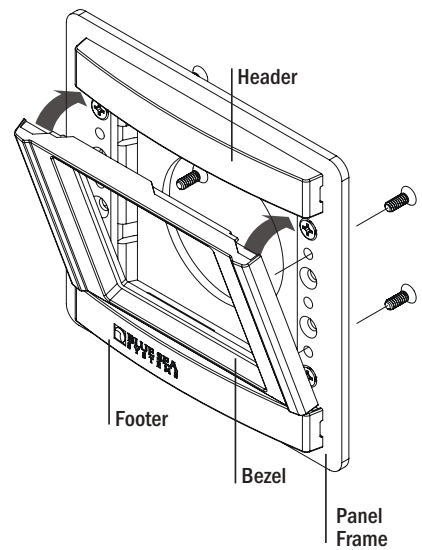

**STEP 3**

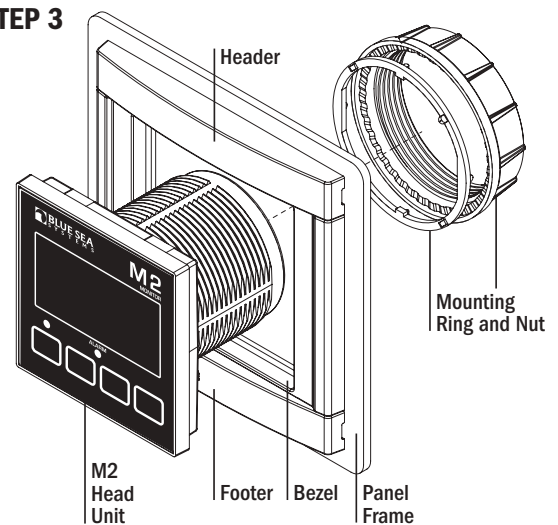

## Bilge Functions (1842)

Monitor up to four bilge pumps. Provides High/Low level alarms for each channel.

## Connections

**IMPORTANT!** The Sensing Description section of this manual gives important details to the location of sensors in the AC and DC electrical systems of the boat. Improper location and configuration of sensors can result in erroneous readings and possible damage to components.

## Pin-out Table

### 1842 Connector Pin Assignment Table

8 Pin Connector*	Function
1 <i>Required Connection</i>	DC Negative
2 <i>Required Connection</i>	DC Supply
3	Relay DC Out to Load
4	Relay DC +
5	Bilge Pump 1
6	Bilge Pump 2
7	Bilge Pump 3
8	Bilge Pump 4
USB	Micro USB Port

\*The 8 pin low voltage connector supports wire sizes from 16-26 AWG

## Monitor Power Supply Connections

All monitors must have pins 1 (DC Negative) and 2 (DC Supply) connected. These pins are used to provide power to the monitor. Connect pin 1 to ground and pin 2 to a 12V to 48V power source.

## Bilge Connections

The 1842 Bilge Monitor will register any bilge activity anytime the bilge input is greater than 5 volts. The inputs can be connected directly to a float switch or the bilge motor supply.

**Note:** The 1842 Bilge Monitor is not compatible with most automatic style bilge pumps.

# Detailed Wiring

## 1842 Bilge Pump Monitor

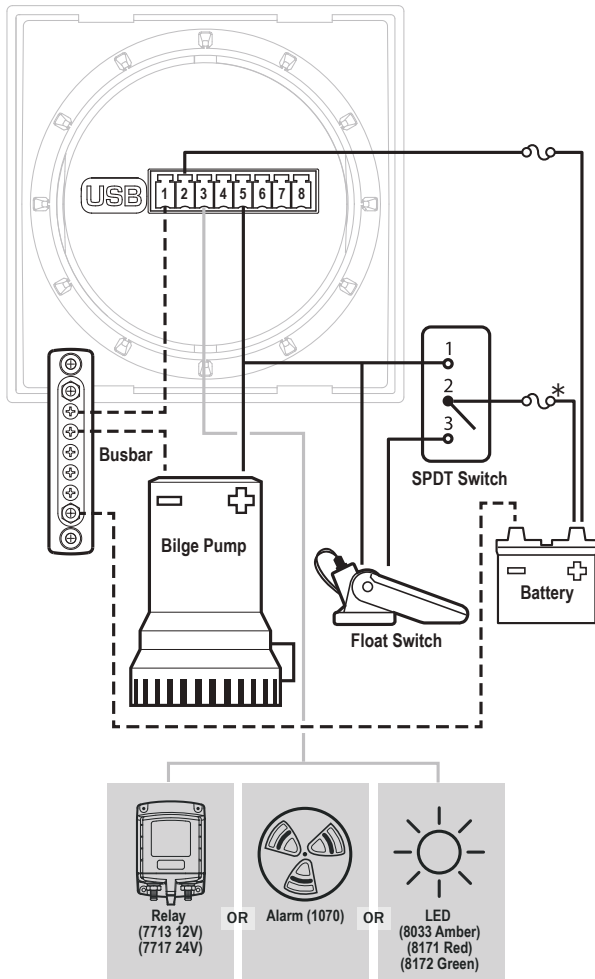

\* Use bilge pump manufacturers recommended fuse.

### Float Switch Connections

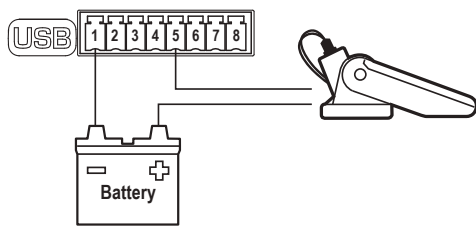

## M2 Relay Connections

M2 Meters contains an internal MOSFET relay that can drive external DC loads up to 0.5A. The input is protected with a thermally activated auto-resetting fuse that will protect against shorts. In addition, an inline fuse rated at 5A should be used to protect against shorts. In typical applications, a power source is connected to the Relay+ pin and a load is connected to the Relay Out to Load connection.

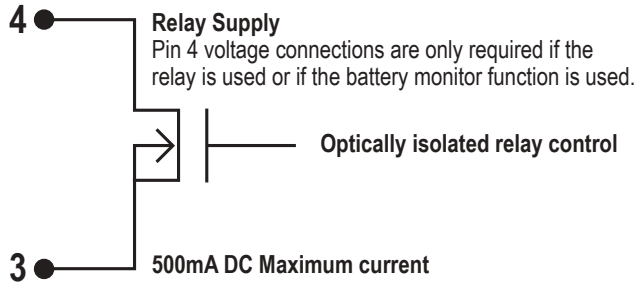

## External LED

An external LED such as 8171 can be connected to the Relay Output terminal. If the system is going to operate at more than 24V nominal, an additional 4K Ohms of resistance should be placed in-line with the LED.

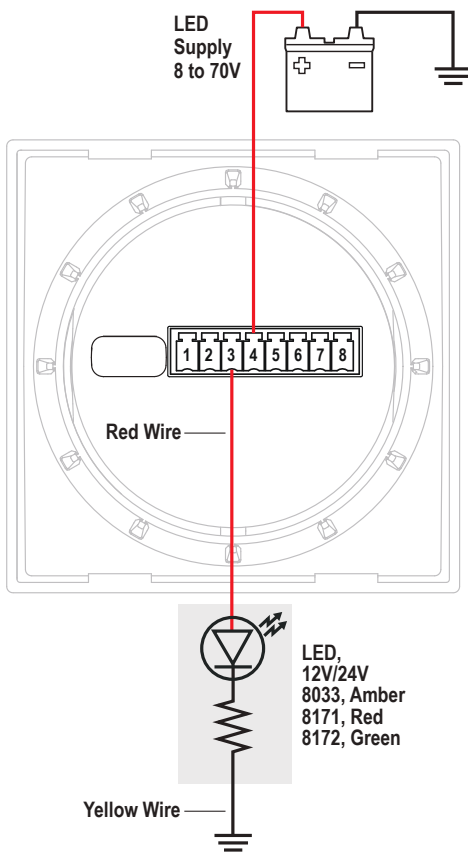

## External Alarm (1070 Floyd Bell Turbo)

The Relay+ terminal can support an external audible alarm. Such as the Floyd Bell Turbo Alarm (1070).

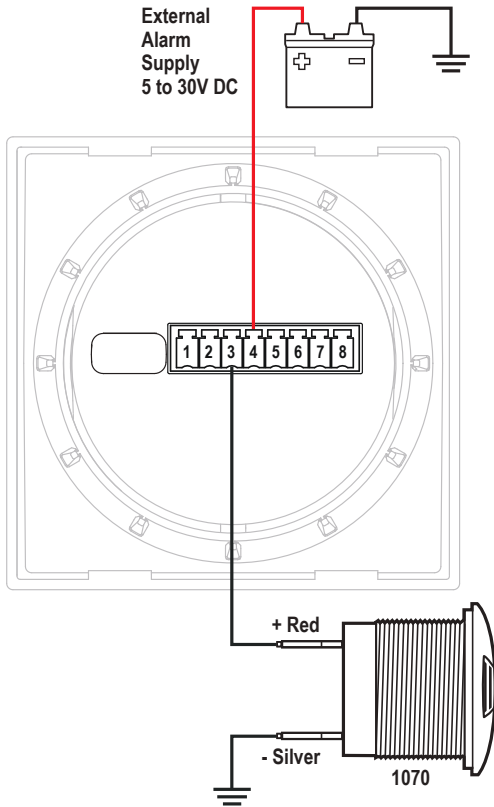

## External Relay

If you need to switch more than 0.5 A, you can use an external relay such as PN 7713, 12V or PN 7717, 24V Remote Battery Switch. Connect the Relay+ terminal to the red control wire. Activating the internal relay will also activate PN 7713.

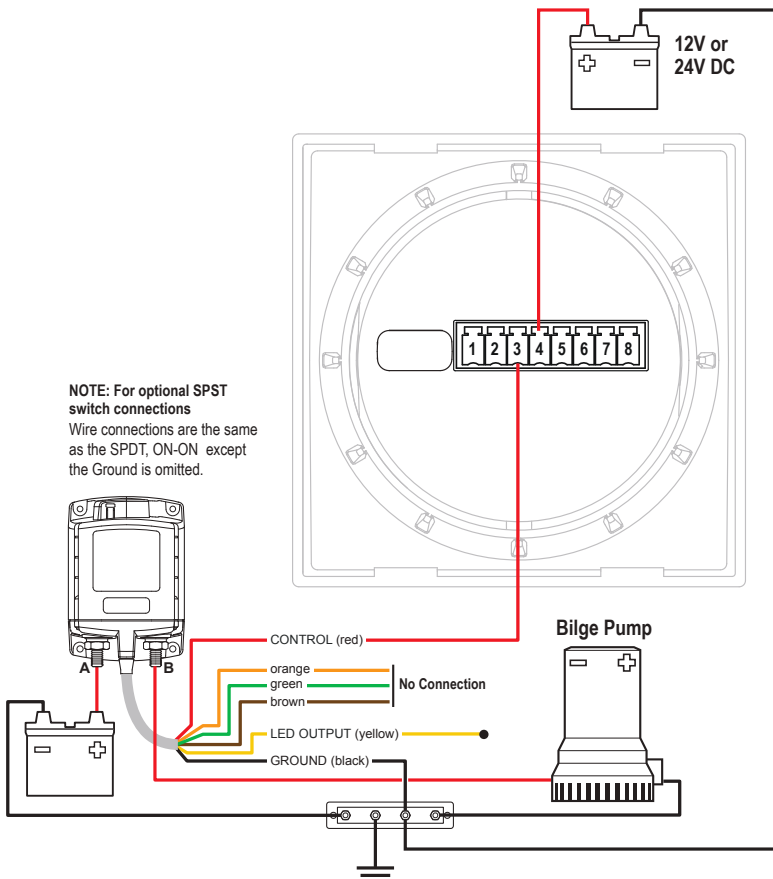

**NOTE:** 9012, 7700, 7701, 7702, & 7703 Remote Battery Switches are not compatible with the internal relay.

# Getting Started

## Example Screens From PN 1842 Bilge Monitor

When an M2 Meter is initially powered up, it will display the Blue Sea Systems Logo, its serial number and its Software revision. After a couple of seconds, the unit will display a high-level System Summary screen.

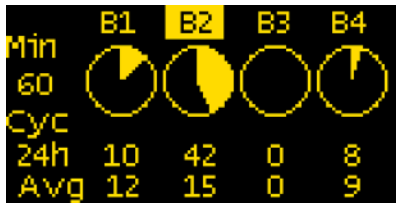

Pressing any button will display a temporary pop-up menu. Select an option by pressing the button beneath it. The pop-up menu will disappear after the first button is pressed.

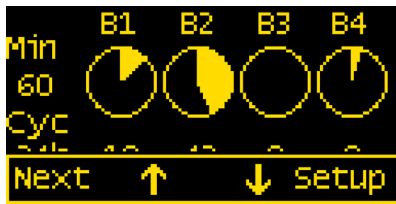

The menu system is a two dimensional matrix. Pressing the **NEXT** button will transition the display between the System Summary screen which displays summary information for each of the “bilge pump” channels.

Press the **UP** ↑ or **DOWN** ↓ arrow buttons to display more detailed information about an input channel or to show a single parameter, such as “B1” in the display (see example below).

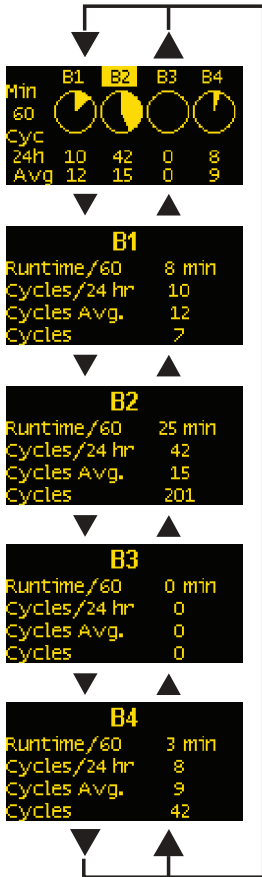

Press the Menu button to bring up the Setup menus. Press the **UP** ↑ and **DOWN** ↓ arrow buttons to move the cursor over the options and press the **Select** button to see a selected display. To return to the previous display, press the **Back** button.



# Configuring the Monitor

Monitor settings can be configured from the Setup menu. This menu can be accessed by pressing the **Menu** button and then scrolling to and selecting Setup. Press the **UP** ↑ and **DOWN** ↓ arrow buttons to move the cursor. The different setup options are described below.



## Alarm Setup & Control

The meter monitors two different conditions that can active an alarm. The meter monitors the amount of time the bilge is active over the last 60 minutes. The monitor can be set to sound an alarm anytime the monitor exceeds a certain on time. The monitor can also monitor the number of cycles that have occurred in the last 24 hours. Alarms can be set from the Alarm Setup menu. To get there, first navigate to the Setup menu. Then scroll to Alarm Setup and press the **Select** button.

### Setting Alarms

The M2 Monitor family provides monitoring capability of bilge input channels. Alarms are triggered if a channel is above or below a certain user selected threshold value. The following example indicates how to setup a run time high alarm.

1. Go to the Alarm Setup menu.
2. Scroll to the desired input channel (i.e., Bilge 1 Hi).
3. Press the Select button and the cursor should start blinking.
4. Set the bilge threshold using the ← and → buttons. (Holding down the buttons allows faster selection)
5. Press the **Enter** button to save the change or the **Cancel** button to cancel any change.

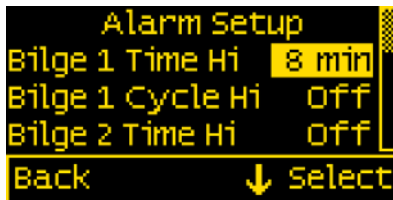

In the above example, an alarm will set anytime Bilge 1 is running longer than or equal to 8 minutes.

### Clearing Alarms

When an alarm occurs, the buzzer will sound, the red ALARM LED will light, and the screen will display which alarm was triggered, the Alarm set point and the current value. Pressing any button silences the buzzer and another button press returns to the previous display.

Until the cause of the alarm is resolved, the ALARM LED will remain on and the channel that triggered the alarm will blink.



## Viewing Alarms Status

For any active alarm, the parameter will flash if it is displayed. To view a complete list of active alarms, press **Menu>Setup>Alarm Setup**. Any active alarm will flash. You may have to scroll through the menu to see all of the alarms.

## Relay Setup & Control

M2 Monitors provide an option to control an external relay. The M2 can trigger the relay based on runtime in an hour or the number of cycles in 24 hours.

These relay options can be set from the Relay Setup menu. To get there, first navigate to the **Setup** menu. Then scroll to **Relay Setup** and press the **Select** button.

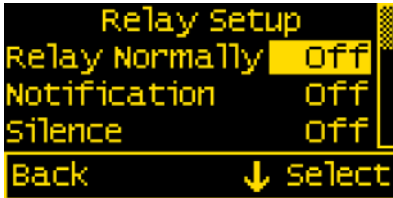

### Relay Normally On/Off

This setting sets the normal operating state of the connected relay. The options are ON or OFF where ON means the relay is on (contacts closed) in normal operation and OFF means it is normally off (open contacts). Scroll to Relay Normally, press **Select** (selection will flash), then press the **LEFT ←** or **RIGHT →** arrow buttons to change the setting. Press **Enter** to save your selection. Press **Cancel** to cancel a change.

### Notification

The Notification setting controls whether or not a notification is displayed when a relay is activated. Notifications will show which relay threshold was surpassed and for which channel. Scroll to Notification and press **Select** to change the setting. Press the **LEFT ←** or **RIGHT →** arrow buttons to choose either ON or OFF. ON will display notifications and OFF will not. Use this option if you don't want to be notified that the relay is activating. Press **Enter** to save the setting or **Cancel** to cancel a change.

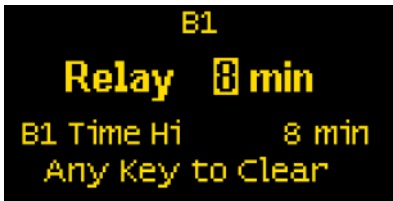

### Silence Relay

Turn this option on if you want the relay to de-activate after the user presses a key on the display. The key press will only de-activate the relay and will not engage any functions on the monitor. For example, this option could be used to silence an external buzzer. Scroll to Silence and press **Select** to change the setting. Press the **LEFT ←** or **RIGHT →** arrow buttons to choose either ON or OFF. Press **Enter** to save the setting or **Cancel** to cancel any change.

## Viewing Relay Status

To view a complete list of active relays, press **Menu>Setup>Relay Setup**. Any active relay will flash.

## Setting Input Thresholds

Settings for each channel's high and low thresholds are provided. The connected relay's normal operating state will toggle (change state) if these thresholds are met. For both high and low thresholds, the activation and deactivation levels are different to prevent the relay from rapidly toggling (cycling on and off). Each channel has Hi ON and Hi OFF settings and Lo ON and Lo OFF settings.



Relay Setup Screen with Relay Normally = On (Closed)



Relay Setup Screen with Relay Normally = Off (Open)

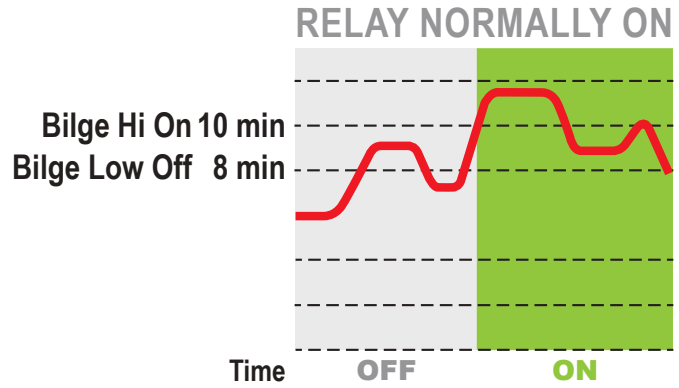
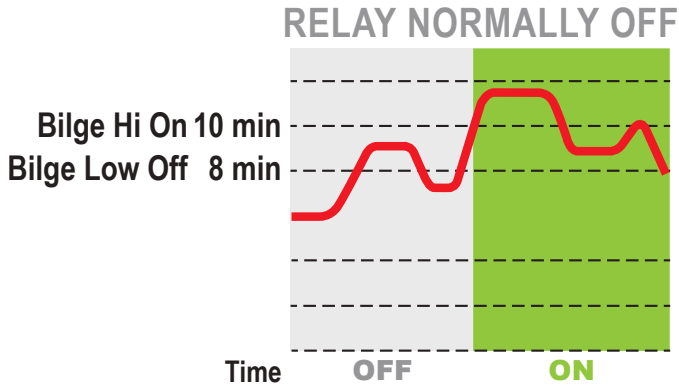

### LEGEND

Bilge Run Time —

**Example.** If the relay is Normally On (closed) and Bilge 1 is configured as above, then it will open when the bilge has been running longer than 10 minutes in any given hour. When the runtime drops below 8 minutes/hr then the relay will turn off again.

To change one of the settings, scroll to desired setting and press **Select**. Press the **LEFT** ← or **RIGHT** → arrow buttons to change the value and then press **Enter** to save the setting. Press **Cancel** to cancel the change.

**NOTE:** Lower threshold settings cannot be set above higher threshold settings. Similarly, higher thresholds cannot be set below lower thresholds. The monitor will automatically increase or decrease the thresholds to enforce this.

## Clearing Relay Notification

If the Notification option is set to ON then any time the relay is opened (Normally Off) or closed (Normally On). A message will be displayed on the main screen. Pressing a key will clear this notification. If Silence is set to ON then the relay will be opened (Normally Off) or closed (Normally On).

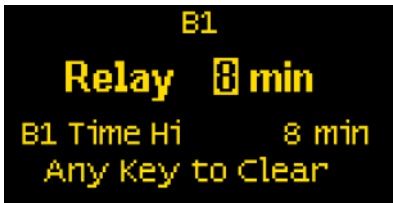

## Viewing Relay Status

For any active alarm, the parameter will flash if it is displayed. To view a complete list of active alarms, press **Menu>Setup>Relay Setup**. Any active relay will flash.

## Display Setup

The monitor display settings can be accessed from the Display Setup menu. From the setup screen, scroll to Display Setup and press the **Select** button. The different display settings are described below. To change a setting, press Enter and press the **LEFT ←** or **RIGHT →** arrow buttons to view the available setting options. Press **Enter** to save the setting. Press **Cancel** to cancel a change.

### Brightness

This setting is for adjusting the brightness of the display. The value is a percentage where 0 % is dimmest and 100 % is brightest.

### Sleep Timer

Following a certain period of inactivity, the monitor will enter a sleep mode and will turn off the display. Any button may be pressed to exit the sleep mode and restore the display. The Sleep Timer sets the number of minutes from 0 to 600 before entering sleep mode. This feature will be disabled by changing the setting to **OFF**.

### Dim Timer

In addition to sleep mode, the monitor can also dim its display after a period of inactivity. The duration of delay in minutes from 0 to 600 can be adjusted with this setting. This feature will be disabled by changing the setting to OFF. By continuously pressing the **LEFT ←** button the monitor can be placed in AUTO dim mode. In this mode the monitor will automatically dim after two minutes when the ambient light is low (night mode). When the light comes back on, the monitor will revert to its normal brightness.

### Demo Mode

With Demo Mode ON, the monitor displays factory programmed values. Changing the setting to OFF returns the monitor to display actual measured values. This mode is typically used for commercial or promotional purposes. Note: Alarms and Relay settings will still respond to the actual settings and not the Demo settings. To enter Demo Mode, press **Menu>Setup>Display Setup>Demo Mode**. Press the **LEFT ←** or **RIGHT →** arrow buttons to toggle Demo Mode ON or OF

# Bilge Setup

## Changing System Labels

The M2 allows the user to change the labels that are displayed above each channel. Each channel can have a maximum of 16 characters however in the summary screens only the first 11 or 12 characters of the channel label are displayed.

## Changing Label Names

To change the name of a bilge channel, follow the instructions below:

1. Navigate to the setup menu for the desired bilge channel. **Menu->Setup->Bilge 1 Setup**
2. In the battery setup menu, move the cursor to bilge channel name to be changed (indicated by the >> symbol)
3. Press **Select** to enter the name editing mode.
4. Use the **LEFT ←** and **RIGHT →** arrow buttons to move the cursor over the characters.
5. When the cursor is over a character, press **Enter** to edit that character. The cursor will start blinking.
6. Use the **UP ↑** and **DOWN ↓** arrow buttons to select a new character and press **Ok** to set that character.
7. Once all desired characters have been changed, press the **Cancel** button to exit the name editing mode.

Note: Although the maximum label length is 14 characters, some screens may only be able to display the first 5 or so characters.

## Additional Bilge Settings

The monitor provides custom settings for each bilge input. To access these settings, first go to the Setup menu.

Scroll to the desired bilge channel.

The bilge setup settings are described below. To make a change, scroll to setting and press **Enter**. Press the **LEFT ←** or **RIGHT →** arrow buttons to view the available setting options. Press **Enter** to save the setting. Press **Cancel** to cancel a change.

### Enable

To display the bilge measurements, change this setting to **ON**. If enable is **OFF**, the bilge along with its measured values will not be displayed. However, any associated alarm or relay settings are still activate. To de-activate the alarm or relay, disable them in the Alarm Setup and Relay Setup menus.

### Cycle Reset

Resets the bilge cycle counter to zero.

## Version Info

The Version Info option in the Setup menu displays the product name, serial number, and software version. This information will be displayed on a screen after scrolling to Version Info and pressing Select. Pressing any button will return to the Setup menu.

## Factory Reset

The Factory Reset option in the Setup menu allows the user to restore the monitor's factory default settings. First scroll to Factory Reset and press Select. Text will appear asking to confirm or cancel the reset request. Press Yes to confirm or No to cancel the reset.

## Software Upgrade

The monitor firmware can be updated in one of two ways. The first option is to use the Software Upgrade option in the Setup menu. The second option is to force the monitor into upgrade mode on startup.

Each method involves using a USB memory stick connected to the USB port on the back of the monitor. The USB port is a type A/B micro USB port. This port is also known as a Micro USB Host OTG. Available at Best Buy or Amazon: <http://amzn.com/B00J631SU8>

**CAUTION**  Removing power or the USB memory stick during the upgrade process will render the monitor inoperable.

Both methods are described below:

### Upgrade via Software Upgrade Option

Download a new version from <http://www.blueseas.com/m2firmware>.

Copy firmware to a USB Memory Stick. The file name should be image.1842.bin., where 1842 is the PN of the monitor. i.e., image.1842.bin, etc.

Remove USB dust cover plug.

Insert memory stick into the USB socket on back of the monitor. Note: You may need an adapter dongle to interface between the memory stick and the monitor (<http://a.co/6eHeaMK>).

Select Software Upgrade option.

Answer Yes to "Are you sure you want to update the Flash?"

The red LED on the M2 will rapidly flash for about 10 seconds.

If the upgrade was successful, a message with the new software version will be displayed.

If there is an error then a message will be displayed (see error messages below).

Remove USB memory stick.

Replace USB dust cover with "USB" text right side up.

Download a new version from <http://www.blueseas.com/m2>.

Copy firmware to a USB Memory Stick. The file name should be image.1842.bin., where 1842 is the model number of the monitor. i.e., image.1842.bin, etc. Turn off the power to the unit.

Remove USB dust cover plug.

Insert the memory stick into the USB socket on back of the unit. Note: You may need an adapter dongle to interface between the memory stick and the monitor: (<http://a.co/6eHeaMK>).

While pressing and holding the leftmost and rightmost keys, turn the power to the monitor ON.

The red LED on the M2 will rapidly flash for about 10 seconds.

If the upgrade was successful, a message with the new software version will be displayed.

If there is an error then a message will be displayed (see error message below).

Remove USB memory stick.

Replace USB dust cover with USB label facing up.

Upgrade via Forcing Monitor into Upgrade Mode

### Upgrade Messages

Flash Successful / SW Version: xxx - Upgrade successful.

File Not Found - A valid flash image was not found on the monitor. The downloaded upgrade filename should be image.1842.bin, where xxxx is the model number of the monitor. i.e., image.1841.bin, image.1842.bin, etc.

Corrupted File - The image is not valid or corrupted. Re-download the updated image from [www.blueseas.com](http://www.blueseas.com).

No USB Device - The USB memory card is not plugged in or the cable is defective.

Wrong Model Number - The image file is for a different monitor. Download a new file from [www.blueseas.com/m2firmware](http://www.blueseas.com/m2firmware).

Wrong HW Version - The new image file does not support this revision of hardware.



425 Sequoia Drive  
Bellingham, WA 98226 USA

p 360.738.8230  
p 800.222.7617 USA and Canada Customer Service  
f 360.734.4195  
conductor@blueseas.com  
www.blueseas.com