

M2 OLED Temperature Monitor Instructions

PN 1841

Installation Checklist

- Check for components included
- Read Warning and Cautions
- Read page 3 for mounting instructions
- Read System Overview, Mounting Considerations, Detailed Wiring, and Sensing Description
- Follow Initial System Setup instructions
- Configure Displays
- Configure Alarms
- Configure Relays

Specifications

Display Size	55mm x 28mm
Power Supply	7V–70V DC
Power Consumption	0.3W–1.0W*
Sensors	Blue Sea Systems PN (1821)
Sensor Range	-40°F – 250°F (-40°C – 120°C)
Sensor Resolution	1%
Temp Alarms	80dB
External Relay	0.5A DC

* Variable with voltage, display intensity, and sleep mode

Regulatory

Monitor face is IP66 – protected against powerful water jets when installed according to instructions

Warning and Caution Symbols

WARNING: The  symbol refers to possible injury to the user or significant damage to the meter if the user does not follow the procedures.

CAUTION: The  symbol refers to restrictions and rules with regard to preventing damage to the meter.

WARNING

- If you are not knowledgeable about electrical systems, have an electrical professional install this unit. The diagrams in these instructions pertain to the installation of M2 Digital Meters and not to the overall wiring of the vessel.
- If an inverter is installed on the vessel, its power leads must be disconnected at the battery before the meter is installed.
- If an AC generator is installed on the vessel, it must be stopped and rendered inoperable before the meter is installed.
- Verify that no other DC or AC sources are connected to the vessel's wiring before installing the meter.

CAUTION

- The back of the unit is not waterproof. Do not install where the back of the meter is exposed to water.

Components Included

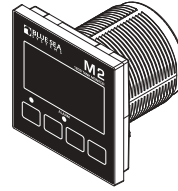

M2 Head Unit

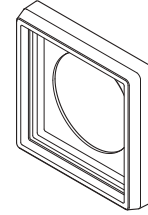

Surface Mount Bezel and Seal

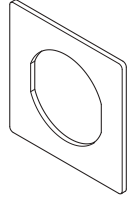

Surface Mount Gasket



Surface Mount Cover

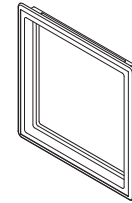

Flat Mount Bezel

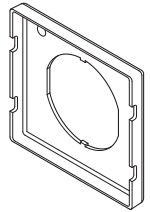

Flat Mount Clamp



Mounting Ring



Mounting Nut

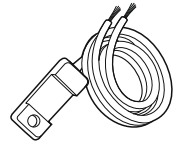

4x 1821
Temperature Sensors

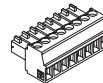

Connector



Screwdriver
Retail Package Only

360 Panel Mounting Kit (PN 1525 sold separately)

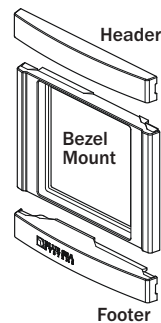

Header



Bezel Mount

Footer

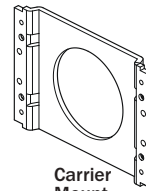

Carrier Mount

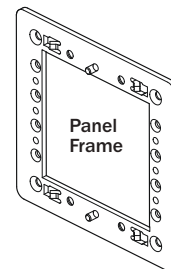

Panel Frame

 #6-32 x 1/4"
Flat Head
Machine Screws
(4X)

 #6-32 x 3/8"
Flat Head
Machine Screws
(4X)

Installation

1. Make all connections to the meter's terminal block before connecting the terminal block to the unit.
Keep hands away from the terminal block when applying power to the meter.
2. As the final DC connection, insert a fuse into the in-line fuse holder on the wire to the positive (+) battery terminal.

Mounting Templates

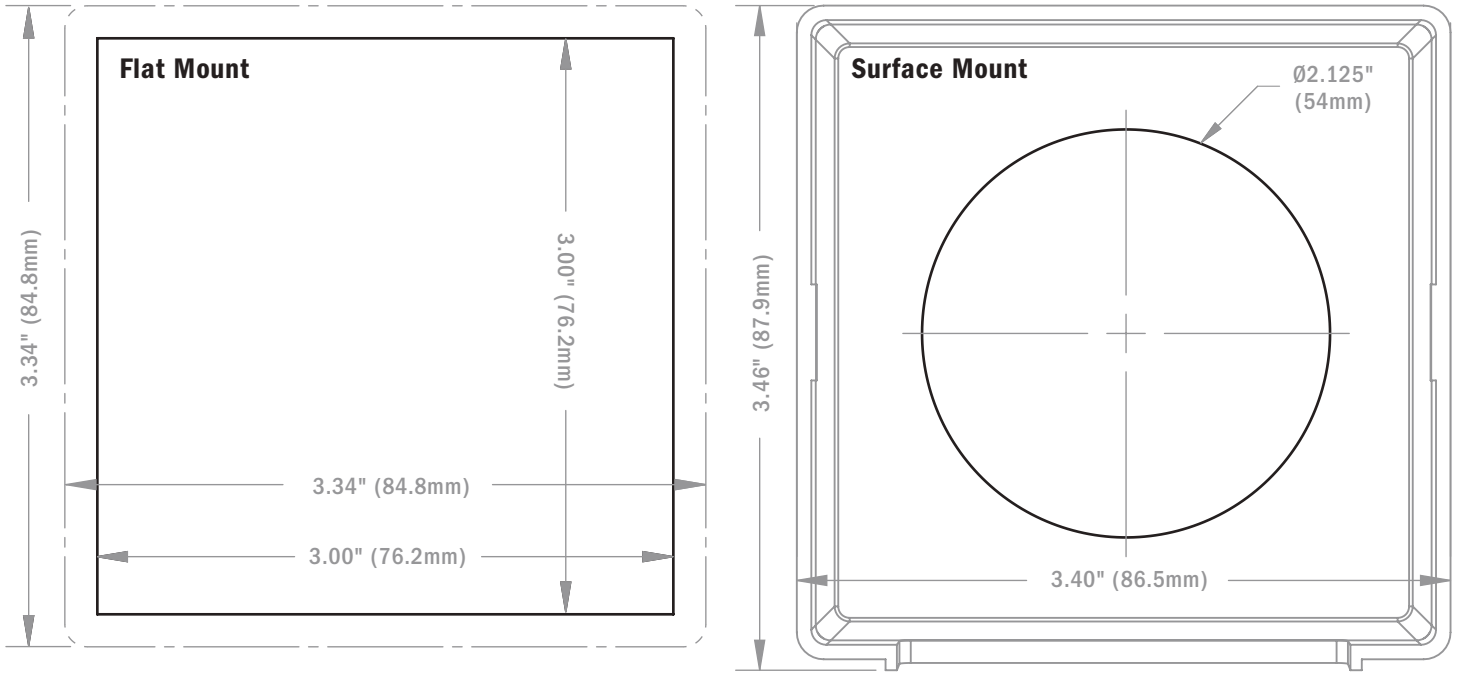

Mounting Considerations

M2 Digital Meters have three mounting methods: surface mount, flat panel mount, and 360 panel mount. When surface mounted per instructions the unit face is waterproof to IP66. Flat panel and 360 panel mounting systems are not waterproof. The unit should not be flat panel or 360 panel mounted if used in an exposed location. For all mountings, the back of the unit is not waterproof and must be kept dry.

Flat Mount

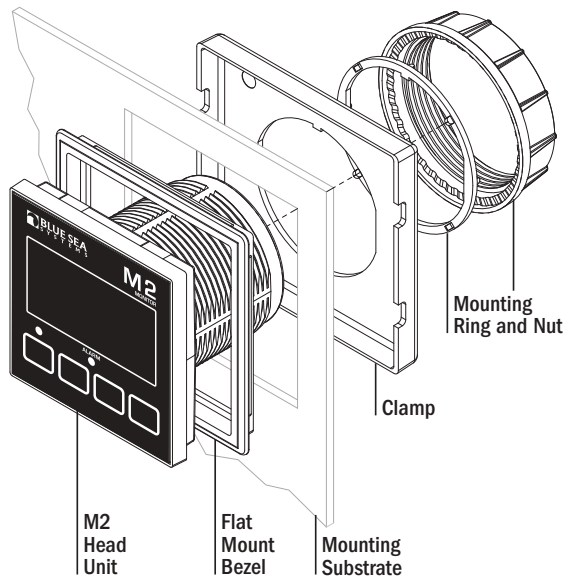

360 Panel Mount PN 1525

STEP 1
Use 1/4" Mounting Screws

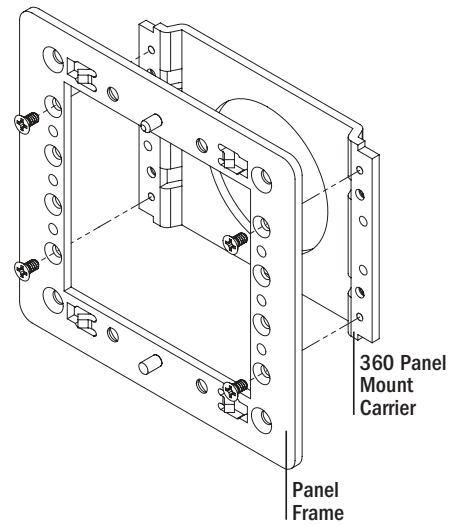

Surface Mount

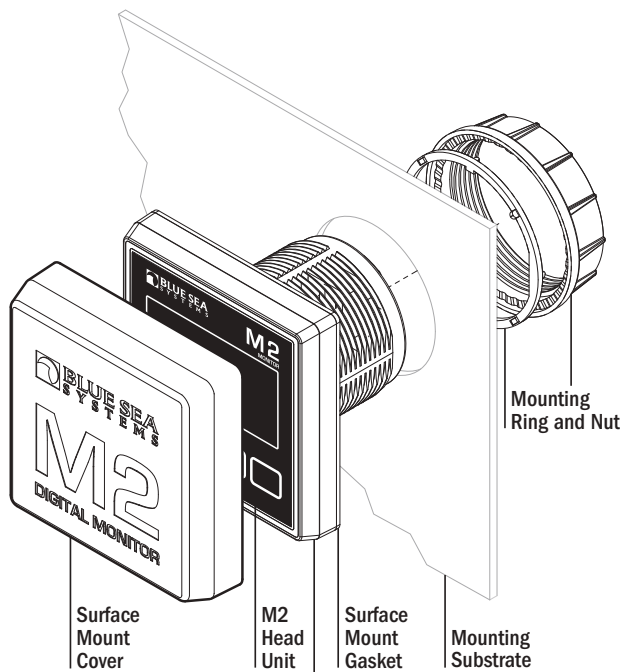

NOTE: During installation use cover to align the bezel and gasket

Surface Mount Bezel and Seal

STEP 2

Snap header and footer into mounting clips and post. Snap the mounting bezel into place with the flat edge up.

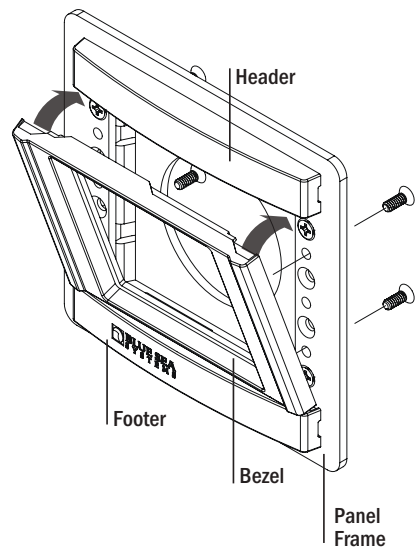

STEP 3

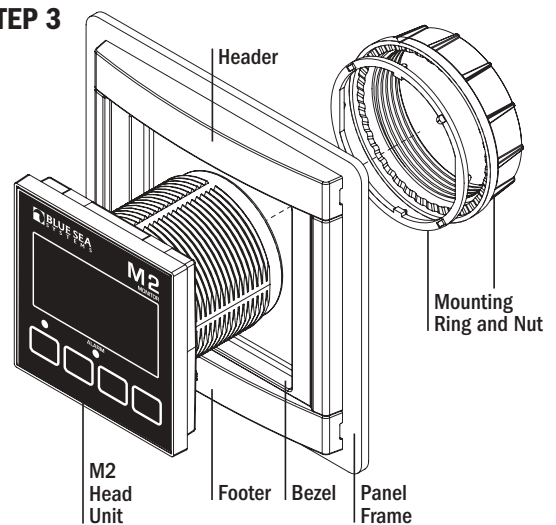

Temperature Functions (1841)

Monitor up to four temperatures. Provides High/Low level alarms for each channel.

Connections

IMPORTANT! The Sensing Description section of this manual gives important details to the location of sensors in the AC and DC electrical systems of the boat. Improper location and configuration of sensors can result in erroneous readings and possible damage to components.

Pin-out Table

1841 Connector Pin Assignment Table

8 Pin Connector*	Function
1 <i>Required Connection</i>	DC Negative
2 <i>Required Connection</i>	DC Supply
3	Relay DC Out to Load
4	Relay DC +
5	Temperature 1
6	Temperature 2
7	Temperature 3
8	Temperature 4
USB	Micro USB Port

*The 8 pin low voltage connector supports wire sizes from 16-26 AWG

Meter Power Supply Connections

All meters must have pins 1 (DC Negative) and 2 (DC Supply) connected. These pins are used to provide power to the meter. Connect pin 1 to ground and pin 2 to a 12V to 48V power source.

Temperature Connections

Use Blue Sea Systems Temperature Sensor 1821

Only use Blue Sea Systems temperature sensor PN 1821. Other temperature sensors may not give the correct temperature result.

The negative lead of all the temperature sensors should terminate as close as possible to pin 1. For a simple and clean installation, use Blue Sea Systems PN 2304 as a small common bus bar for all of the meters DC negative connection. There should be one connection between pin 1 of the meter and the bus bar using 18 AWG wire. This connection should be as short as possible to minimize temperature reading errors.

Detailed Wiring

1841 Temperature Monitor

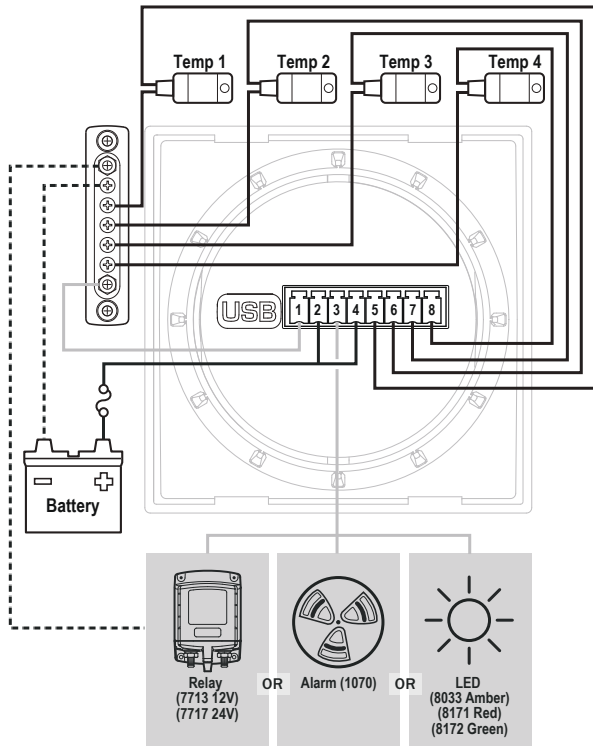

Note: The negative feed of all of the temperature sensors should terminate as close as possible to pin 1. Use Blue Sea Systems' PN 2304 Mini Bus with a short 18 AWG gauge wire from pin 1 to the Mini Bus.

Temperature Sensor Connections 1821

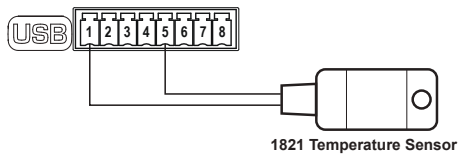

Temperature 1 Example

M2 Relay Connections

M2 Meters contains an internal MOSFET relay that can drive external DC loads up to 0.5A. The input is protected with a thermally activated auto-resetting fuse that will protect against shorts. In addition, an inline fuse rated at 5A should be used to protect against shorts. In typical applications, a power source is connected to the Relay+ pin and a load is connected to the Relay Out to Load connection.

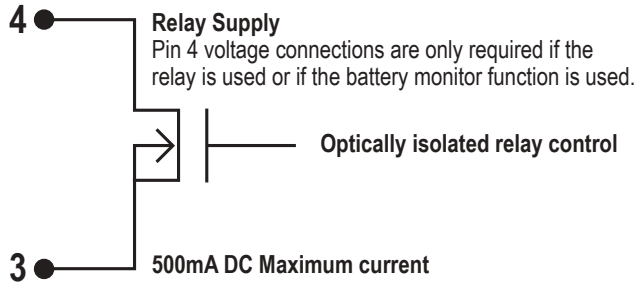

External LED

An external LED such as 8171 can be connected to the Relay Output terminal. If the system is going to operate at more than 24V nominal, an additional 4K Ohms of resistance should be placed in-line with the LED.

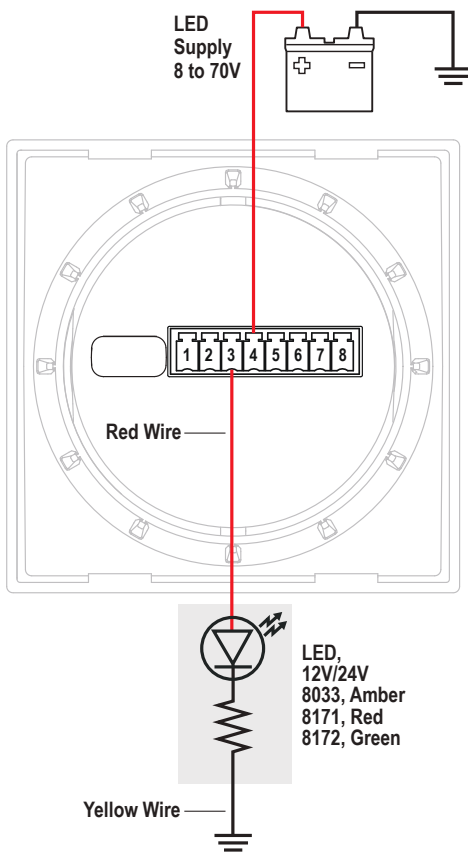

External Alarm (1070 Floyd Bell Turbo)

The Relay+ terminal can support an external audible alarm. Such as the Floyd Bell Turbo Alarm (1070).

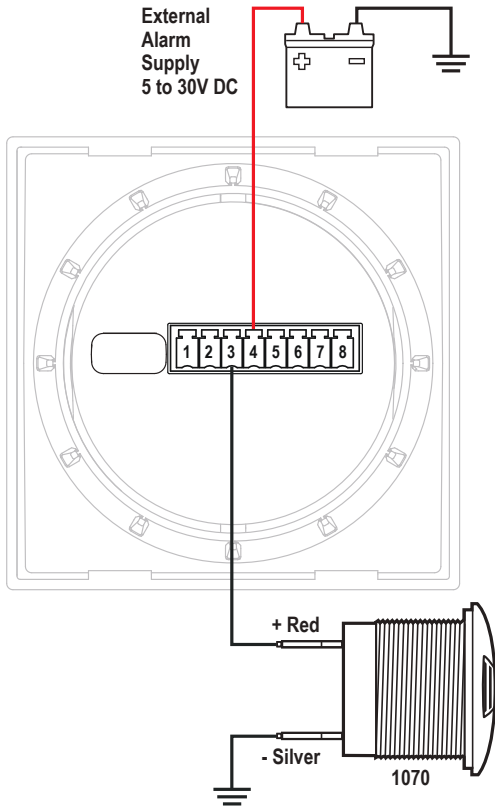

External Relay

If you need to switch more than 0.5 A, you can use an external relay such as PN 7713, 12V or PN 7717, 24V Remote Battery Switch. Connect the Relay+ terminal to the red control wire. Activating the internal relay will also activate PN 7713.

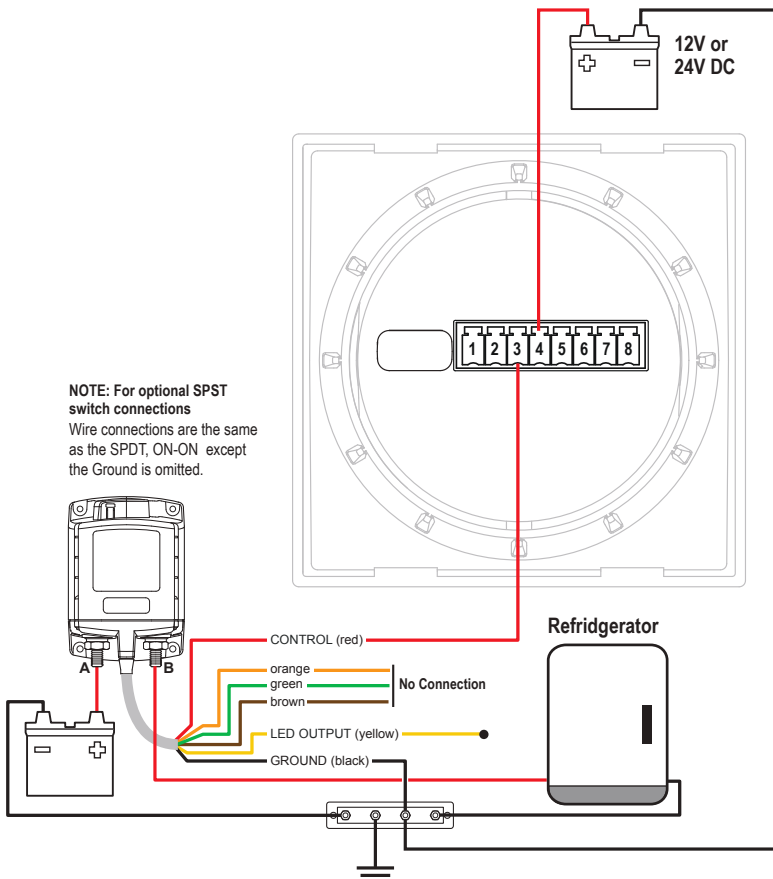

NOTE: 9012, 7700, 7701, 7702, & 7703 Remote Battery Switches are not compatible with the internal relay.

Getting Started

Example Screens From PN 1841 Temperature Meter

When an M2 Meter is initially powered up, it will display the Blue Sea Systems Logo, its serial number and its Software revision. After a couple of seconds, the unit will display a high-level System Summary screen.

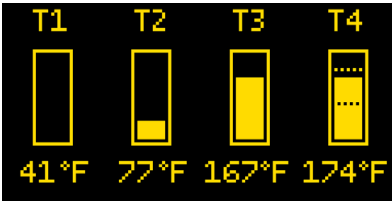

Pressing any button will display a temporary pop-up menu. Select an option by pressing the button beneath it. The pop-up menu will disappear after the first button is pressed.

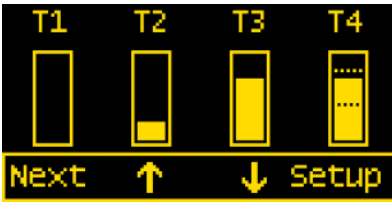

The menu system is a two dimensional matrix. Pressing the **NEXT** button will transition the display between the System Summary screen which displays summary information for each of the "temperature" channels.

Press the **UP** ↑ or **DOWN** ↓ arrow buttons to display more detailed information about an input channel or to show a single parameter, such as "T1" in the display (see example below).

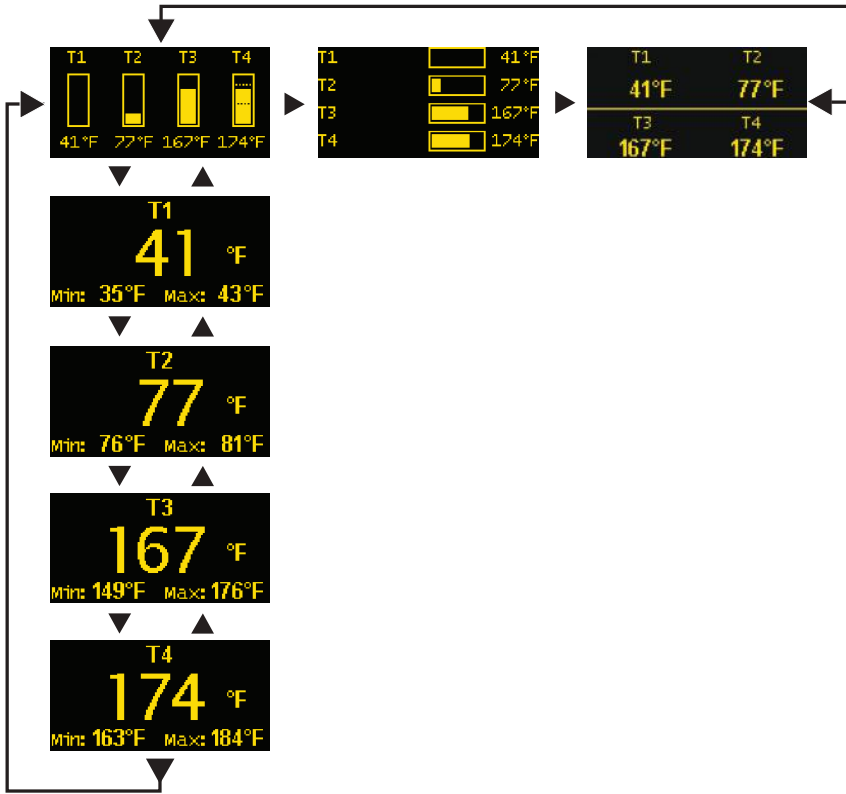

Press the Menu button to bring up the Setup menus. Press the **UP** ↑ and **DOWN** ↓ arrow buttons to move the cursor over the options and press the **Select** button to see a selected display. To return to the previous display, press the **Back** button.

Other Display Indications

The dotted lines in T4 indicate the Hi and Lo Alarm Levels. The Hi and Lo Relay levels are not shown.

If **Display MinMax** is on, then split triangles on the right side of the each graph indicate the minimum and maximum levels. A single triangle indicates that the minimum and maximum levels are close to each other.

The following temperature error messages may be displayed under certain error conditions.

HI -- The temperature is greater than 275°F (135°C).

LO -- The temperature is less than -40°F (-40°C).

NC -- The temperature sensor is not connected.

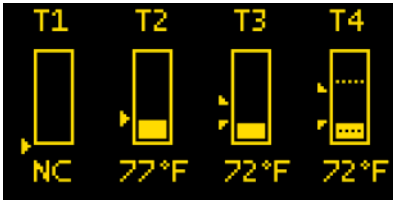

Configuring the Meter

Meter settings can be configured from the Setup menu. This menu can be accessed by pressing the **Menu** button and then scrolling to and selecting Setup. Press the **UP** ↑ and **DOWN** ↓ arrow buttons to move the cursor. The different setup options are described below.



Alarm Setup & Control

The meter's alarm can be set to trigger when a temperature exceeds a threshold. Alarms can be set from the Alarm Setup menu. To get there, first navigate to the Setup menu. Then scroll to Alarm Setup and press the **Select** button.

Setting Alarms

The M2 Meter family provides monitoring capability of temperature input channels. Alarms are triggered if a channel is above or below a certain user selected threshold value. The following example indicates how to setup an over temperature alarm.

1. Go to the Alarm Setup menu.
2. Scroll to the desired input channel (i.e., Temp. 1 Hi).
3. Press the Select button and the cursor should start blinking.
4. Set the temperature threshold using the ← and → buttons. (Holding down the buttons allows faster selection)
5. Press the **Enter** button to save the change or the **Cancel** button to cancel any change.

NOTE: A low temperature level threshold cannot be set above a high temperature threshold. Likewise, a high temperature threshold cannot be set below the low temperature threshold. The meter will automatically increase or decrease the temperature settings to enforce this.

NOTE: The display can be changed from °F to °C in the Display Setup screen.

NOTE: The alarm levels are graphically displayed on the main menu screen.

Temp n Delay

Set the Alarm hold off time in minutes. The hold off timer operates as a count-up/count-down timer. When the temperature exceeds the alarm value then the timer will start counting up until it reaches the delay time. When it reaches the delay timer, an alarm will sound. If the alarm condition goes away before the delay timer has been met, then the timer will count down until the timer is zero again. For example, if the Alarm Delay is set for 5 minutes and an alarm condition is active for 4 minutes and then inactive for 1 minutes then if the alarm condition is active again, the alarm will sound in 2 minutes (5 minutes - 4 minutes + 1 minute). Note that there is only one delay per channel.

Clearing Alarms

When an alarm occurs, the buzzer will sound, the red ALARM LED will light, and the screen will display which alarm was triggered, the Alarm set point and the current value. Pressing any button silences the buzzer and another button press returns to the previous display.

Until the cause of the alarm is resolved, the ALARM LED will remain on and the channel that triggered the alarm will blink.

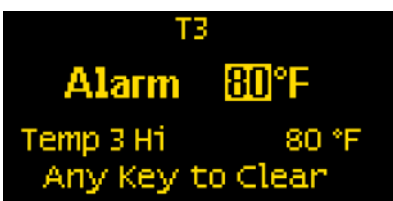

Viewing Alarms Status

For any active alarm, the parameter will flash if it is displayed. To view a complete list of active alarms, press **Menu>Setup>Alarm Setup**. Any active alarm will flash. You may have to scroll through the menu to see all of the alarms.

Relay Setup & Control

M2 Meters provide an option to control an external relay. The M2 can trigger the relay based on high or low temperature levels.

These relay options can be set from the Relay Setup menu. To get there, first navigate to the **Setup** menu. Then scroll to **Relay Setup** and press the **Select** button.

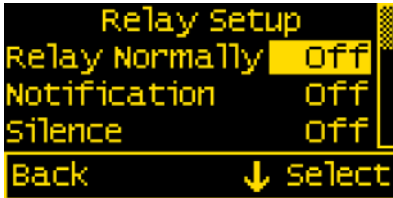

Relay Normally On/Off

This setting sets the normal operating state of the connected relay. The options are ON or OFF where ON means the relay is on (contacts closed) in normal operation and OFF means it is normally off (open contacts). Scroll to Relay Normally, press **Select** (selection will flash), then press the **LEFT ←** or **RIGHT →** arrow buttons to change the setting. Press **Enter** to save your selection. Press **Cancel** to cancel a change.

Notification

The Notification setting controls whether or not a notification is displayed when a relay is activated. Notifications will show which relay threshold was surpassed and for which channel. Scroll to Notification and press **Select** to change the setting. Press the **LEFT ←** or **RIGHT →** arrow buttons to choose either ON or OFF. ON will display notifications and OFF will not. Use this option if you don't want to be notified that the relay is activating. Press **Enter** to save the setting or **Cancel** to cancel a change.

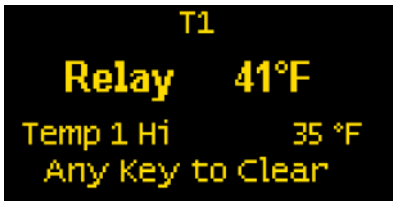

Silence Relay

Turn this option on if you want the relay to de-activate after the user presses a key on the display. The key press will only de-activate the relay and will not engage any functions on the meter. For example, this option could be used to silence an external buzzer. Scroll to Silence and press **Select** to change the setting. Press the **LEFT ←** or **RIGHT →** arrow buttons to choose either ON or OFF. Press **Enter** to save the setting or **Cancel** to cancel any change.

Temp n Delay (Relay)

Set the Alarm hold off time in minutes. The hold off timer operates as a count-up/count-down timer. When the temperature exceeds the alarm value then the timer will start counting up until it reaches the delay time. When it reaches the delay timer, an alarm will sound. If the alarm condition goes away before the delay timer has been met, then the timer will count down until the timer is zero again. For example, if the Alarm Delay is set for 5 minutes and an alarm condition is active for 4 minutes and then inactive for 1 minutes then if the alarm condition is active again, the alarm will sound in 2 minutes (5 minutes - 4 minutes + 1 minute). Note that there is only one delay per channel.

Viewing Relay Status

To view a complete list of active relays, press **Menu>Setup>Relay Setup**. Any active relay will flash.

Setting Input Thresholds

Settings for each channel's high and low temperature thresholds are provided. The connected relay's normal operating state will toggle (change state) if these thresholds are met. For both high and low thresholds, the activation and deactivation levels are different to prevent the relay from rapidly toggling (cycling on and off). Each channel has Hi ON and Hi OFF settings and Lo ON and Lo OFF settings.

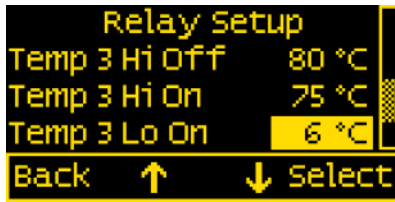

Relay Setup Screen with Relay Normally = On (Closed)



Relay Setup Screen with Relay Normally = Off (Open)

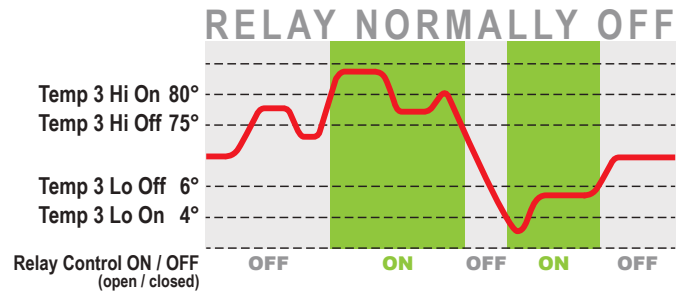
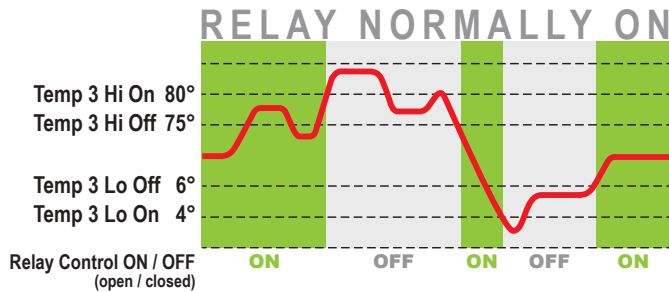

LEGEND

Temp Level —

Example. This setting can be used to notify if there is an over heated wet exhaust line or if the exhaust line is approaching freezing. If the relay is Normally On (closed) and Temperature 3 is configured as above, then it will open when the temperature on channel 3 is greater than Temp 3 Hi On (80°C). To close, the level must drop below Temp3 Hi Off (75°C). Similarly, the relay will open when the temperature is below Temp3 Lo On (4°C, not shown) and then close again when the temperature is above Temp3 Lo Off (6°C).

To change one of the settings, scroll to desired setting and press **Select**. Press the **LEFT** ← or **RIGHT** → arrow buttons to change the temperature value and then press **Enter** to save the setting. Press **Cancel** to cancel the change.

NOTE: Lower threshold settings cannot be set above higher temperature threshold settings. Similarly, higher temperature thresholds cannot be set below lower temperature thresholds. The meter will automatically increase or decrease the temperature thresholds to enforce this.

Clearing Relay Notification

If the Notification option is set to ON then any time the relay is opened (Normally Off) or closed (Normally On). A message will be displayed on the main screen. Pressing a key will clear this notification. If Silence is set to ON then the relay will be opened (Normally Off) or closed (Normally On).



Viewing Relay Status

For any active alarm, the parameter will flash if it is displayed. To view a complete list of active alarms, press **Menu>Setup>Relay Setup**. Any active relay will flash.

Display Setup

The meter display settings can be accessed from the Display Setup menu. From the setup screen, scroll to Display Setup and press the **Select** button. The different display settings are described below. To change a setting, press Enter and press the **LEFT ←** or **RIGHT →** arrow buttons to view the available setting options. Press **Enter** to save the setting. Press **Cancel** to cancel a change.

Brightness

This setting is for adjusting the brightness of the display. The value is a percentage where 0 % is dimmest and 100 % is brightest.

Sleep Timer

Following a certain period of inactivity, the meter will enter a sleep mode and will turn off the display. Any button may be pressed to exit the sleep mode and restore the display. The Sleep Timer sets the number of minutes from 0 to 600 before entering sleep mode. This feature will be disabled by changing the setting to **OFF**.

Dim Timer

In addition to sleep mode, the meter can also dim its display after a period of inactivity. The duration of delay in minutes from 0 to 600 can be adjusted with this setting. This feature will be disabled by changing the setting to OFF. By continuously pressing the **LEFT ←** button the meter can be placed in AUTO dim mode. In this mode the meter will automatically dim after two minutes when the ambient light is low (night mode). When the light comes back on, the meter will revert to its normal brightness.

Units

The temperature meter can display temperatures in °F or °C. Press the **LEFT ←** or **RIGHT →** arrow buttons to toggle to toggle between the °F or °C.

Display Min/Max

Minimum and maximum temperature indicators can be displayed on the main screen by turning this setting to on. The minimum and maximum values can be individually reset in the individual temperature setting menus. The default setting is off.

Demo Mode

With Demo Mode ON, the meter displays factory programmed values. Changing the setting to OFF returns the meter to display actual measured values. This mode is typically used for commercial or promotional purposes. Note: Alarms and Relay settings will still respond to the actual settings and not the Demo settings. To enter Demo Mode, press **Menu>Setup>Display Setup>Demo Mode**. Press the **LEFT ←** or **RIGHT →** arrow buttons to toggle Demo Mode ON or OF

Temperature Channel Setup

Changing System Labels

The M2 allows the user to change the labels that are displayed above each channel. Each channel can have a maximum of 16 characters however in the summary screens only the first 11 or 12 characters of the channel label are displayed.

Changing Label Names

To change the name of a temperature channel, follow the instructions below:

1. Navigate to the setup menu for the desired temperature channel. **Menu->Setup->Temp. 1 Setup**
 2. In the battery setup menu, move the cursor to temperature channel name to be changed (indicated by the >> symbol)
 3. Press **Select** to enter the name editing mode.
 4. Use the **LEFT ←** and **RIGHT →** arrow buttons to move the cursor over the characters.
 5. When the cursor is over a character, press **Enter** to edit that character. The cursor will start blinking.
 6. Use the **UP ↑** and **DOWN ↓** arrow buttons to select a new character and press **Ok** to set that character.
 7. Once all desired characters have been changed, press the **Cancel** button to exit the name editing mode.
- Note: Although the maximum label length is 14 characters, some screens may only be able to display the first 5 or so characters.

Additional Temperature Settings

The meter provides custom settings for each temperature input. To access these settings, first go to the Setup menu.

Scroll to the desired temperature channel.

The temperature setup settings are described below. To make a change, scroll to setting and press **Enter**. Press the **LEFT ←** or **RIGHT →** arrow buttons to view the available setting options. Press **Enter** to save the setting. Press **Cancel** to cancel a change.

Enable

To display the temperature and its measurements, change this setting to **ON**. If enable is **OFF**, the temperature along with its measured values will not be displayed.

However, any associated alarm or relay settings are still activate. To de-activate the alarm or relay, disable them in the Alarm Setup and Relay Setup menus.

Min/Max Reset

Resets the minimum and maximum values for the temperature channel.

Graph Hi/Graph Lo

On the graphical summary screens, set the highest and lowest value on the graph. For example, if we were monitoring our ice box temperature, we might want to have the maximum temperature displayed at 50°F and the minimum value set to 30°F.

Version Info

The Version Info option in the Setup menu displays the product name, serial number, and software version. This information will be displayed on a screen after scrolling to Version Info and pressing Select. Pressing any button will return to the Setup menu.

Factory Reset

The Factory Reset option in the Setup menu allows the user to restore the meter's factory default settings. First scroll to Factory Reset and press Select. Text will appear asking to confirm or cancel the reset request. Press Yes to confirm or No to cancel the reset.

Software Upgrade

The meter firmware can be updated in one of two ways. The first option is to use the Software Upgrade option in the Setup menu. The second option is to force the meter into upgrade mode on startup.

Each method involves using a USB memory stick connected to the USB port on the back of the meter. The USB port is a type A/B micro USB port. This port is also known as a Micro USB Host OTG. Available at Best Buy or Amazon: <http://amzn.com/B00J631SU8>

CAUTION  Removing power or the USB memory stick during the upgrade process will render the meter inoperable.

Both methods are described below:

Upgrade via Software Upgrade Option

Download a new version from <http://www.blueseas.com/m2firmware>.

Copy firmware to a USB Memory Stick. The file name should be image.1841.bin., where 1841 is the PN of the meter. i.e., image.1841.bin, etc.

Remove USB dust cover plug.

Insert memory stick into the USB socket on back of the meter. Note: You may need an adapter dongle to interface between the memory stick and the meter (<http://a.co/6eHeaMK>).

Select Software Upgrade option.

Answer Yes to "Are you sure you want to update the Flash?"

The red LED on the M2 will rapidly flash for about 10 seconds.

If the upgrade was successful, a message with the new software version will be displayed.

If there is an error then a message will be displayed (see error messages below).

Remove USB memory stick.

Replace USB dust cover with "USB" text right side up.

Download a new version from <http://www.blueseas.com/m2>.

Copy firmware to a USB Memory Stick. The file name should be image.1841.bin., where 1841 is the model number of the meter. i.e., image.1841.bin, etc.

Turn off the power to the unit.

Remove USB dust cover plug.

Insert the memory stick into the USB socket on back of the unit. Note: You may need an adapter dongle to interface between the memory stick and the meter: (<http://a.co/6eHeaMK>).

While pressing and holding the leftmost and rightmost keys, turn the power to the meter ON.

The red LED on the M2 will rapidly flash for about 10 seconds.

If the upgrade was successful, a message with the new software version will be displayed.

If there is an error then a message will be displayed (see error message below).

Remove USB memory stick.

Replace USB dust cover with USB label facing up.

Upgrade via Forcing Meter into Upgrade Mode

Upgrade Messages

Flash Successful / SW Version: xxx - Upgrade successful.

File Not Found - A valid flash image was not found on the meter. The downloaded upgrade filename should be image.1841.bin, where xxx is the model number of the meter. i.e., image.1830.bin, image.1841.bin, etc.

Corrupted File - The image is not valid or corrupted. Re-download the updated image from www.blueseas.com.

No USB Device - The USB memory card is not plugged in or the cable is defective.

Wrong Model Number - The image file is for a different meter. Download a new file from www.blueseas.com/m2firmware.

Wrong HW Version - The new image file does not support this revision of hardware.



425 Sequoia Drive
Bellingham, WA 98226 USA

p 360.738.8230
p 800.222.7617 USA and Canada Customer Service
f 360.734.4195
conductor@blueseas.com
www.blueseas.com