

# Renogy

Dual Input DC-DC On-Board with MPPT Battery Charger

12V/24V 50A | IP67

RBC2125DS-21W

VERSION A0  
January 16, 2024

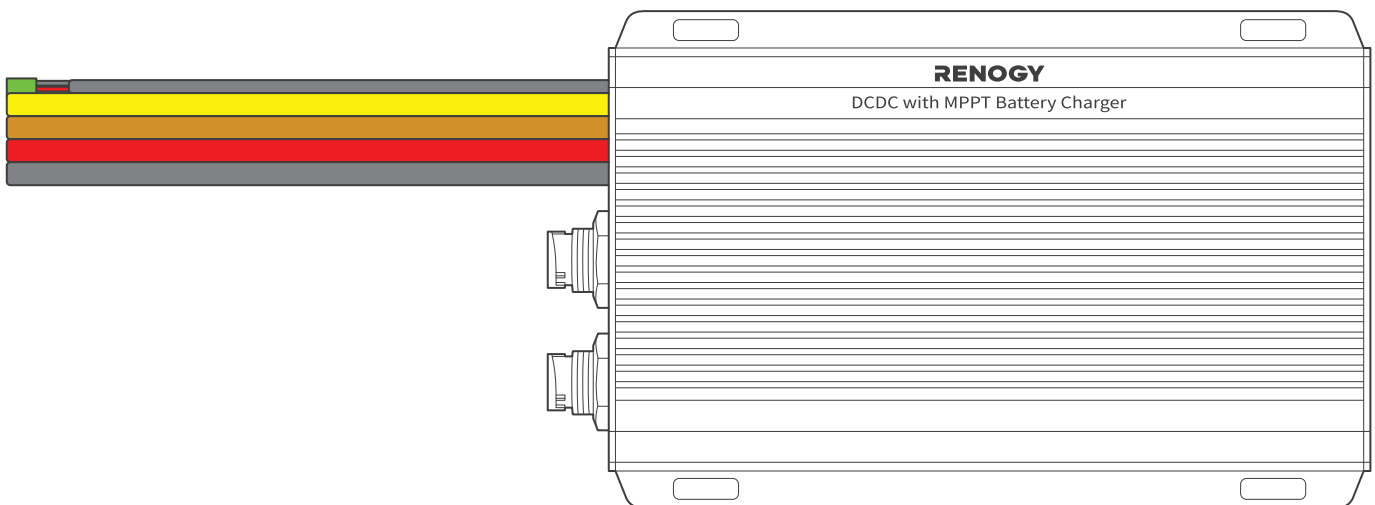

USER MANUAL

## Before Getting Started

The user manual provides important operation and maintenance instructions for Renogy 12V/24V 50A IP67 Dual Input DC-DC On-Board with MPPT Battery Charger (hereinafter referred to as battery charger).

Read the user manual carefully before operation and save it for future reference. Failure to observe the instructions or precautions in the user manual can result in electrical shock, serious injury, or death, or can damage the battery charger, potentially rendering it inoperable.

- Renogy ensures the accuracy, sufficiency, and the applicability of information in the user manual at the time of printing due to continual product improvements that may occur.
- Renogy assumes no responsibility or liability for personal and property losses, whether directly and indirectly, caused by the user's failure to install and use the product in compliance with the user manual.
- Renogy is not responsible or liable for failures, damages, or injuries resulting from repair attempted by unqualified personnel, improper installation, and unsuitable operation.
- The illustrations in the user manual are for demonstration purposes only. Details may appear slightly different depending on product revision and market region.
- Renogy reserves the right to change the information in the user manual without notice. For the latest user manual, visit [renogy.com](https://www.renogy.com).

## Disclaimer

Renogy 12V/24V 50A IP67 Dual Input DC-DC On-Board with MPPT Battery Charger User Manual © 2024 Renogy. All rights reserved.

**RENOGY** and **RENOGY** are registered trademarks of Renogy.

- All information in the user manual is subject to copyright and other intellectual property rights of Renogy and its licensors. The user manual may not be modified, reproduced, or copied, in whole or in part, without the prior written permissions of Renogy and its licensors.
- The registered trademarks in the user manual are the property of Renogy. The unauthorized use of the trademarks is strictly prohibited.

## Online Manual

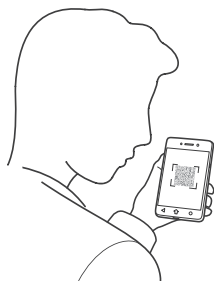

Quick Guide



User Manual



## DC Home App



DC Home App



# Table of Contents

<b>1. General Information</b>	<b>1</b>
1.1. Symbols Used	1
1.2. Introduction	1
1.3. Key Features	1
1.4. SKU	1
<b>2. Get to Know 12V/24V 50A DC-DC Battery Charger with MPPT</b>	<b>2</b>
2.1. What's In the Box?	2
2.2. Product Overview	2
2.3. System Setup	3
<b>3. Preparation</b>	<b>4</b>
3.1. Recommended Tools & Accessories	4
3.2. Size Wires	5
3.3. Plan a Mounting Site	5
3.4. Check the Battery Charger	6
3.5. Check the Auxiliary Battery	7
3.6. Check the Solar Panel(s)	8
3.7. Check the Alternator on Your Automobile	10
3.8. How to Install 15/32 in Lugs or 3/8 in Lugs?	11
3.9. How to Install Cables on the Battery Charger?	12
<b>4. Installation</b>	<b>15</b>
4.1. Wear Insulating Gloves	15
4.2. Connect the Battery Charger to a Busbar	15
4.3. Connect the Battery Charger to an Auxiliary Battery	16
4.4. Connect the Battery Charger to a Solar Panel	17
4.5. Connect the Battery Charger to a Starter Battery	18
4.6. Install a Battery Temperature Sensor	19
4.7. CAN Communication Wiring (Optional)	19
4.8. Wire Inspection	23
<b>5. LED Indicators</b>	<b>24</b>
<b>6. Configuration</b>	<b>25</b>
6.1. Set a Battery Type	25
6.2. User Mode	25
6.3. Configure Charging Parameters	26
6.4. Activate Lithium Batteries	27
<b>7. Monitoring</b>	<b>28</b>
7.1. Short-Range Monitoring	28
7.2. Wireless Long-Range Monitoring	29
7.3. Wired Long-Range Monitoring (Backbone Network)	30
7.4. Wired Long-Range Monitoring (Daisy Chain Network)	31



<b>8. Working &amp; Charging Logic</b>	<b>32</b>
8.1. Automatic Voltage Matching Function	32
8.2. Charging Logic	33
8.3. Battery Charging Stages	35
<b>9. Troubleshooting</b>	<b>37</b>
<b>10. Dimensions &amp; Specifications</b>	<b>39</b>
10.1. Dimensions	39
10.2. Technical Specifications	39
<b>11. Maintenance</b>	<b>40</b>
11.1. Inspection	40
11.2. Cleaning	40
11.3. Storage	40
<b>12. Emergency Responses</b>	<b>41</b>
12.1. Fire	41
12.2. Flooding	41
12.3. Smell	41
12.4. Noise	41
<b>Renogy Support</b>	<b>42</b>



# 1. General Information

## 1.1. Symbols Used

The following symbols are used throughout the user manual to highlight important information.

-  **WARNING:** Indicates a potentially hazardous condition that could result in personal injury or death.
-  **CAUTION:** Indicates a critical procedure for safe and proper installation and operation.
-  **NOTE:** Indicates an important step or tip for optimal performance.

## 1.2. Introduction

Renogy 12V/24V 50A IP67 Dual Input DC-DC On-Board with MPPT Battery Charger allows you to charge your house (auxiliary) battery from solar panels or the starter battery in your RV. It is a charging device that not only converts direct current to the appropriate voltage for charging a battery but also incorporates MPPT (Maximum Power Point Tracking) technology to optimize power conversion from solar panels.

The battery charger is versatile and can be connected to either 12V or 24V auxiliary batteries. The built-in buck converter module is designed to adapt to different voltage requirements, enabling 12V solar panels to charge 24V batteries at their native voltage and 24V solar panels to charge 12V batteries at their native voltage.

Thanks to the exclusive intelligent charging logic, the battery charger prioritizes solar energy and automatically adjusts working modes based on sunlight intensity, efficiently charging your house battery while easing the load on generators. The battery charger seamlessly switches to solar charging in ample sunlight and smoothly transitions to generator charging during low light, ensuring uninterrupted device power.

Equipped with intelligent boost and buck logic, it seamlessly accommodates 12V/24V voltage systems, elevating DIY possibilities to the uttermost. Maximizing energy utilization, it boasts a robust 50A current and an impressive 720W output power, making a slim, waterproof dual charging solution perfect for confined spaces. You can embrace an eco-conscious charging experience without compromising efficiency or space, redefining sustainable energy utilization with the battery charger.

## 1.3. Key Features

- **Intelligent Boost and Buck Logic**  
Effortlessly converts between 12V and 24V systems with over 90% efficiency for boosting and 94% for voltage reduction, offering a dual charging solution adaptable to various DIY configurations.
- **Prioritize Solar Green Energy**  
Features auto-switching charging mode while prioritizing green power, achieving 97% charging efficiency, and delivering 720W high charging power for a greener approach.
- **IP67 Waterproof**  
Ensures robust safety standards with multiple certifications like CE, FCC, and RoHS, guaranteeing a secure off-grid power experience alongside strong IP67 waterproof performance.
- **Extremely Compact and Lightweight**  
Compact and light enough to be mounted in engine compartment and side storeroom, allowing for a more spacious and comfortable living space.
- **Smart Living Unleashed**  
Compatible with both built-in Bluetooth and wired CAN communication to get real-time data, striving for the most reliable experience for off-grid users.

## 1.4. SKU

Renogy 12V/24V 50A IP67 Dual Input DC-DC On-Board with MPPT Battery Charger	RBC2125DS-21W
---	---------------

## 2. Get to Know 12V/24V 50A DC-DC Battery Charger with MPPT

### 2.1. What's In the Box?

Renogy 12V/24V 50A IP67  
Dual Input DC-DC On-Board  
with MPPT Battery Charger x 1

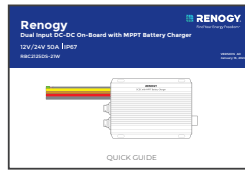
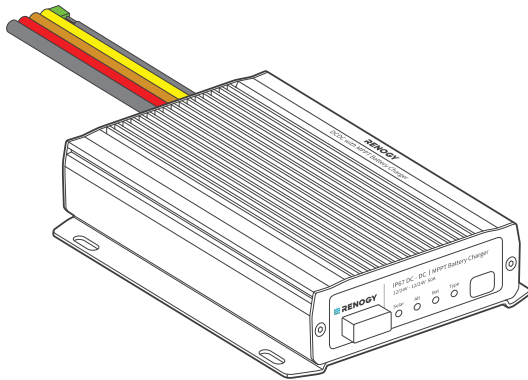

Quick Guide x 1

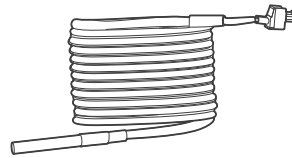

Battery Temperature  
Sensor (3 m) x 1

ST4\*20 mm

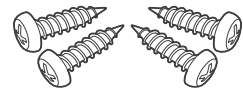

Mounting Screws x 4

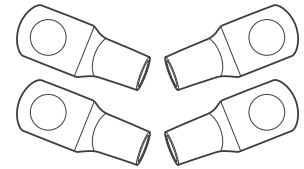

15/32 in Lugs  
(M12 Ring Terminals) x 4

- i** Make sure that all accessories are complete and free of any signs of damage.
- i** The accessories and product manual listed are crucial for the installation, excluding warranty information and any additional items. Please note that the package contents may vary depending on the specific product model.
- i** The 15/32-inch lugs (M12 ring terminals) are used to connect starter battery on your vehicle to your auxiliary battery.

### 2.2. Product Overview

#### ■ Right-side View

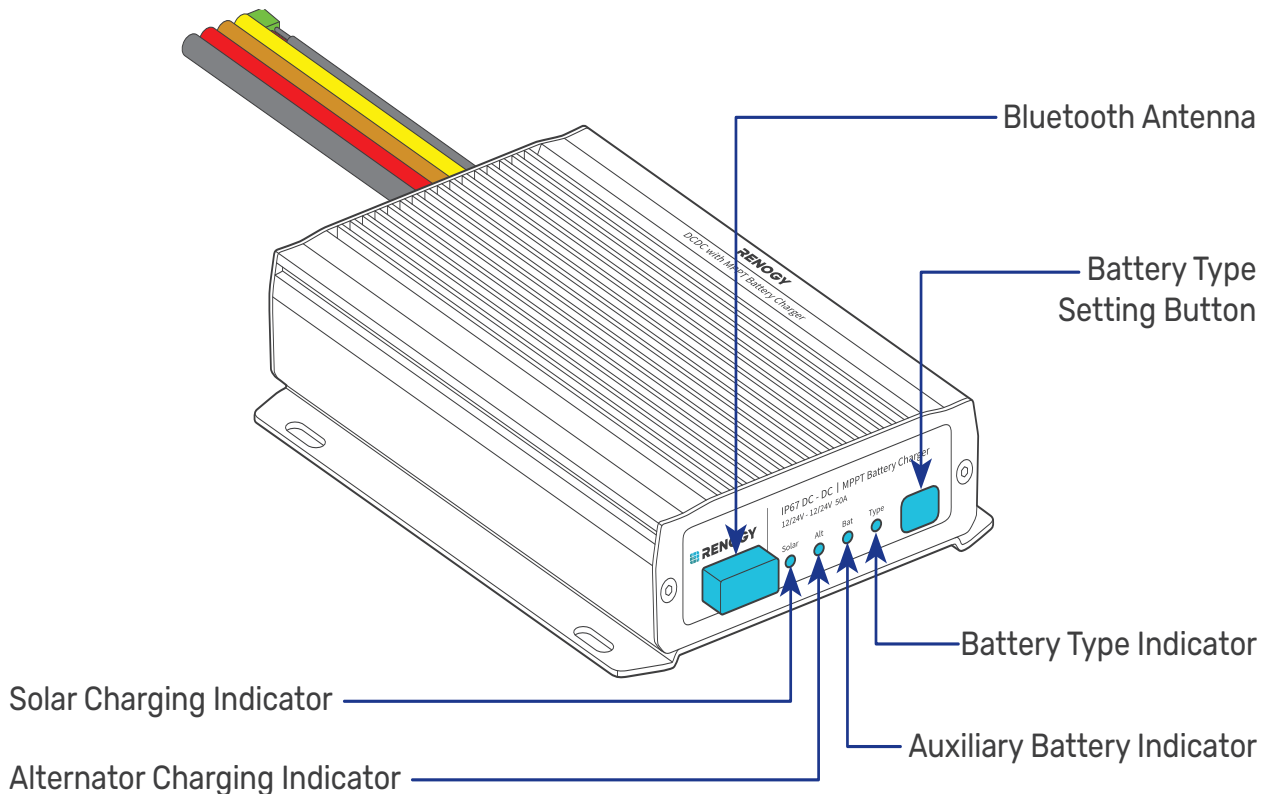

## Left-side View

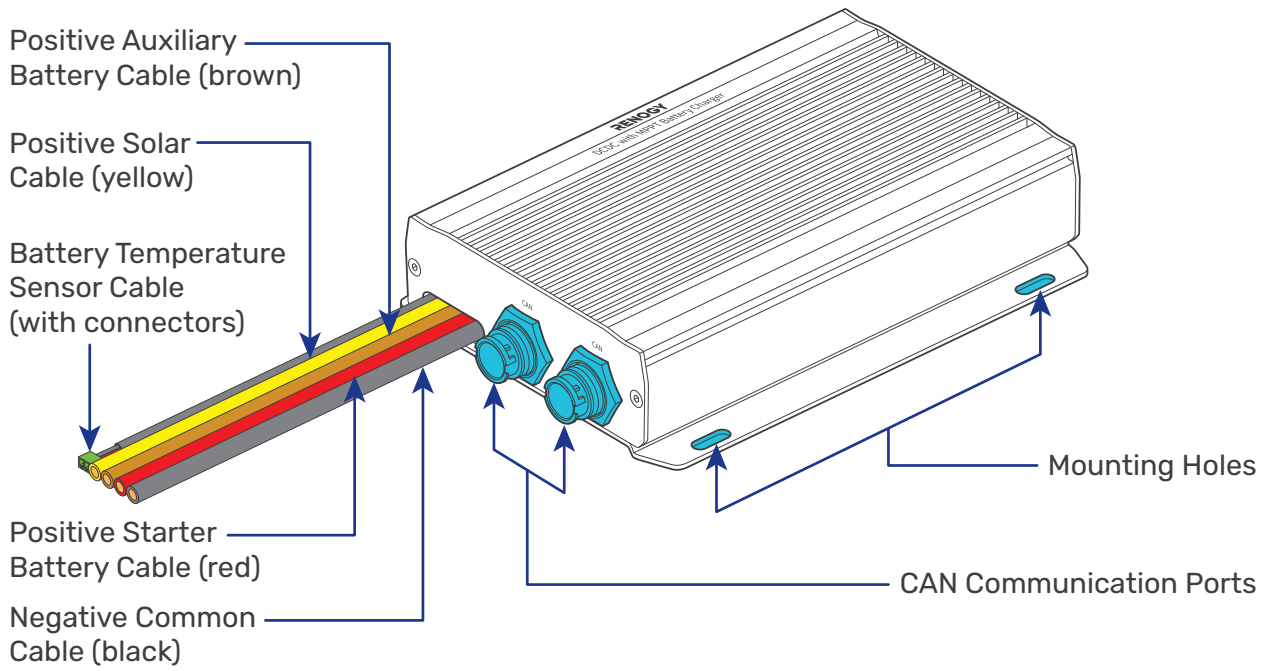

## 2.3. System Setup

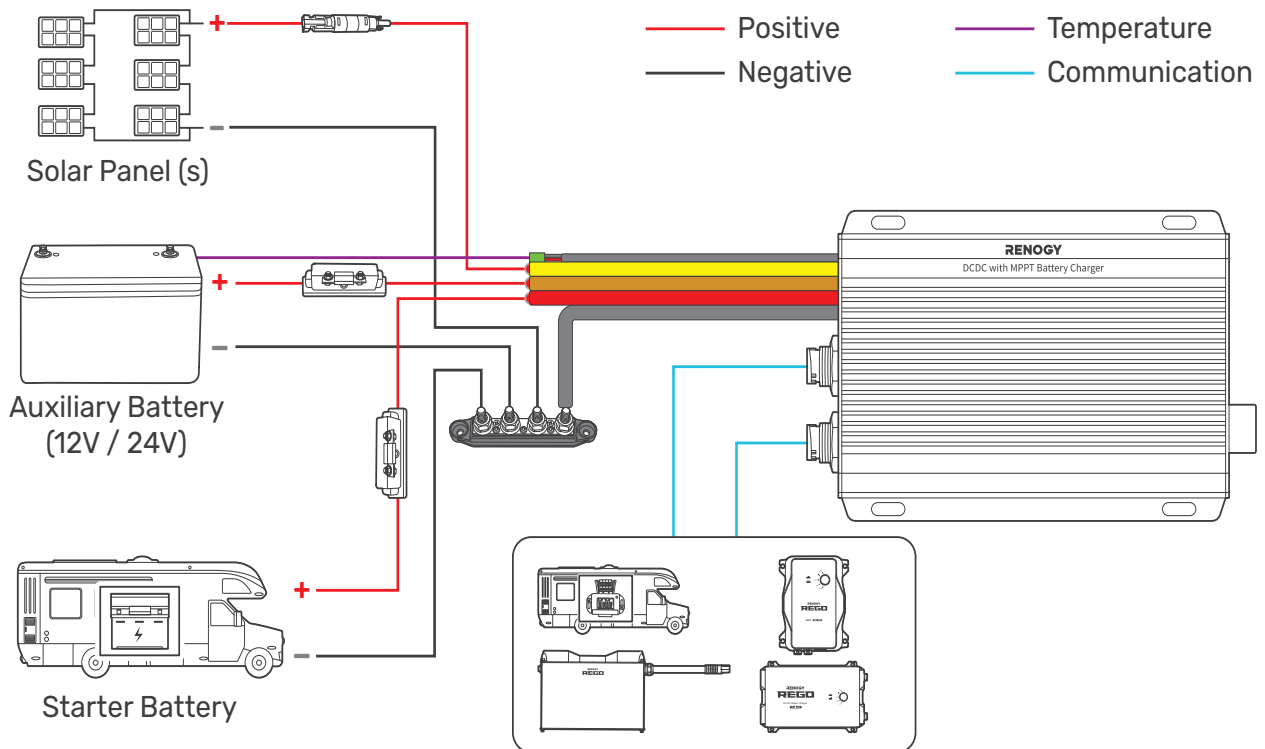

**i** The wiring diagram only shows the key components in a typical DC-coupled off-grid energy storage system for the illustrative purpose. The wiring might be different depending on the system configuration. Additional safety devices, including disconnect switches, emergency stops, and rapid shutdown devices, might be required. Wire the system in accordance with the regulations at the installation site.

**i** The battery charger can be connected separately to the solar panel for charging the auxiliary battery or to the vehicle's starting battery for charging the auxiliary battery.

## 3. Preparation

### 3.1. Recommended Tools & Accessories



Phillips  
Screwdriver (#1)

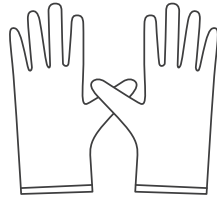

Insulating Gloves

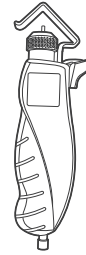

Wire stripper

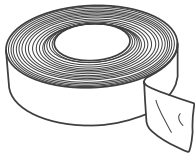

Insulation Tape

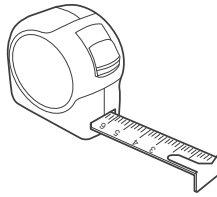

Measuring Tape

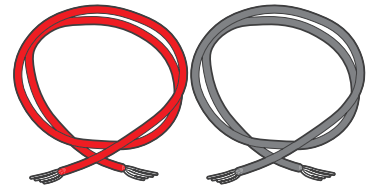

Bare Wires

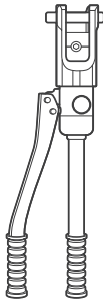

Manual Hydraulic Pliers

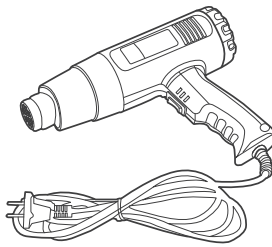

Heat Gun

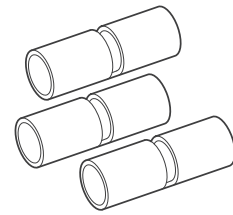

Butt-Splices

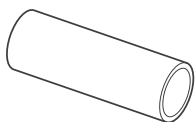



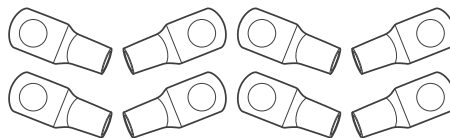

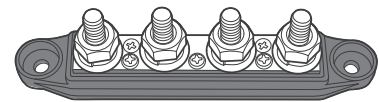

Heat Shrink Tubing



3/8 in Lugs (M10 Ring Terminals)



Busbar (60A to 100A)

-  Prior to installing and configuring the battery charger, prepare the recommended tools, components, and accessories.
-  Choose proper mounting screws specific to your installation site. This manual takes self-tapping screws for wooden walls as an example.
-  The 3/8-inch lugs (M10 ring terminals) are used to connect the busbar and ANL fuse.
-  For how to size bare wires, refer to [“3.2. Size Wires”](#) in this manual.
-  In this manual, the red cable represents the positive cable, and the gray cable represents the negative cable.
-  Do not use the bare wire if there is any visible damage.

### 3.2. Size Wires

Select proper bare wires based on the cable length in your power system. Refer to the table below for recommended gauge sizes.

Cable	Cable Length	Cable Gauge Size
Output (to Auxiliary Battery)	0 ft to 10 ft (0 m to 3 m)	10 AWG (5.25 mm <sup>2</sup> )
	11 ft to 20 ft (3 m to 6 m)	8 AWG (8.36 mm <sup>2</sup> )
	21 ft to 30 ft (6 m to 9 m)	6 AWG (13.3 mm <sup>2</sup> )
Input (from Starter Battery)	0 ft to 10 ft (0 m to 3 m)	10 AWG (5.25 mm <sup>2</sup> )
	11 ft to 20 ft (3 m to 6 m)	8 AWG (8.36 mm <sup>2</sup> )
	21 ft to 30 ft (6 m to 9 m)	6 AWG (13.3 mm <sup>2</sup> )
Input (from Solar Panel)	0 ft to 10 ft (0 m to 3 m)	12 AWG (3.31 mm <sup>2</sup> )
	11 ft to 20 ft (3 m to 6 m)	10 AWG (5.25 mm <sup>2</sup> )
	21 ft to 30 ft (6 m to 9 m)	10 AWG (5.25 mm <sup>2</sup> )

- i** The cable specifications listed above account for critical, less than 3% voltage drop and may not account for all configurations.
- i** The specification of fuse cable is consistent with the input or output terminal of the battery charger.







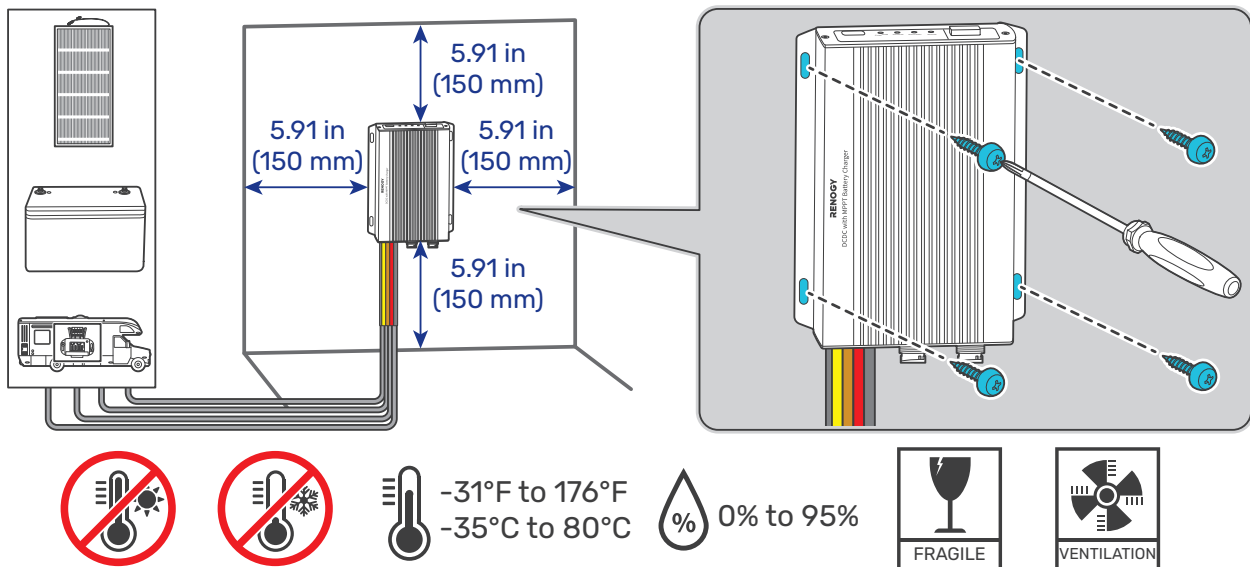

### 3.3. Plan a Mounting Site

The battery charger requires adequate clearance for installation, wiring and ventilation. The minimum clearance is provided below. Ventilation is highly recommended if it is mounted in an enclosure. Select a proper mounting site to ensure the battery charger can be safely connected to the battery, solar panel(s), and the other necessary devices with the relevant cables.

You can mounting the battery charger vertically on a wall or horizontally on the floor.







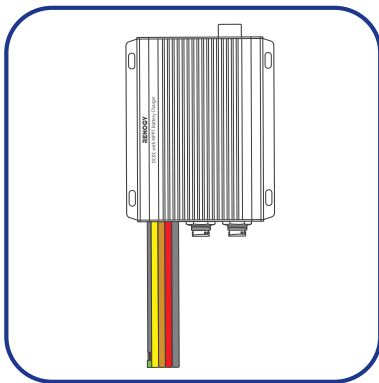

- ⚠** Risk of explosion! Never install the battery charger in a sealed enclosure with flooded batteries! Do not install the battery charger in a confined area where battery gases can accumulate.
- ⚠** The battery charger should be installed on a flat surface protected from direct sunlight.
- ⚠** Keep the battery charger out of the reach of children and animals.

-  Do not expose the battery charger to flammable or harsh chemicals or vapors.
-  Make sure that the battery charger is installed in a place at ambient temperature from -31°F to 176°F (-35°C to 80°C).
-  Make sure that the battery charger is installed in an environment with relative humidity between 0% and 95% and no condensation.
-  If the battery charger is installed improperly on a boat, it may cause damage to components of the boat. Have the battery charger by a qualified electrician.
-  The battery charger should be as close to the battery as possible to avoid voltage drop due to long cables.
-  It is recommended that all cables (except communication cables) should not exceed 10 meters (32.8 feet) because excessively long cables result in a voltage drop. The communication cables should be shorter than 6 m (19.6 feet).
-  The cable specifications listed in the user manual account for critical, less than 3% voltage drop and may not account for all configurations.
-  Keep the battery charger away from EMI receptors such as TVs, radios, and other audio/visual electronics to prevent damage or interference to the equipment.

### 3.4. Check the Battery Charger



Inspect the battery charger for any visible damage including cracks, dents, deformation, and other visible abnormalities. All connector contacts shall be clean, free of dirt and corrosion, and dry.

-  Do not use the battery charger if there is any visible damage.
-  Do not puncture, drop, crush, penetrate, shake, strike, or step on the battery charger.
-  There are no serviceable parts in the battery charger. Do not open, dismantle, repair, tamper with, or modify the battery charger.
-  Confirm the polarities of the devices before connection. A reverse polarity contact can result in damage to the battery charger and other connected devices, thus voiding the warranty.
-  Do not touch the connector contacts while the battery charger is in operation.
-  Wear proper protective equipment and use insulated tools during installation and operation. Do not wear jewelry or other metal objects when working on or around the battery charger.
-  Do not dispose of the battery charger as household waste. Comply with local, state, and federal laws and regulations and use recycling channels as required.

### 3.5. Check the Auxiliary Battery

#### Recommended Components & Accessories

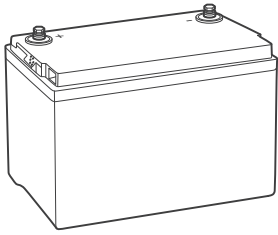

\*12V/24V Battery (11V to 32V)

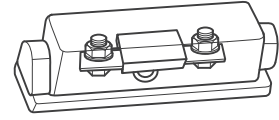

\*ANL Fuse (60A) × 1

**i** Components and accessories marked with “\*” are available on [renogy.com](http://renogy.com).

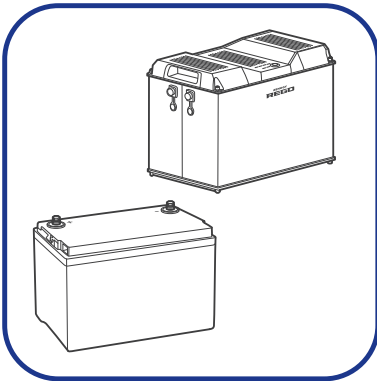

1. Inspect the battery for any visible damage including cracks, dents, deformation, and other visible abnormalities. All terminals shall be clean, free of dirt and corrosion, and dry.

The battery charger can only be connected to 12V or 24V deep-cycle gel-sealed lead-acid batteries (GEL), flooded lead-acid batteries (FLD), sealed lead-acid batteries (SLD/AGM) or lithium iron phosphate batteries (LI).

- !** Do not use the battery if there is any visible damage. Do not touch the exposed electrolyte or powder if the battery housing is damaged.
- !** When being charged, the battery may give off explosive gas. Make sure there is good ventilation.
- !** Take care to use a high-capacity lead-acid battery. Be sure to wear protective goggles. If carelessly getting electrolyte in your eyes, flush your eyes with clean water immediately.
- ⚡** Combine batteries in parallel or in series as needed. Prior to installing the battery charger, ensure all battery groups are installed properly.
- i** Read the user manual of the battery in use carefully.

Battery or Battery Bank System Voltage	
Battery or Battery Bank System Voltage = System Voltage U	
Batteries in Series	Batteries in Parallel
System Voltage U: $U_1+U_2+U_3$	System Voltage U: $U_1=U_2=U_3$

2. This battery charger works seamlessly with both 12V and 24V battery systems. Please consult the battery manual for accurate system voltage information. Ensure that the 16V overvoltage protection is not triggered for 12V systems and the 32V protection is not activated for 24V systems.

Read the battery user manual for battery voltage parameters, and calculate the voltage of the battery or battery pack system according to the formula to ensure that it does not exceed 32V.

**i** In the formula, U represents the battery voltage, and 1, 2, or 3 represents the battery number respectively.



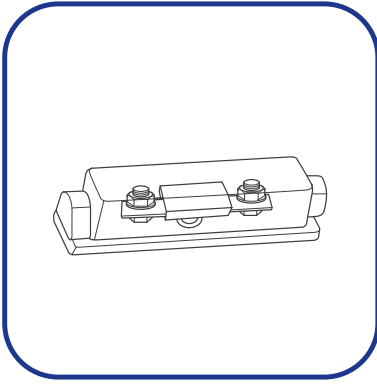

3. Inspect the ANL Fuses for any visible damage including cracks, dents, deformation, and other visible abnormalities. All terminals shall be clean, free of dirt and corrosion, and dry.



Do not use the ANL Fuses if there is any visible damage.



For details on how to install and use the ANL Fuse, see its user manual.

### 3.6. Check the Solar Panel(s)

#### Recommended Components & Accessories

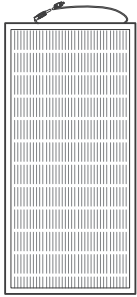

\*Solar Panel (s)

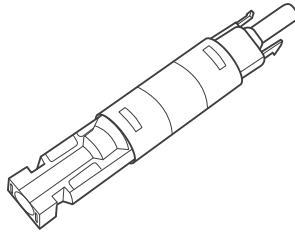

\*Solar Panel Fuse

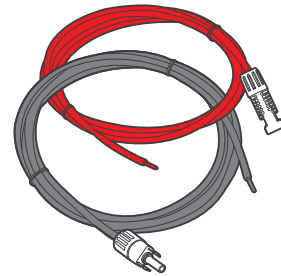

\*Solar Panel Extension Cables × 2



Components and accessories marked with "\*" are available on [renogy.com](https://renogy.com).



For how to size solar panel extension cables, refer to "[3.2. Size Wires](#)" in this manual.

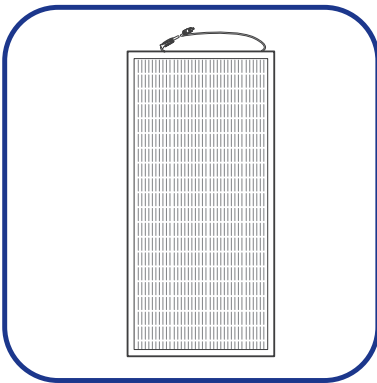

1. Inspect the solar panel for any visible damage including cracks, dents, deformation, and other visible abnormalities. All connector contacts shall be clean, dry, and free of dirt and corrosion.



Do not use the solar panel if there is any visible damage.



Cover the solar panel prior to connecting it to the battery charger to prevent any electrical current or voltage from being generated or flowing through the system during the installation process. This reduces the risk of electrical shocks or accidents while making connections, ensuring the safety of the installer and the integrity of the equipment.



Do not install the solar panel on a surface constructed from combustible material.



Do not expose the solar panel to direct flame or heat sources.









Keep the solar panel out of the reach of children.



Keep the solar panel away from explosives and corrosive substances.



-  Do not step, walk, stand, or jump on the solar panel. Localized heavy loads may cause damage to the solar cells, which will ultimately compromise the performance of the solar panel.
-  Do not bend the solar panel. Bending the solar panel will cause damage to the cells and affect panel performance.
-  Do not immerse the solar panel in water.
-  Read the user manual of the solar panel carefully before installation.
-  The solar panels can be combined in parallel or in series as needed.
-  Identify the polarities (positive and negative) on the cables used for solar panels. A reverse polarity contact may damage the unit.

Maximum Output Power	
Maximum Output Power of Solar Panel or Solar Panel Array = Maximum Solar Input Power W	
Solar Panels in Series	Solar Panels in Parallel
Maximum Output Power W: $W_1+W_2+W_3$	Maximum Output Power W: $W_1+W_2+W_3$

2. Read the user manual of the solar panel for the maximum output power, and calculate the maximum output power of solar panel or solar panel array according to the formula. Ensure that the maximum output power of the solar panel/solar panel array does not exceed 720W.

 In the formula, W represents the output power of the solar panel, and 1, 2, or 3 represents the solar panel number respectively.

Open Circuit Voltage	
Open Circuit Voltage of Solar Panel or Solar Panel Array = Open Circuit Voltage U	
Solar Panels in Series	Solar Panels in Parallel
Working Voltage U: $U_1+U_2+U_3$	Working Voltage U: $U_1=U_2=U_3$

3. Read the user manual of the solar panel for the maximum open circuit voltage, and calculate the maximum open circuit voltage of solar panel or solar panel array according to the formula. Ensure that the open circuit voltage of the solar panel/solar panel array does not exceed 50V.

 In the formula, 1, 2, or 3 represents the solar panel number respectively.

Short Circuit Current (Isc)	
Short Circuit Current (Isc) of Solar Panel or Solar Panel Array = Short Circuit Current (Isc) I	
Solar Panels in Series	Solar Panels in Parallel
Short Circuit Current (Isc) I: $I_1=I_2=I_3$	Short Circuit Current (Isc) I: $I_1+I_2+I_3$

4. Read the user manual of the solar panel for the short circuit current (Isc), and calculate the short circuit current (Isc) of solar panel or solar panel array according to the formula.

 In the formula, I represents the short circuit current (Isc) of the solar panel, and 1, 2, or 3 represents the solar panel number respectively.

 Short circuit current is the abnormal flow of electric current in a power system, occurring between phases or between phase and ground (or neutral) during operation, with values often exceeding the rated current and dependent on the electrical distance from the short-circuit point to the power source. For detailed information, please refer to the specific solar panel manual.

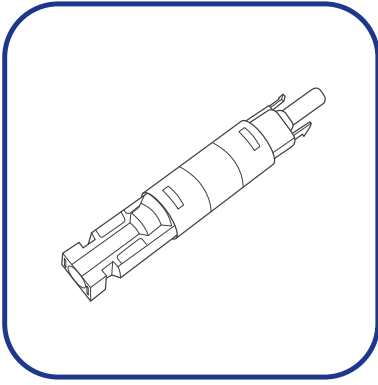

5. The appropriate current rating for the solar panel fuse should be determined by multiplying the total short current amperage of the solar panel array by 1.56.

Rated Current of the Solar Panel Fuse = Short Circuit Current (Isc) of Solar Panel x 1.56

Inspect the solar panel fuse for any visible damage including cracks, dents, deformation, and other visible abnormalities. All terminals shall be clean, free of dirt and corrosion, and dry.



Do not use the solar panel fuse if there is any visible damage.



For details on how to install and use the solar panel fuse, see its user manual.

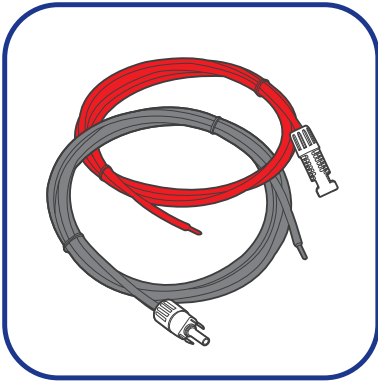

6. Inspect the Solar Panel Extension Cables for any visible damage including cracks, dents, deformation, and other visible abnormalities. All connector contacts shall be clean, dry, and free of dirt and corrosion.



Do not use the solar panel extension cables if there is any visible damage.

### 3.7. Check the Alternator on Your Automobile

#### Recommended Components

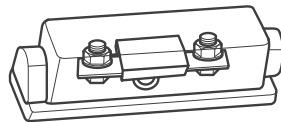

\*ANL Fuse (70A) × 1



Accessories marked with "\*" are available on [renogy.com](https://www.renogy.com).

The automobile alternator may be a smart alternator or a traditional alternator. The connection method of a smart alternator or a traditional alternator depends on its parameters. Before installing the battery charger, read the user manual of the vehicle or consult the vehicle supplier to determine the type of alternator.

In addition, you can use a multimeter by yourself to measure the alternator to determine the type of alternator.

1. Locate your main vehicle battery or the starter battery.
2. Start the engine. Ensure all any fans, radio, lights, and others are turned off.
3. Take a voltage reading across the main vehicle battery.
4. Leave the engine run for around 5 or 10 minutes, then repeat Step 3.

Taking a 12V system as an example, if the vehicle's starter battery is 24V, the following parameters should be multiplied by 2.

Readings around 14.4V DC indicates you most likely have a traditional alternator. If your readings are around 12.5-13.5V, you most likely have a smart alternator.

**!** In general, the working voltage of a traditional alternator ranges from 13.2V to 16V, and that of a smart alternator ranges from 12V to 16V. Consult the vehicle supplier for help if necessary.

### 3.8. How to Install 15/32 in Lugs or 3/8 in Lugs?

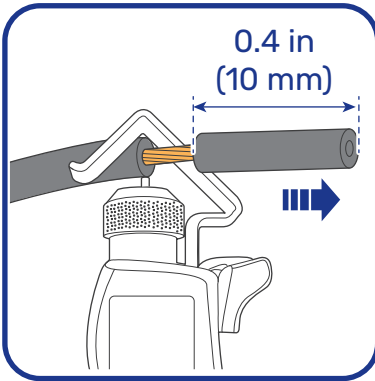

**Step 1:** Strip approximately 0.4 inches (10 mm) of insulation from the end of a bare wire using a wire stripper.



**Step 2:** Thread the exposed bare wire through a piece of heat shrink tubing.

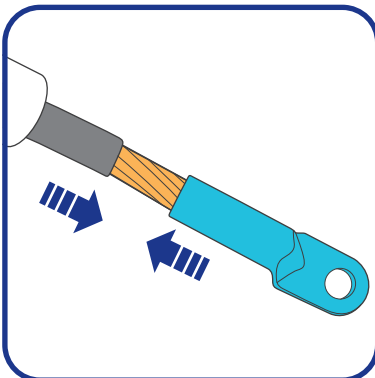

**Step 3:** Attach a 15/32-inch lug or 3/8-inch lug onto the end of the bare wire.

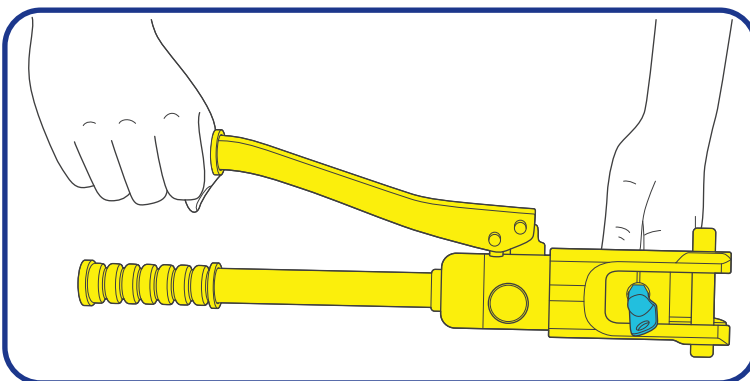

**Step 4:** Securely crimp the lug onto the bare wire using a manual hydraulic pliers.

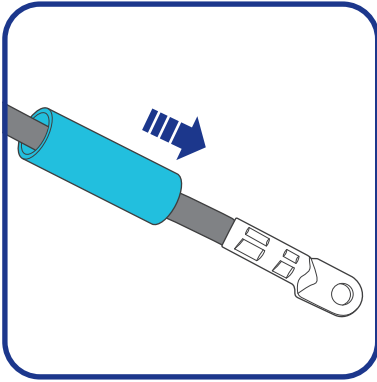

**Step 5:** Slide the heat shrink tubing over the 15/32-inch lug or 3/8-inch lug.

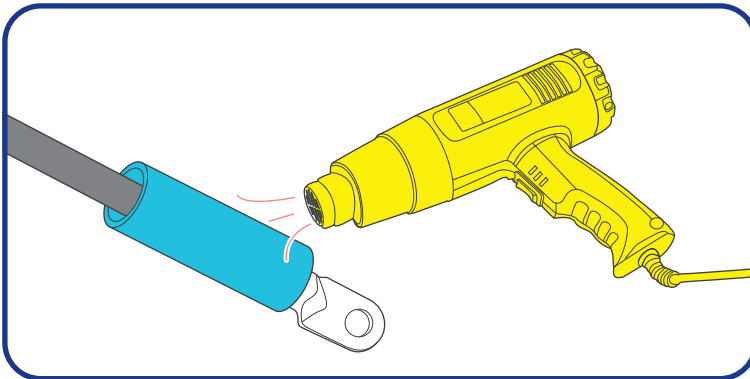

**Step 6:** Apply heat to the heat shrink tubing using a heat gun until it shrinks and forms a tight seal.

### 3.9. How to Install Cables on the Battery Charger?

**!** You are allowed to make connections using insulated conduit, junction boxes, or welding methods. If the battery charger is installed outdoors, please ensure that the wiring connections are waterproof.

#### ■ Positive Cable

The illustrations are based on the Positive Auxiliary Battery Cable. The butt-splice connectors we use in the manual come in separate butt-splices and heat shrink tubings.

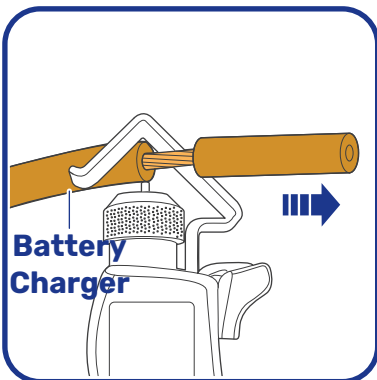

**Step 1:** Wear insulating gloves before wiring. Remove some insulation from the end of the Positive Auxiliary Battery Cable based on the length of the but-splice with a wire stripper.

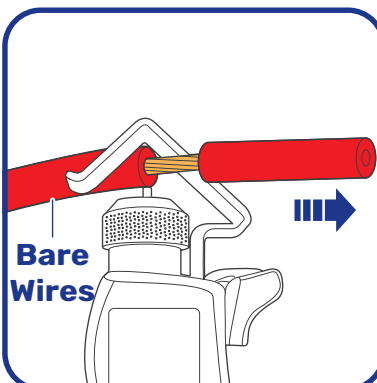

**Step 2:** Remove some insulation from one end of a bare wire based on the length of the but-splice with a wire stripper.

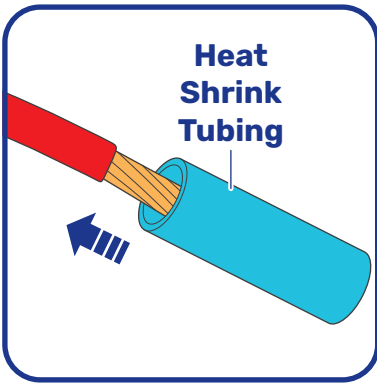

**Step 3:** Thread the exposed bare wire through a piece of heat shrink tubing.

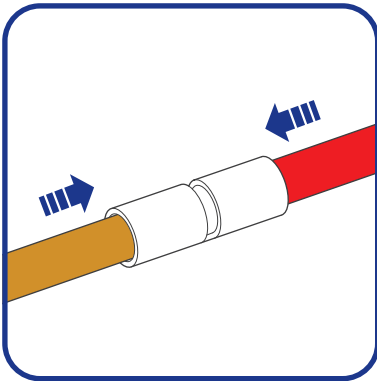

**Step 4:** Insert the Positive Auxiliary Battery Cable and bare wire into the butt-splices.

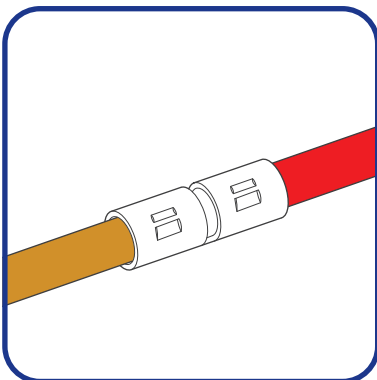

**Step 5:** Securely crimp the butt-splices onto the cables using a manual hydraulic pliers.



You can solder the wires to the butt-splice, ensure that a good connection is made.

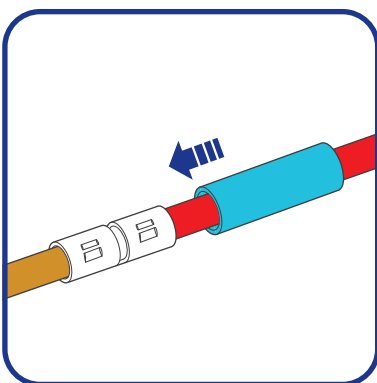

**Step 6:** Slide the heat shrink tubing over the butt-splices.

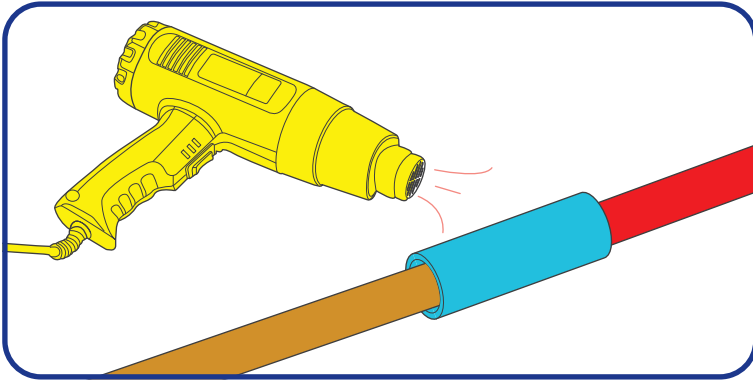

**Step 7:** Apply heat to the heat shrink tubing using a heat gun until it shrinks and forms a tight seal.

### ■ Negative Cable

For the negative terminals, we recommend a busbar. Install the 3/8-inch lugs (M10 ring terminals) on the solar panel, auxiliary battery, starter battery negative cables, and battery charger negative common cable (black) on the busbar.

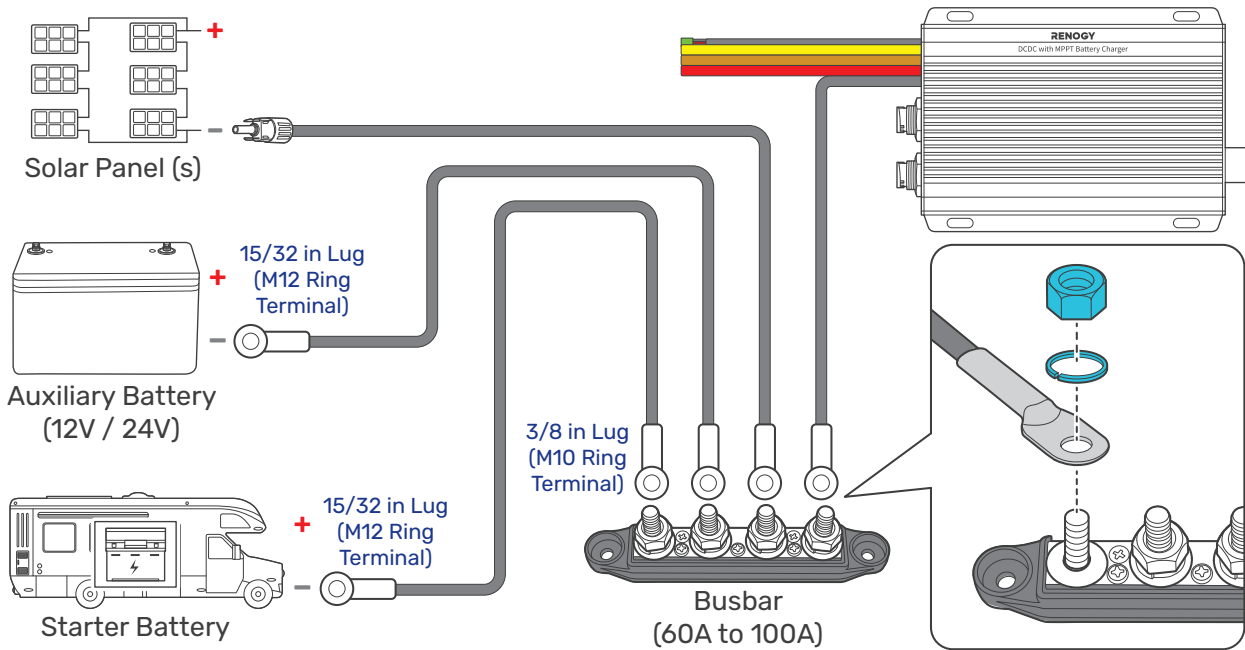

## 4. Installation

To ensure safe and efficient operation of the battery charger and to avoid potential damage or hazards, always follow the installation instructions in the sequence described in this manual.

### 4.1. Wear Insulating Gloves

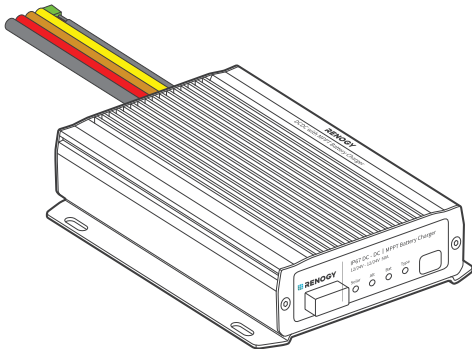

Insulating Gloves

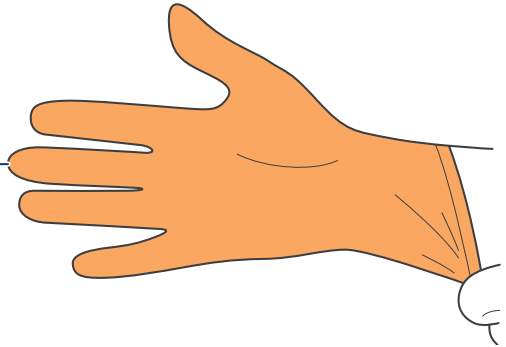

### 4.2. Connect the Battery Charger to a Busbar

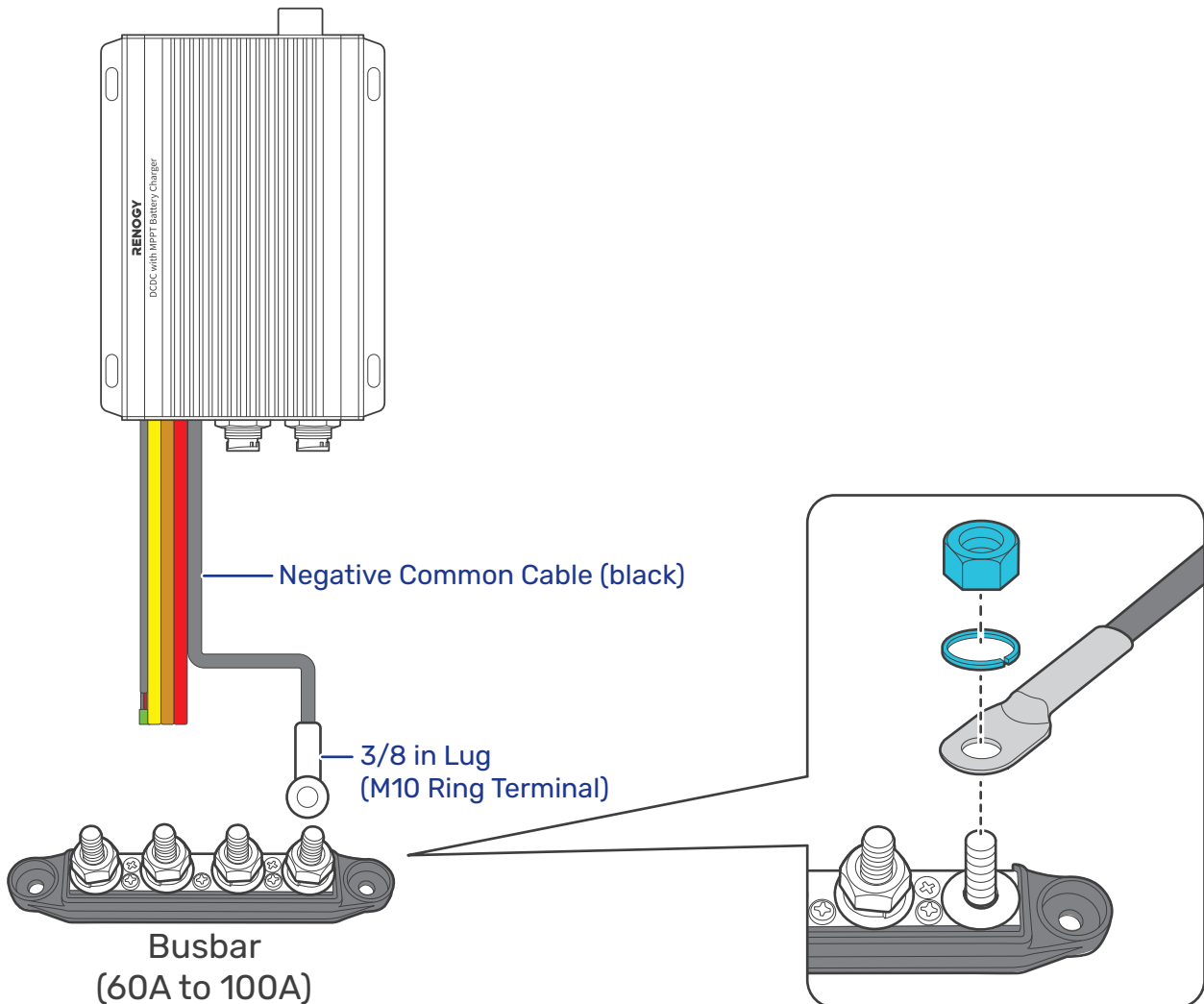

**i** Tug on cable to ensure firm connection.

### 4.3. Connect the Battery Charger to an Auxiliary Battery

The battery charger can only be connected to 12V or 24V deep-cycle gel-sealed lead-acid batteries (GEL), flooded lead-acid batteries (FLD), sealed lead-acid batteries (SLD/AGM) or lithium iron phosphate batteries (LI).

**Step 1:** Connect one positive cable (red) to the Positive Auxiliary Battery Cable (brown) on the battery charger.

**Step 2:** Connect the other end of the positive cable (red) to an ANL fuse.

**Step 3:** Connect the negative cable (gray) to the Busbar, connect the other end to the negative end of an auxiliary battery.

**Step 4:** Connect the ANL fuse to the positive end of the auxiliary battery through the other positive cable (red).

#### STEP-1 Install cables on the battery charger

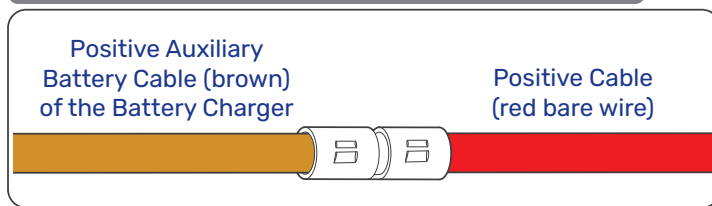

#### STEP-2 Install an ANL fuse

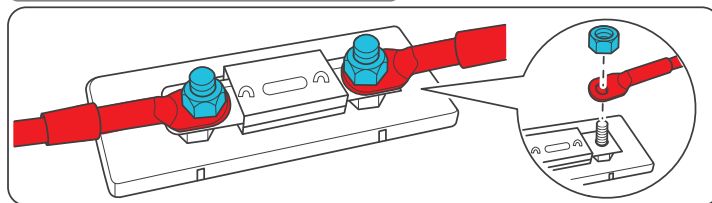

#### STEP-3 Install the cables on the battery

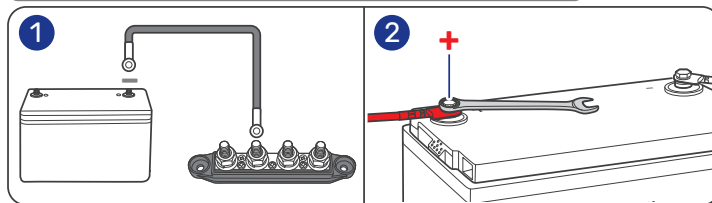

**i** Tug on all cables to ensure firm connection.

**⚡** Always connect the battery charger to a battery before connecting it to a solar panel to ensure safe and efficient operation.



## 4.4. Connect the Battery Charger to a Solar Panel

Choose proper solar panels based on your power system. Connecting the battery charger to a solar panel exceeding 720W ( $\leq 50V$ ) results in damage to the battery charger.

**Step 1:** Connect the positive Solar Panel Extension Cable to the Positive Solar Cable (yellow) on the battery charger.

**Step 2:** Connect the other end of the positive Solar Panel Extension Cable to a solar panel fuse.

**Step 3:** Connect the negative Solar Panel Extension Cable to the Busbar, connect the other end to the negative end of a solar panel.

**Step 4:** Connect the solar panel fuse to the positive end of the solar panel.

### STEP-1 Install cables on the battery charger

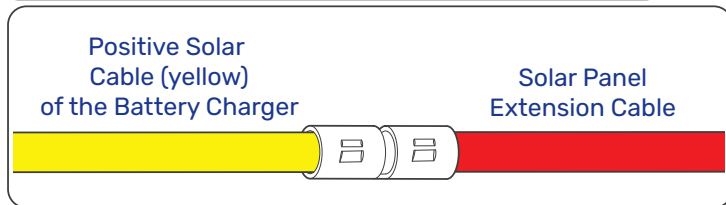

### STEP-2 Install a solar panel fuse

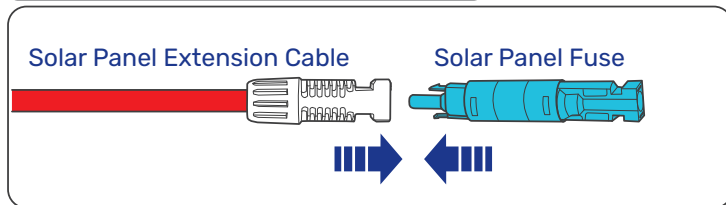

### STEP-3 Install the cables on the solar panel

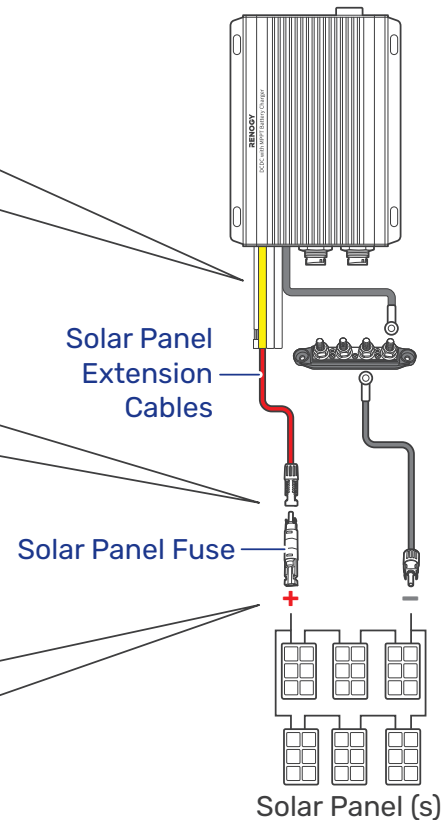
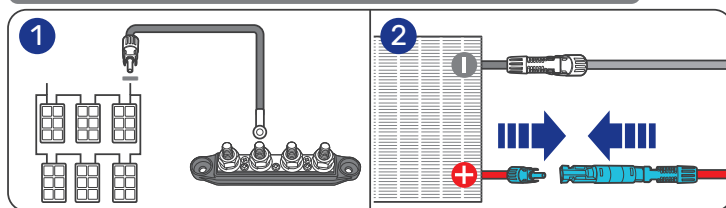

**i** Tug on all cables to ensure firm connection.

## 4.5. Connect the Battery Charger to a Starter Battery

Before installing the charger, consult your vehicle's user manual or contact the vehicle manufacturer to ensure that the output current ranges from 75A to 100A.

The starter battery stops charging the auxiliary battery when the starter battery voltage drops below 12.7V for 12V systems or 25.4V for 24V systems.

**Step 1:** Connect one positive cable (red) to the Positive Starter Battery Cable (red) on the battery charger.

**Step 2:** Connect the other end of the positive cable (red) to an ANL fuse (70A).

**Step 3:** Connect the negative cable (gray) to the Busbar, connect the other end to the negative end of your starter battery.

**Step 4:** Connect the ANL fuse to the positive end of the starter battery through another positive cable (red).

### STEP-1 Install cables on the battery charger

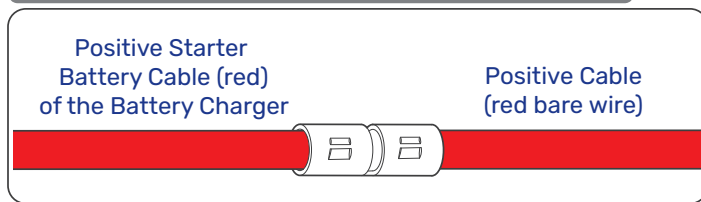

### STEP-2 Install an ANL fuse

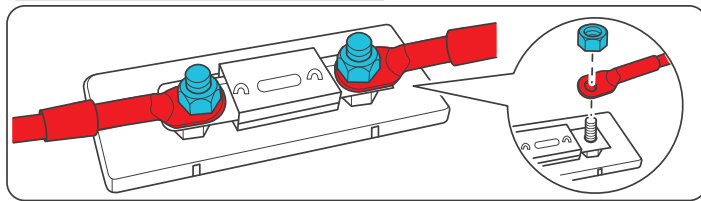

### STEP-3 Install the cables on the RV starter battery

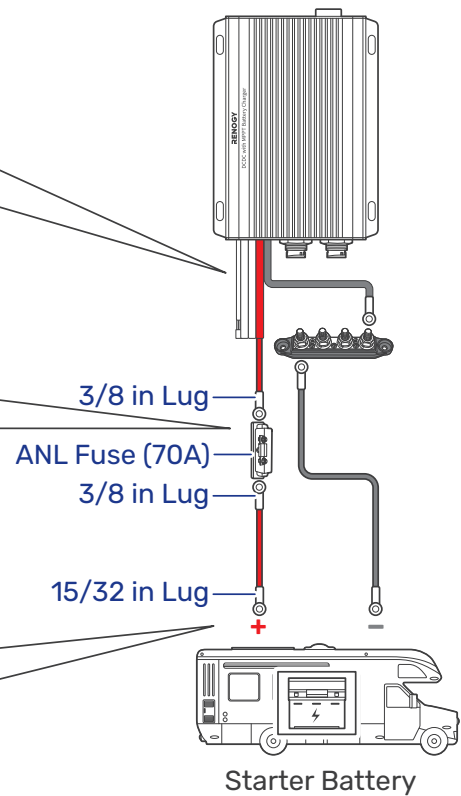
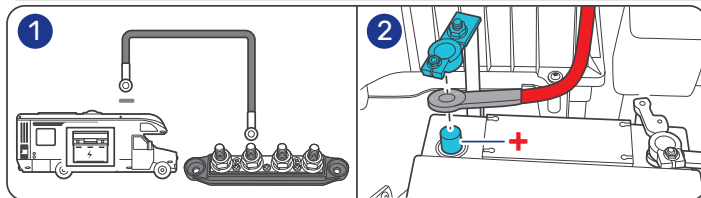

**i** Tug on all cables to ensure firm connection.

## 4.6. Install a Battery Temperature Sensor

The temperature sensor measures the surrounding temperature of the battery and compensates the floating charge voltage when the battery temperature is low.

**Step 1:** Connect the battery temperature sensor to the Battery Temperature Sensor Cable on the battery charger.

**Step 2:** Mount the other end of the sensor securely at a suitable location in close proximity to the battery.

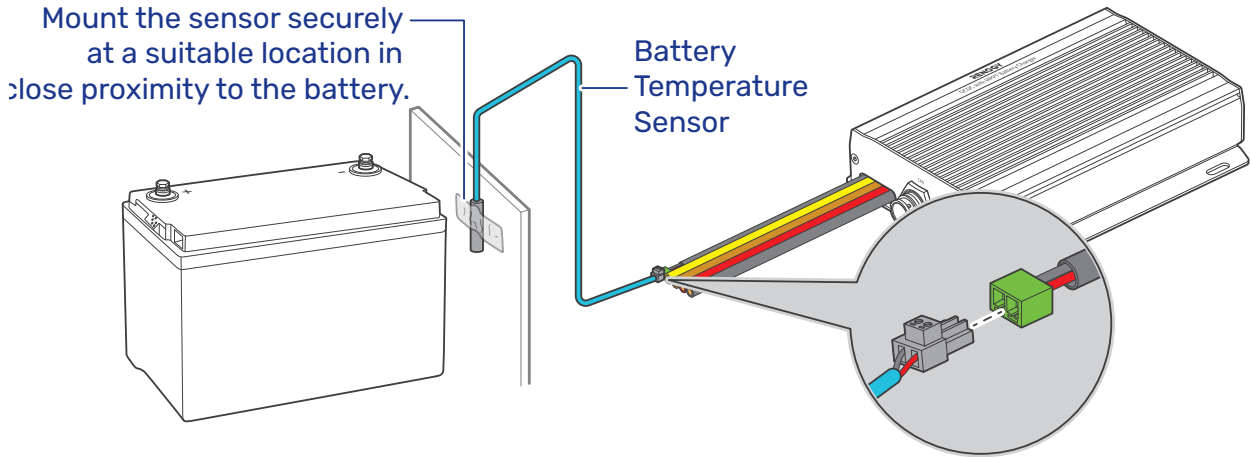

Do not use the temperature sensor on a LiFePO4 (LFP) battery which comes with a battery management system (BMS).

## 4.7. CAN Communication Wiring (Optional)

The 12V/24V 50A IP67 Dual Input DC-DC On-Board with MPPT Battery Charger can communicate with other Renogy devices supporting CAN communication and monitoring devices through CAN (common area network) bus, also known as RV-C, enabling safe operation, smart control, remote monitoring, and programmable settings.

You can connect the battery charger to other Renogy devices supporting CAN communication for real-time inter-device data communication through either of the CAN Communication Ports. 7-Pin CAN Communication Terminal Plugs and 7-Pin CAN Communication Terminal Plug adapter cables are required for the wiring.

The wiring details vary depending on the wiring schemes. This user manual elaborates on inter-device wiring in two schemes: backbone and daisy chain.



For technical support from Renogy, please contact us through [renogy.com/contact-us/](https://renogy.com/contact-us/).

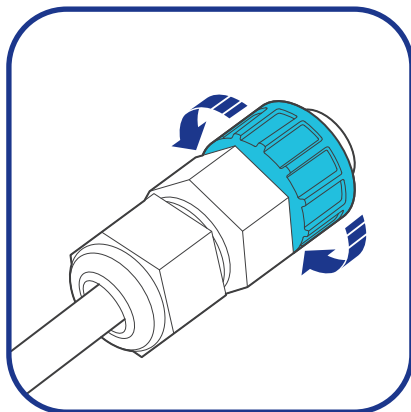

To properly connect or disconnect the 7-Pin CAN Communication Terminal Plug to or from the battery charger, you should

1. Ensure that the plug is oriented vertically toward the CAN Communication Port.
2. Rotate the terminal fixing nut to loosen or secure the plug.

Shaking the terminal plug while plugging or unplugging it is not allowed.

### ■ Backbone Network

Ensure 120Ω terminating resistors are installed at both ends of the RV-C bus for successful communication with Renogy devices supporting CAN communication. If the RV user manual does not determine if the RV-C bus has a built-in 120Ω termination resistor, call the RV manufacturer to confirm.

**i** If the RV-C bus does not have a built-in 120Ω termination resistor, the battery charger will not communicate properly with other Renogy devices supporting CAN communication. Please use the Daisy Chain Network for communication connections.

Connect devices to the battery charger according to the wiring diagram provided by the RV manufacturer. Choose proper communication cables according to your specific demands.

### Recommended Tools & Accessories

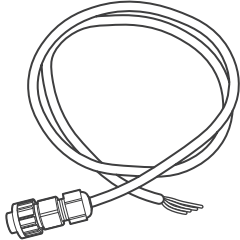

\*7-Pin CAN Communication Terminal Plug to Bare Drop Cable(s)

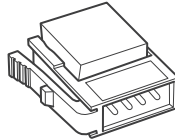

Drop Plugs

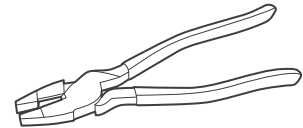

Split Joint Pliers

**i** Accessories marked with "\*" are available on [renogy.com](https://www.renogy.com).

**i** The 7-Pin CAN Communication Terminal Plug to Bare Drop Cable is only for use with the battery charger. Please refer to the user manual of other devices for the communication cable types they require.

**i** The drop cable shall not exceed 19.6 feet (6 m), and the RV-C bus shall not exceed 98.4 feet (30 m).

**i** Choose the appropriate drop plugs that are compatible with the drop sockets used on the RV-C bus. Different RV manufacturers may use different types of drop sockets for inter-device communication connections. If you are unsure about the correct drop plug selection, consult with the RV manufacturer. In this manual, the Mini-Clamp II plug (4-pin) is used as an example.

**i** Different Drop Plugs follow different pinouts. Crimp the Drop Plugs on the Drop Cables following the correct pinout. If you are not sure about the Drop Plug pinout, check with the RV manufacturer.

**Step 1:** Install the Drop Plugs on the bare end of the 7-Pin CAN Communication Terminal Plug to Bare Drop Cable. The yellow CAN\_H wire goes to pin 2, the green CAN\_L wire goes to pin 3. Leave pin 1 and pin 4 empty.

**Step 2:** Squeeze the crimp areas of the Drop Plugs with the Split Joint Pliers.

**Step 3:** Locate the drop tap (not included) on the RV-C bus that is the closest to the installation site of the battery charger. The drop taps are usually located above the entry door, in the bathroom, or under the bed in the RV.

**Step 4:** Connect the Drop Plugs on the drop cables and other Renogy devices supporting CAN communication to the drop sockets on the drop tap.

**Step 5:** Insert the 7-Pin CAN Communication Terminal Plug into any of the CAN Communication Ports of the battery charger.

**i** If you fail to locate the drop taps, please contact the RV manufacturer for help.

**i** Different drop taps are used on the RV-C bus by different RV manufacturers. This user manual takes the 4-socket drop tap as an example.

### STEP-1 Install Cables on the RV-C bus

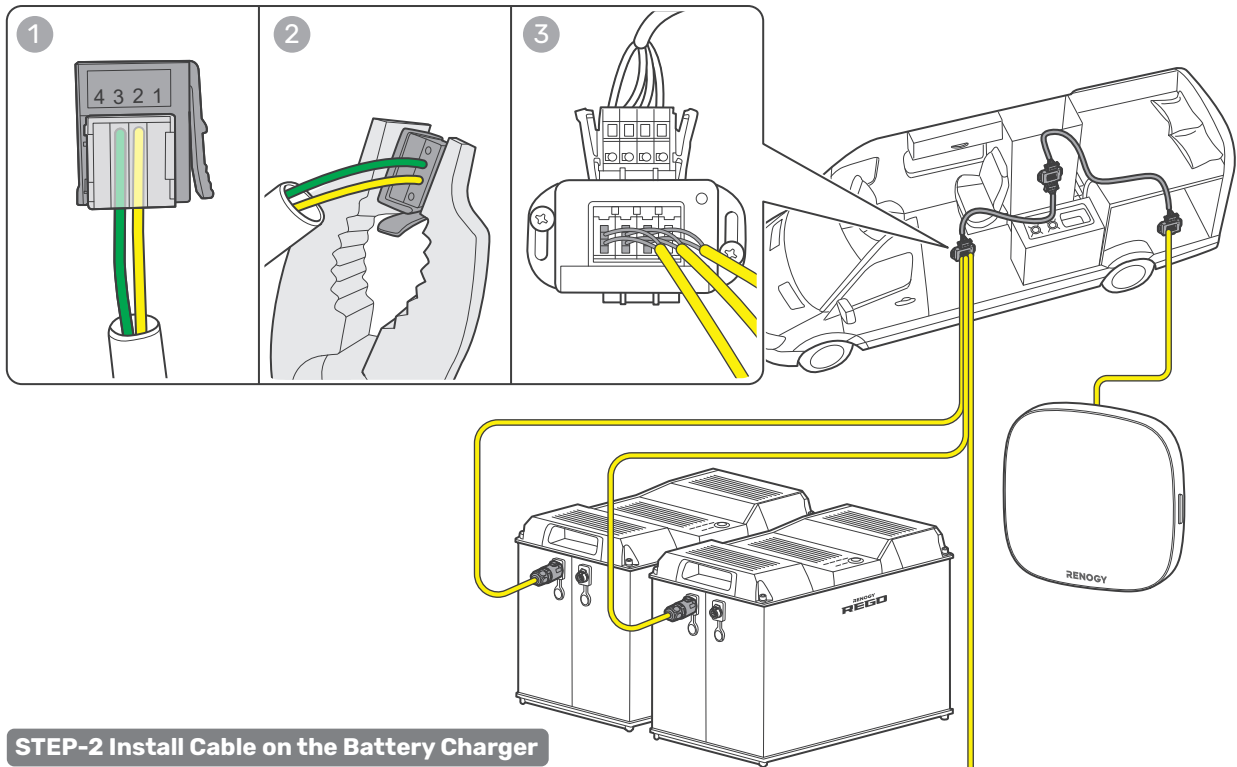

### STEP-2 Install Cable on the Battery Charger

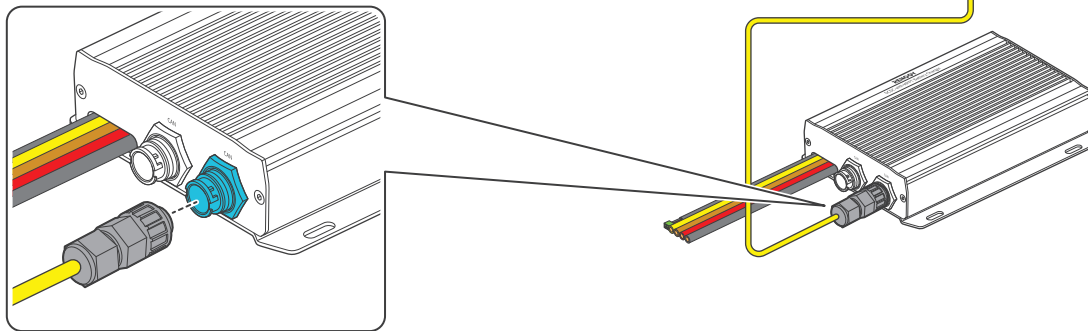

## Daisy Chain Network

The daisy chain network applies to RVs that are not integrated with RV-C buses.

Please select the appropriate adapter cable based on the type of the CAN Communication Port specific to the device. For example:

- Battery Charger to RENOZY ONE: 7-Pin CAN Communication Terminal Plug to RJ45 Communication Adapter Cable
- Battery Charger to REGO devices: 7-Pin CAN Communication Terminal Plug to LP16 Plug (7-Pin) Communication Adapter Cable
- Battery Charger to Renogy Combiner Box: 7-Pin CAN Communication Cable(s)



This section is based on an 7-Pin CAN Communication Terminal Plug to LP16 Plug (7-Pin) Communication Adapter Cable.

### Recommended Accessories

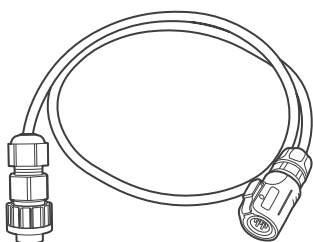

\*7-Pin CAN Communication Terminal Plug to LP16 Plug (7-Pin) Communication Adapter Cable(s)

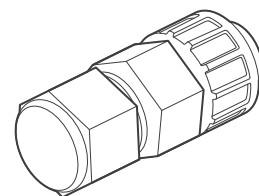

\*7-Pin CAN Communication Terminal Plug

- i** Accessories marked with "\*" are available on [renogy.com](http://renogy.com).
- i** The communication cable should be less than 19.6 feet (6 m).
- i** Choose proper terminal plugs based on the specific CAN ports.

The quantity of adapter cables and plugs varies based on the position of the battery charger in the daisy chain network. When the battery charger is positioned at either the first or the last device in the daisy chain network, one 7-Pin CAN Communication Terminal Plug and one adapter cable are required. In scenarios where the battery charger is located in the middle of the daisy chain network, two adapter cables are needed.

**Step 1:** Connect devices in series with the battery charger through either of the CAN Communication Ports with the Communication Cable(s) (sold separately).

**Step 2:** Plug the Terminator Plugs (sold separately) into the vacant CAN Communication Ports on the first and last devices.

### Battery Charger is Positioned at the First or Last in the Daisy Chain Network

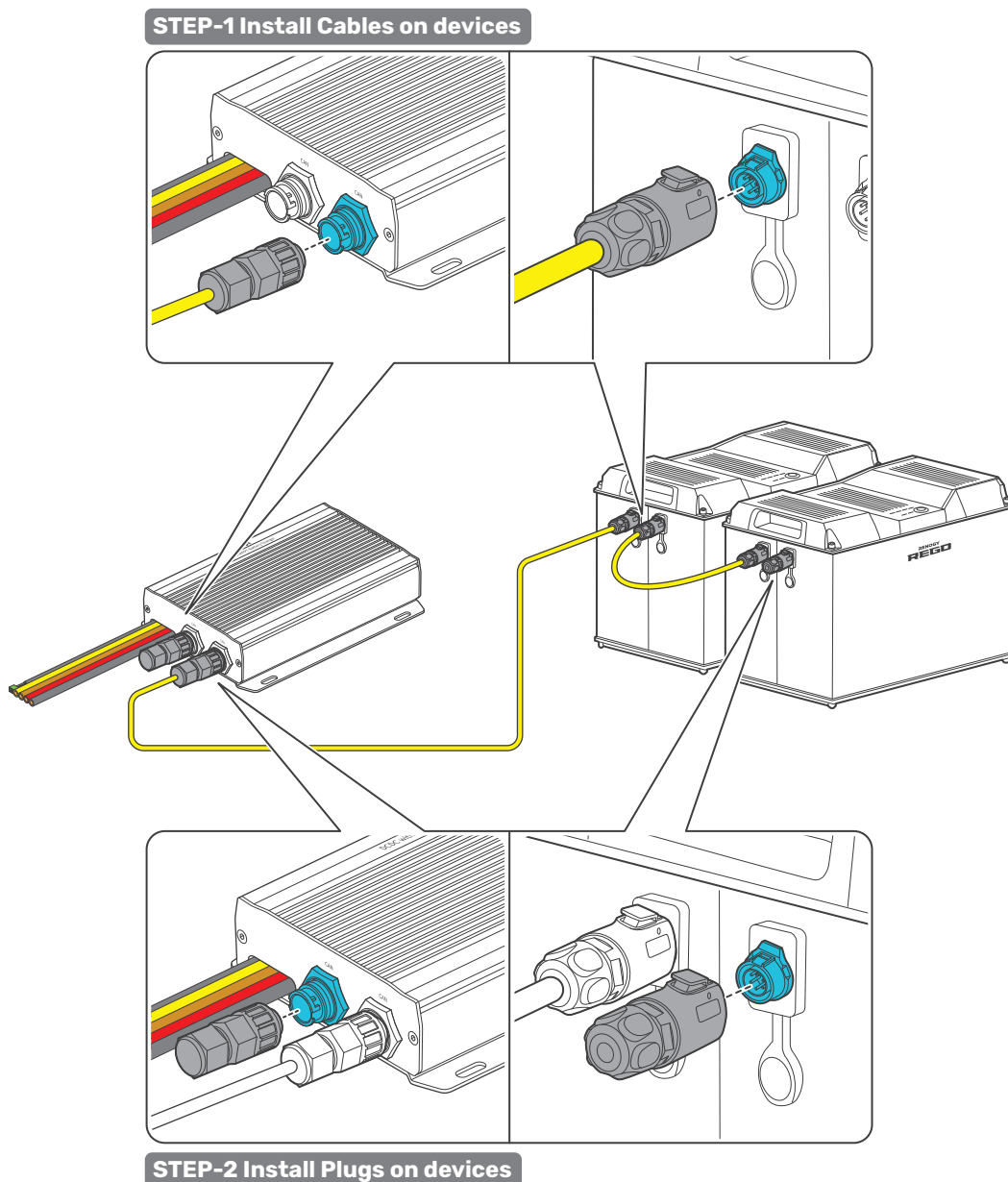

## Battery Charger is in the Middle of the Daisy Chain Network

### STEP-1 Install Cables on devices

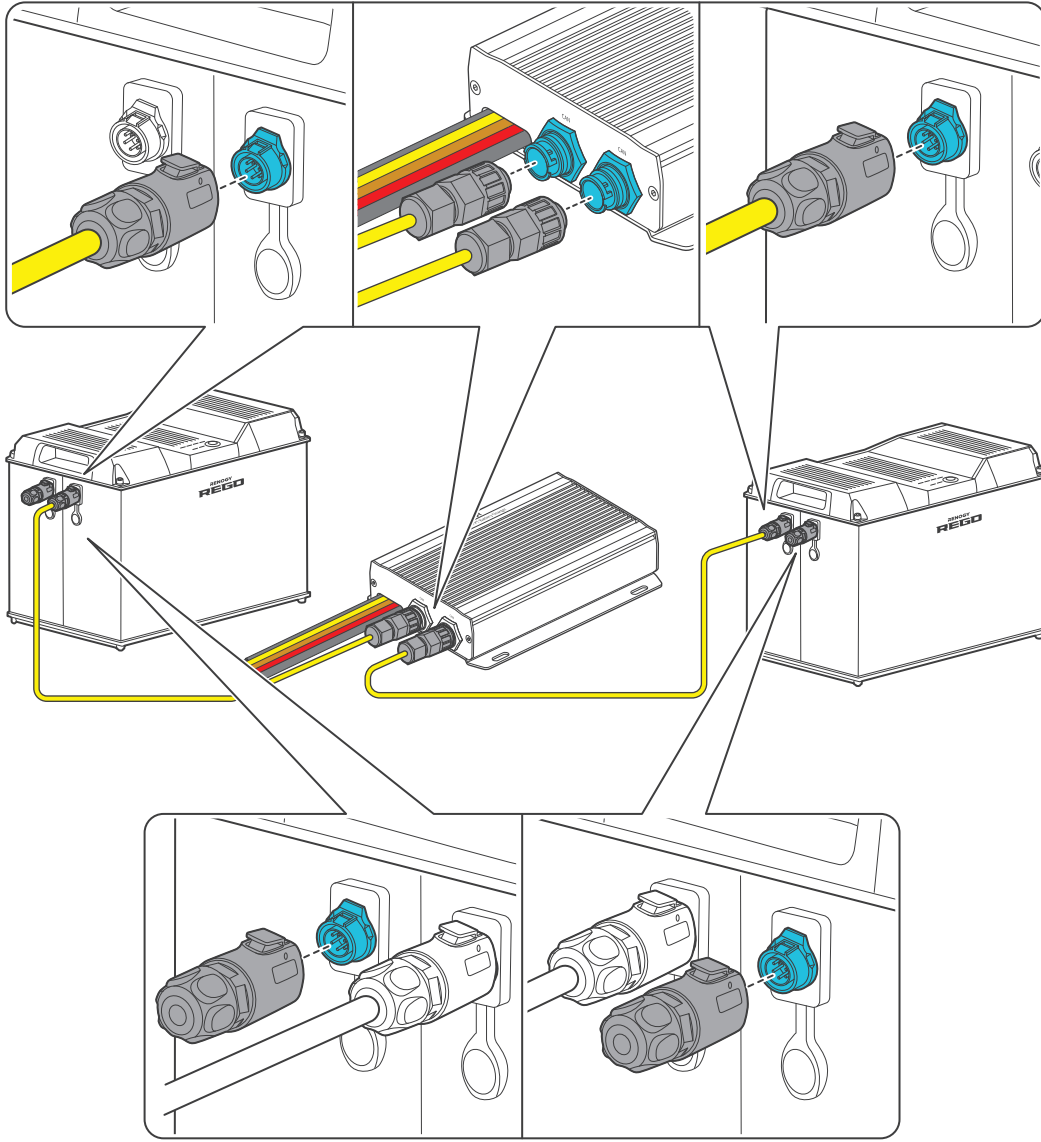

### STEP-2 Install Plugs on devices

## 4.8. Wire Inspection

Verify that all cable connections are firmly and securely fastened. This step is essential to prevent any loose or unstable connections that could lead to operational issues or safety concerns.

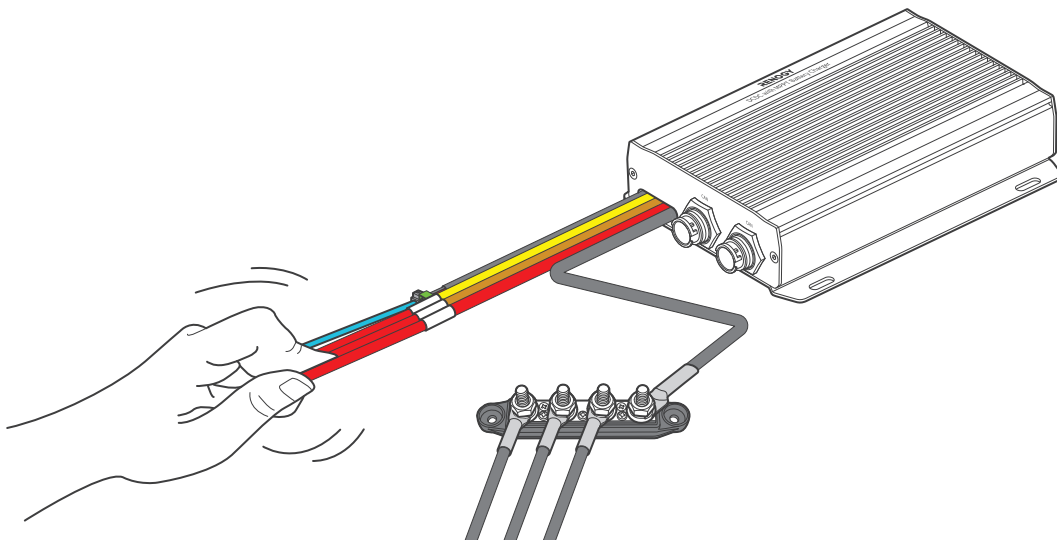



## 5. LED Indicators

The battery charger turns on automatically after power on with the LED indicators working in accordance with the relative operating status.

### Solar Charging Indicator

- **Off:** Not charging
- **Solid:** MPPT charging
- Slow flash:** Boost charging
- Single flash:** Float charging
- Double flash:** Limited-current charging
- Fast flash:** Equalization charging

### Alternator Charging Indicator

- **Off:** Not charging
- **Solid:** The starter battery connected to the alternator is charging the auxiliary battery.
- Slow flash:** The solar panel is charging the starter battery.

### Battery Type Indicator





- **Solid:** FLD
- **Solid:** GEL
- **Solid:** SLD/AGM
- **Solid:** 12V LI
- **Solid:** 24V LI
- **Solid:** User Mode

### Auxiliary Battery Indicator

- **Off:** No battery detected
- **Solid:** Full charge
- **Solid:** Normal battery voltage
- **Solid:** Undervoltage warning
- Slow flash:** Overdischarge warning
- Fast flash:** Overtemperature/Overvoltage warning

 If an error occurs, refer to “[9. Troubleshooting](#)” for details, or login to the DC Home app for troubleshooting details.

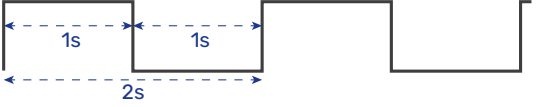
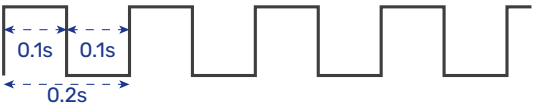
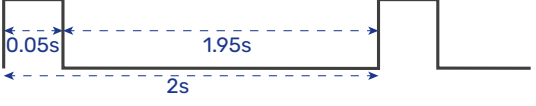
Check out the graphic indications of ON, OFF, Solid, Slow Flash, Fast Flash, Single Flash, and Double Flash of LEDs in the table below:

LED ON		LED OFF	
LED Pattern	Description	Graphic Expression	
Solid	The LED remains continuously illuminated without any variation.		
Slow Flash	In this mode, the LED alternates between being on and off at a relatively slow and regular interval of 1s.		
Fast Flash	In this mode, the LED alternates between being on and off at a relatively fast and regular interval of 0.1s.		
Single Flash	In this mode, the LED alternates between brief 0.05s on followed by a longer 1.95s off period.		
Double Flash	In this mode, the LED alternates between brief 0.1s on-off cycles followed by a longer 1.8s off period.		



## 6. Configuration

### 6.1. Set a Battery Type

Upon installing the battery charger, set a correct battery type by using the Battery Type Setting Button. A successful setting of the battery type is indicated by all LEDs illuminating from left to right (Solar to Type).

Press the Battery Type Setting Button to switch between different battery types. The LED indicates the battery type by displaying in different colors. For non-lithium batteries, the battery charger can automatically detect their voltage (12V or 24V).

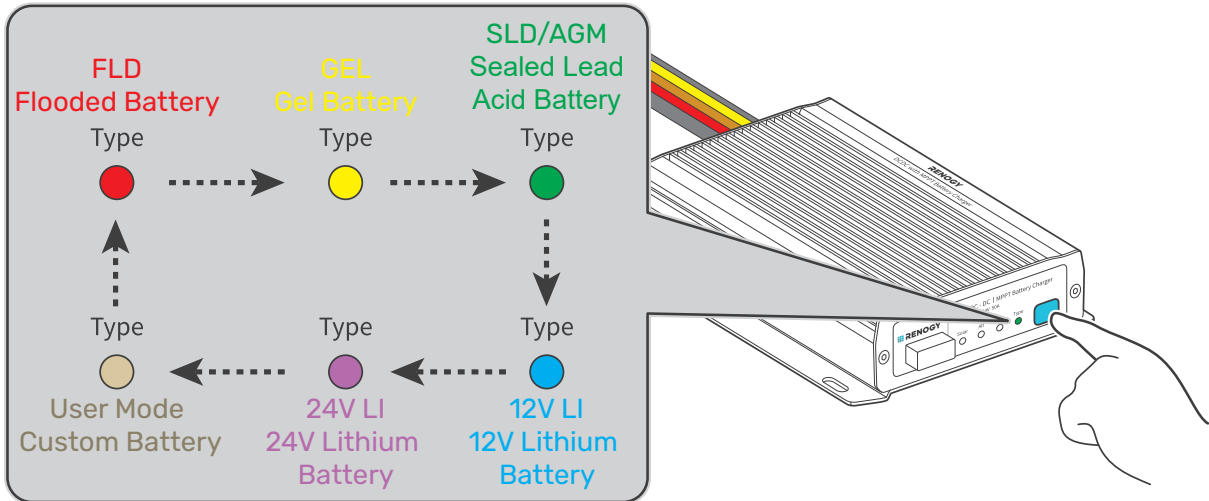

It is essential to ensure that the battery type setting is configured correctly to avoid any potential damage to the battery charger because any damage to the battery charger resulting from an incorrect battery type setting voids the warranty.

### 6.2. User Mode

Setting the battery type to User Mode allows you to customize your battery parameters. You can modify the parameters in the DC Home app.

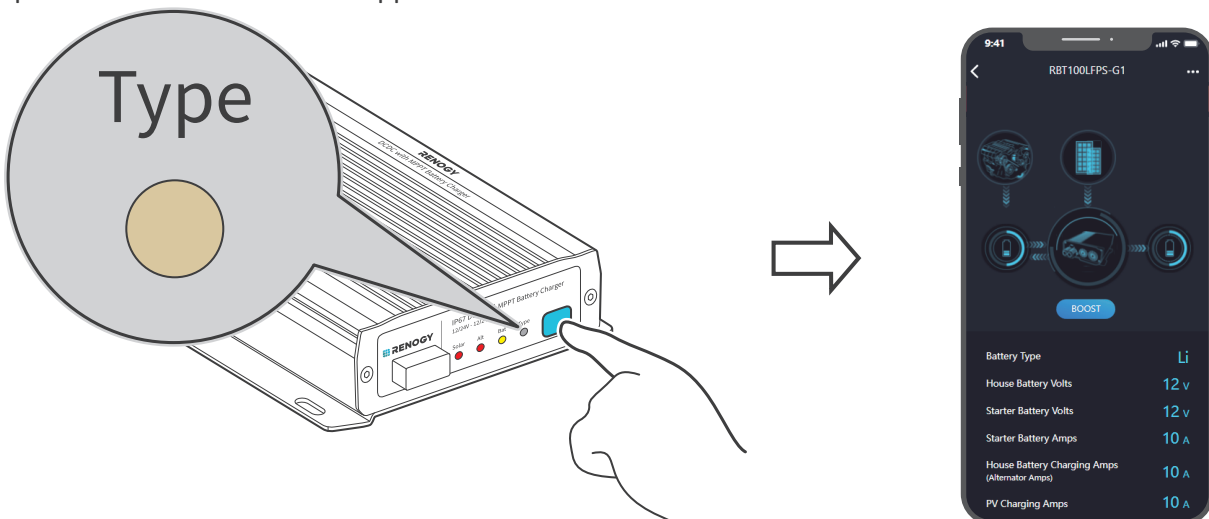

Before modifying battery parameters in User Mode, check the table below and consult the battery manufacturer to check whether modification is allowed. Incorrect parameter setting will damage the device and void the warranty.





In User Mode, when the Equalization Voltage matches the Boost Voltage and Float Voltage, the activation mechanism for the lithium battery is initiated.

<b>Maximum Combined Charging Current</b>	<ul style="list-style-type: none"> <li>● 12V Battery: 50A. Adjustable at 50A, 40A, 30A, 20A, and 10A.</li> <li>● 24V Battery: 25A. Adjustable at 25A, 20A, 15A, 10A, and 5A.</li> </ul>
<b>Equalization Voltage</b>	<ol style="list-style-type: none"> <li>1. For lead-acid batteries, please consult your battery manufacturer to obtain the voltage value and then complete the settings according to the feedback.</li> <li>2. If equalization charging is not required, set the voltage to boost voltage.</li> </ol>
<b>Boost Voltage</b>	This value affects whether the battery can be fully charged. Please consult the battery manufacturer and set the value properly.
<b>Float Voltage</b>	This value affects whether the battery can be fully charged. Please consult the battery manufacturer and set the value properly.
<b>Under Voltage Warning</b>	This voltage value affects the life of the battery. Consult the battery manufacturer and check if this voltage value needs to be set.
<b>Low Voltage Shutdown</b>	
<b>Boost Duration</b>	Please consult the battery manufacturer if it is necessary to set this parameter value.
<b>Equalization Duration</b>	
<b>Equalization Interval</b>	

### 6.3. Configure Charging Parameters

The table below illustrates the default and recommended parameters for batteries that can be connected to the battery charger. The parameters may vary depending on the specific battery you use. Read the user manual of the specific battery or contact the battery manufacturer for help if necessary.

 Before modifying battery parameters, check the table below first. Incorrect parameter setting will damage the device and void the warranty.

 Read the user manual of the battery when customizing a preset battery. Incorrect battery type selection damages the battery charger and voids the warranty.

The battery charger has a User Mode, and the specific default parameter values and customizable parameters should be primarily based on the actual displays in the DC Home app or Renogy ONE.

This table assumes default parameters for a 12V system. If the system voltage is 24V, double the values.

Parameters	Battery Type			
	SLD/AGM	GEL	FLOODED	LI (LFP)
<b>Overvoltage Shutdown</b>	16.0V	16.0V	16.0V	16.0V
<b>Equalization Voltage</b>	14.6V	—	14.8V	—
<b>Boost Voltage</b>	14.4V	14.2V	14.6V	14.4V
<b>Float Voltage</b>	13.8V	13.8V	13.8V	—
<b>Boost Return Voltage</b>	14.1V	13.9V	14.3V	14.1V
<b>Low Voltage Reconnect</b>	12.6V	12.6V	12.6V	12.6V
<b>Undervoltage Recover</b>	12.2V	12.2V	12.2V	12.2V
<b>Undervoltage Warning</b>	12.0V	12.0V	12.0V	12.0V
<b>Low Voltage Shutdown</b>	11.0V	11.0V	11.0V	11.0V
<b>Boost Duration</b>	120 min	120 min	120 min	—
<b>Equalization Duration</b>	120min	—	120 min	—

Parameters \ Battery Type	SLD/AGM	GEL	FLOODED	LI (LFP)
	Equalization Interval	30 days	–	30 days
Temperature Compensation	-3 mV / °C / 2V	-3 mV / °C / 2V	-3 mV / °C / 2V	–

## 6.4. Activate Lithium Batteries

The battery charger can activate connected lithium batteries. Lithium batteries may enter sleep mode when the in-built protection is triggered. In such case, the battery charger provides a small current to reactivate the sleeping lithium battery. The lithium battery can be charged normally after successful activation.



By default, the lithium activation function is enabled in the battery charger. You can disable it in the DC Home app.

### ■ Operation Condition

Set the battery type of the battery charger to LI or USER. For details, see [“6.1. Set a Battery Type”](#).

### ■ Operation Logic

- **For 12V Lithium Battery**





If the battery voltage drops below 9V, the battery charger automatically activates the activation function (on the premise that the activation function is enabled in the DC Home app) and continues to charge the battery using constant voltage until the battery voltage reaches 14.4V.

- **For 24V Lithium Battery**

If the battery voltage drops below 18V, the battery charger automatically activates the activation function (on the premise that the activation function is enabled in the DC Home app) and continues to charge the battery using constant voltage until the battery voltage reaches 28.8V.

## 7. Monitoring

Depending on the specific application, the battery charger can establish either short-range or long-range communication connections with monitoring devices. These monitoring devices facilitate real-time monitoring, programming, and complete system management, offering comprehensive control and enhanced flexibility.

-  Make sure the Bluetooth of your phone is turned on.
-  The version of the DC Home app might have been updated. Illustrations in the user manual are for reference only. Follow the instructions based on the current app version.
-  Make sure that the battery charger is properly installed and powered on before it is paired with the DC Home app.
-  To ensure optimal system performance, keep the phone within 10 feet (3 m) of the battery charger.

To ensure optimal connection performance, download the latest DC Home app. Login to the app with your account.

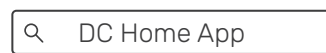
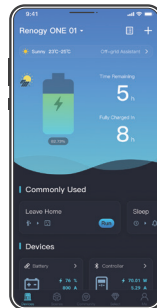

### 7.1. Short-Range Monitoring

If only short-range monitoring is required, connect the battery charger to the DC Home app directly through the Bluetooth of your phone.

**Step 1:** Open the DC Home app. Tap + to search for new devices.

**Step 2:** Tap **Confirm** to add the newly found device to the device list.

**Step 3:** Tap the battery charger icon to enter the device information interface.

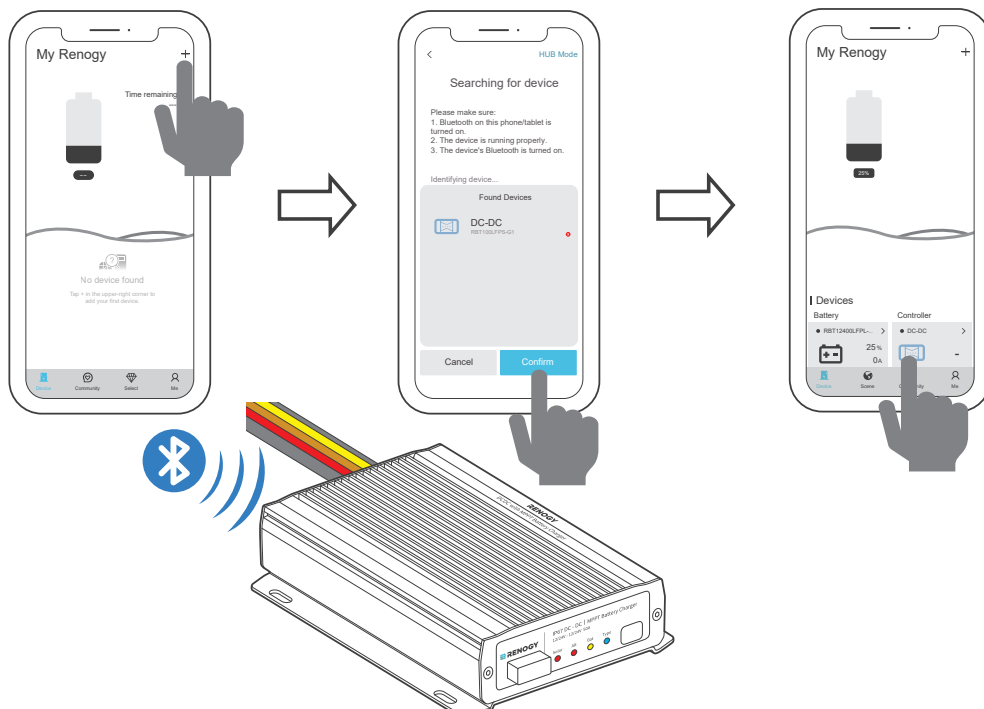

## 7.2. Wireless Long-Range Monitoring

If long-range communication and programming are required, connect the battery charger to Renogy ONE through Bluetooth, and then pair Renogy ONE with the DC Home app.

### Recommended Components

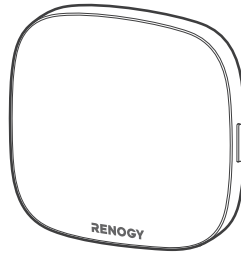

\*RENOGY ONE Core

- i** Components marked with "\*" are available on [renogy.com](https://www.renogy.com).
- i** Make sure that the Renogy ONE is powered on before the connection.
- i** For instructions on Renogy ONE, see [Renogy ONE Core User Manual](#).
- i** Make sure the battery charger does not communicate with any other device.

**Step 1:** Connect the battery charger to Renogy ONE through the Bluetooth of your phone.

**Step 2:** Pair the Renogy ONE with the DC Home app through Wi-Fi or by scanning the QR code in the Renogy ONE. On Renogy ONE, go to "**System > Settings > Pair with App**" to get the QR code.

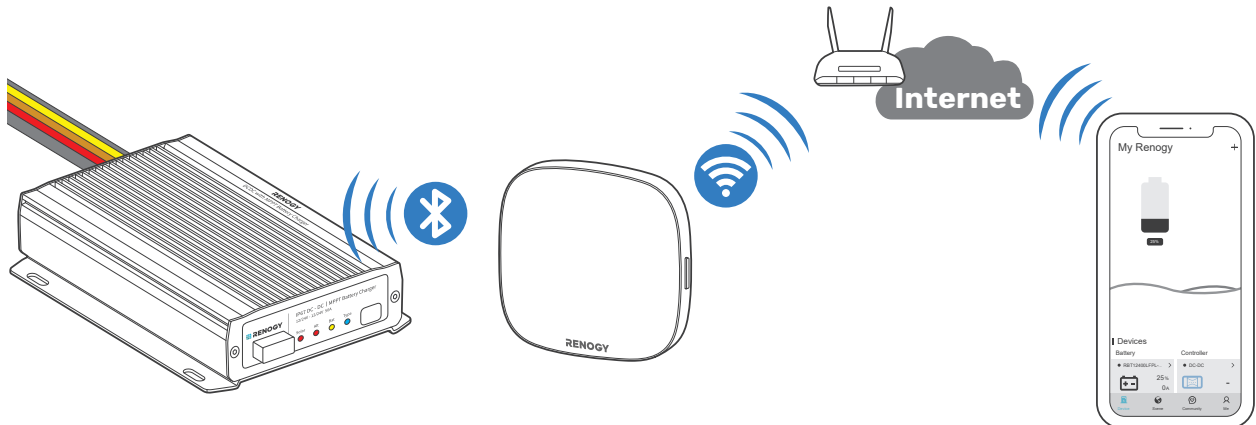

### 7.3. Wired Long-Range Monitoring (Backbone Network)

If long-range communication and programming are required, connect the battery charger to Renogy ONE through a RJ45 Plug to Bare Drop cable, and pair Renogy ONE with the DC Home app.

#### Recommended Components & Accessories



\*RENOGY ONE Core

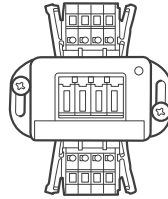

Common Drop Tap

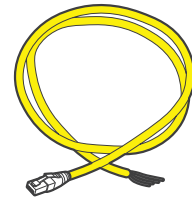

RJ45 Plug to Bare Drop Cable

- i** Components marked with "\*" are available on [renogy.com](https://www.renogy.com).
- i** Make sure that the Renogy ONE is powered on before the connection.
- i** For instructions on Renogy ONE, see [Renogy ONE Core User Manual](#).
- i** Make sure the battery charger does not communicate with any other device.
- i** Select the appropriate communication cable (sold separately) according to the distance between devices. The communication cable should be less than 19.6 feet (6 m).
- i** Different terminal block plugs are used on different Common Drop Taps and follow different pinouts. If you are unsure about the pinout of the terminal block plug, contact the RV manufacturer.

**Step 1:** Replace the terminated drop tap at either end of the RV-C bus with the Common Drop Tap (not included). Secure the bare wires of the Drop Cable (not included) onto the terminal block plug of the Common Drop Tap following the terminal block plug pinout. Plug the Drop Cable to the RJ45 port of Renogy ONE.

**Step 2:** Monitor and program the complete system on Renogy ONE or the DC Home app.

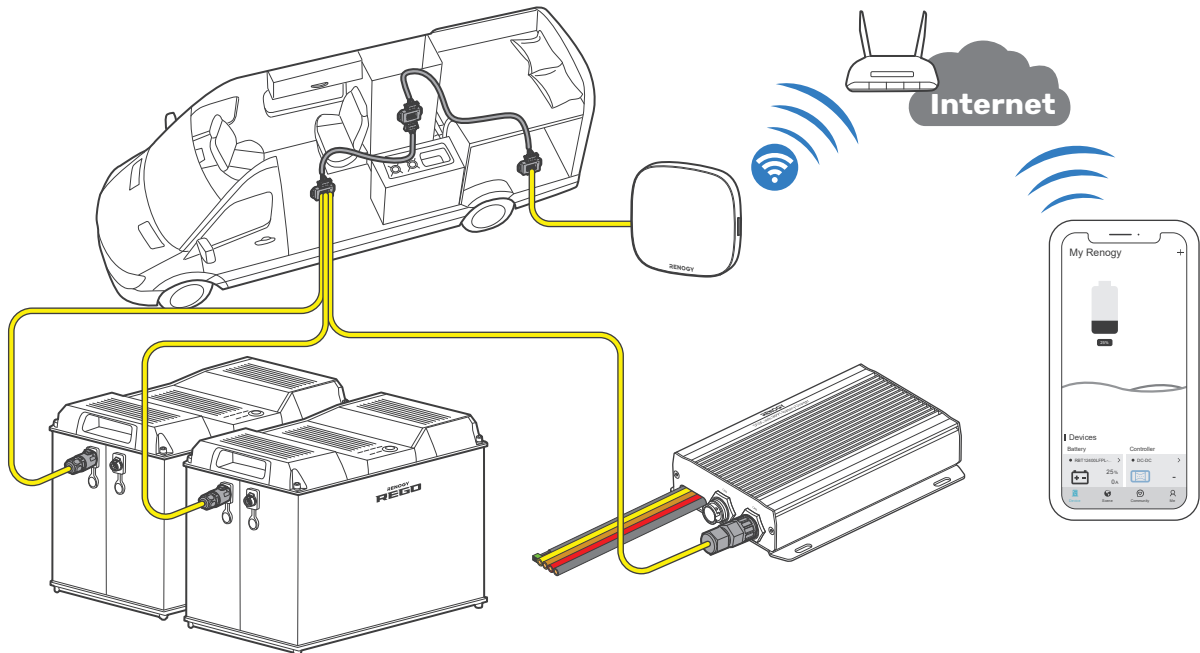

## 7.4. Wired Long-Range Monitoring (Daisy Chain Network)

If long-range communication and programming are required, connect the battery charger to Renogy ONE through wires, and pair Renogy ONE with the DC Home app.

### Recommended Components & Accessories



\*RENOGY ONE Core

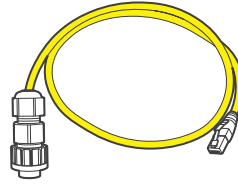

\*7-Pin CAN Communication Terminal Plug to RJ45 Communication Adapter Cable

- i** Components marked with "\*" are available on [renogy.com](https://www.renogy.com).
- i** Make sure that the Renogy ONE is powered on before the connection.
- i** The 7-Pin CAN Communication Terminal Plug to RJ45 Communication Adapter Cable is exclusively designed for scenarios where the Battery Charger is positioned at the first or last in the daisy chain network. If the Battery Charger is in the middle of the daisy chain network, please select the appropriate adapter cable based on the CAN communication port type of the first or last device.
- i** For instructions on Renogy ONE, see [Renogy ONE Core User Manual](#).
- i** Make sure the battery charger does not communicate with any other device.
- i** Select the appropriate communication cable (sold separately) according to the distance between devices. The communication cable should be less than 19.6 feet (6 m).

**Step 1:** Remove the Terminator Plug from the Renogy devices supporting CAN communication at either end of the daisy chain.

**Step 2:** Connect the Renogy ONE to the free CAN Communication Port on the Renogy devices supporting CAN communication with the Communication Adapter Cable (sold separately).

**Step 3:** Pair Renogy ONE with the DC Home app. Monitor and program the complete system on the Renogy ONE or the DC Home app.

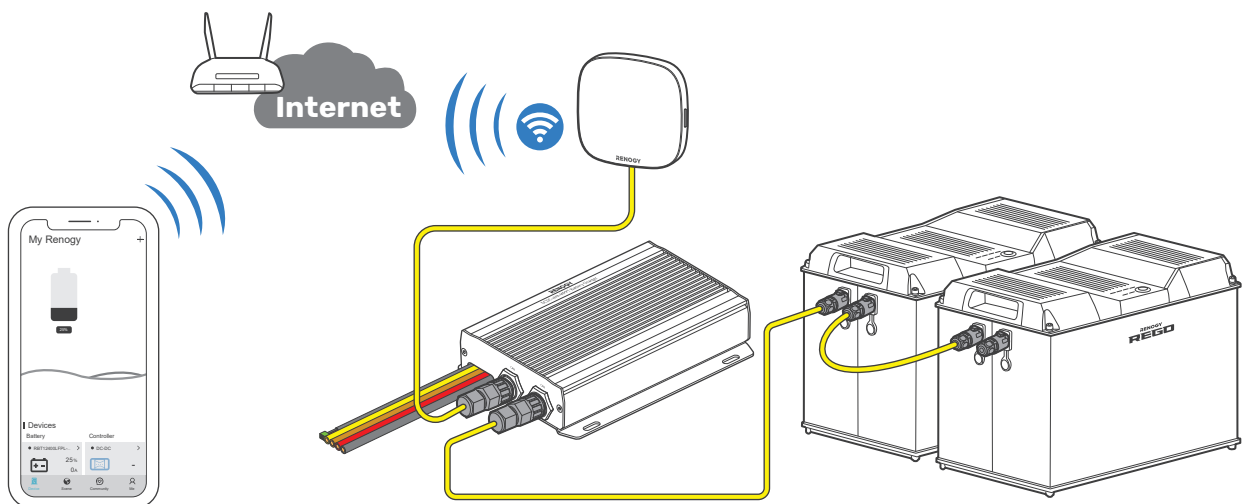

## 8. Working & Charging Logic

### 8.1. Automatic Voltage Matching Function

Whether you are connecting a 12V or 24V solar panel or starter battery, this battery charger will automatically adjust the charging current and voltage values based on the rated voltage of the battery being charged.

#### ■ Charging the Auxiliary Battery

Nominal Voltage			Battery Charger Status	Charging Voltage	Maximum Charging Current
Auxiliary Battery	Solar Panel	Starter Battery			
12V	12V	12V	-	12V	50A
	12V	24V	Steps down		
	24V	12V	Steps down		
	24V	24V	Steps down		
24V	12V	12V	Boost	24V	25A
	12V	24V	Boost		
	24V	12V	Boost		
	24V	24V	-		



For details about when the solar panel and/or starter battery charge(s) the auxiliary battery, see ["8.2. Charging Logic"](#) in this manual.

#### ■ Charging the Starter Battery

Nominal Voltage			Battery Charger Status	Charging Voltage	Maximum Charging Current
Starter Battery	Solar Panel	Auxiliary Battery			
12V	12V	12V	-	12V	25A
	12V	24V	Steps down		
	24V	12V	Steps down		
	24V	24V	Steps down		
24V	12V	12V	Boost	24V	12.5A
	12V	24V	Boost		
	24V	12V	Boost		
	24V	24V	-		



For details about when the solar panel and/or starter battery charge(s) the auxiliary battery, see ["8.2. Charging Logic"](#) in this manual.





## 8.2. Charging Logic

The battery charger allows you to charge the auxiliary battery with a starter battery connected to an alternator, with solar panels connected directly to the battery charger, or with both solar panel and starter battery. The charging logic depends on the connection method.

The battery charger employs the “Solar Power Green Priority” logic for charging. The battery charger determines the charging source by assessing the adequacy of solar power using the following formula.

$$\text{Solar-generated Power} = \text{LowSolar Current Shutdown} \times \text{Output Voltage of the Battery Charger}$$

You need to customize the “LowSolar Current Shutdown” through the DC Home app.

-  Please refer to the actual displays in the DC Home app for the default value and setting range of LowSolar Current Shutdown.
-  The maximum charging power from the battery charger is not affected by the system voltage and remains at 720W.

### ■ When Solar-Generated Power is Adequate



The battery charger charges the auxiliary battery using solar power only when the solar-generated power is adequate. For details, see the table below:

Working Conditions	Stop Conditions
<p>Solar input voltage &gt; 15V</p> <p>After a delay of 10 seconds, the battery charger will exclusively utilize the current provided by the solar panel for charging.</p>	<p>Solar input voltage &lt; 15V</p> <p>The battery charger stops exclusively using the solar panel for charging.</p>

### ■ When Solar-Generated Power is Slightly Inadequate

The battery charger adopts both solar power and the starter battery to charge the auxiliary battery when the solar-generated power is slightly inadequate.

Starter Battery Nominal Voltage	Working Conditions	Stop Conditions
12V	<p>Solar input voltage &lt; 15V <b>and</b> Starter battery voltage &gt; 13.2V</p>	<p>Solar input voltage &gt; 15V <b>or</b> Starter battery voltage &lt; 12.7V</p>
24V	<p>Solar input voltage &lt; 15V <b>and</b> Starter battery voltage &gt; 26.4V</p>	<p>Solar input voltage &gt; 15V <b>or</b> Starter battery voltage &lt; 25.4V</p>

-  The parameters in the above table are default values, and you can customize them through the DC Home app. Please refer to the actual displays in the DC Home app for the specific customization range.
-  Please consult the vehicle manufacturer before modifying the voltage values for the working and stop conditions of the starter battery. Failure to do so may result in the starter battery being depleted due to excessive discharge.

## ■ When Solar-Generated Power is Severely Inadequate

When solar power is severely inadequate, the battery charger charges the auxiliary battery by utilizing only the starter battery.

Starter Battery Nominal Voltage	Working Conditions	Stop Conditions
12V	<p>Solar output current &lt; LowSolar Current Shutdown <b>and</b> Starter battery voltage &gt; 13.2V</p> <p>After 15 seconds, the battery charger will utilize the current provided by the starter battery for charging.</p>	<p>Solar output current &gt; LowSolar Current Shutdown <b>or</b> Starter battery voltage &lt; 12.7V</p>
24V	<p>Solar output current &lt; LowSolar Current Shutdown <b>and</b> Starter battery voltage &gt; 26.4V</p> <p>After 15 seconds, the battery charger will utilize the current provided by the starter battery for charging.</p>	<p>Solar output current &gt; LowSolar Current Shutdown <b>or</b> Starter battery voltage &lt; 25.4V</p>

**i** The parameters “LowSolar Current Shutdown” and “Starter Battery Voltage” in the above table are default values, and you can customize them through the DC Home app. Please refer to the actual displays in the DC Home app for the specific customization range.

**i** Please consult the vehicle manufacturer before modifying the voltage values for the working and stop conditions of the starter battery. Failure to do so may result in the starter battery being depleted due to excessive discharge.

## ■ Trickle Charging Starter Battery

Once the auxiliary battery is fully charged, the battery charger will utilize the solar panel to provide a trickle charge to the starter battery.

Starter Battery Nominal Voltage	Working Conditions	Stop Conditions	Maximum Charging Voltage for the Starter Battery
12V	<ul style="list-style-type: none"> <li>● Auxiliary battery fully charged</li> <li>● 6V &lt; Starter Battery Voltage &lt; 13.2V</li> </ul>	<p>The solar panel continuously charges the starter battery for 1 minute, followed by a 30-second pause. During this time, the voltage of the starter battery is monitored. If the starter battery voltage is greater than 13.2V, charging will be stopped. Otherwise, the charging cycle will continue.</p>	13.8V
24V	<ul style="list-style-type: none"> <li>● Auxiliary battery fully charged</li> <li>● 12V &lt; Starter Battery Voltage &lt; 26.4V</li> </ul>	<p>The solar panel continuously charges the starter battery for 1 minute, followed by a 30-second pause. During this time, the voltage of the starter battery is monitored. If the starter battery voltage is greater than 26.4V, charging will be stopped. Otherwise, the charging cycle will continue.</p>	27.6V

### 8.3. Battery Charging Stages

The battery charger utilizes cutting-edge MPPT technology to efficiently track the maximum power output of solar panels in various conditions, ensuring real-time optimization. It also incorporates four distinct charging stages: bulk, boost, float, and equalization.

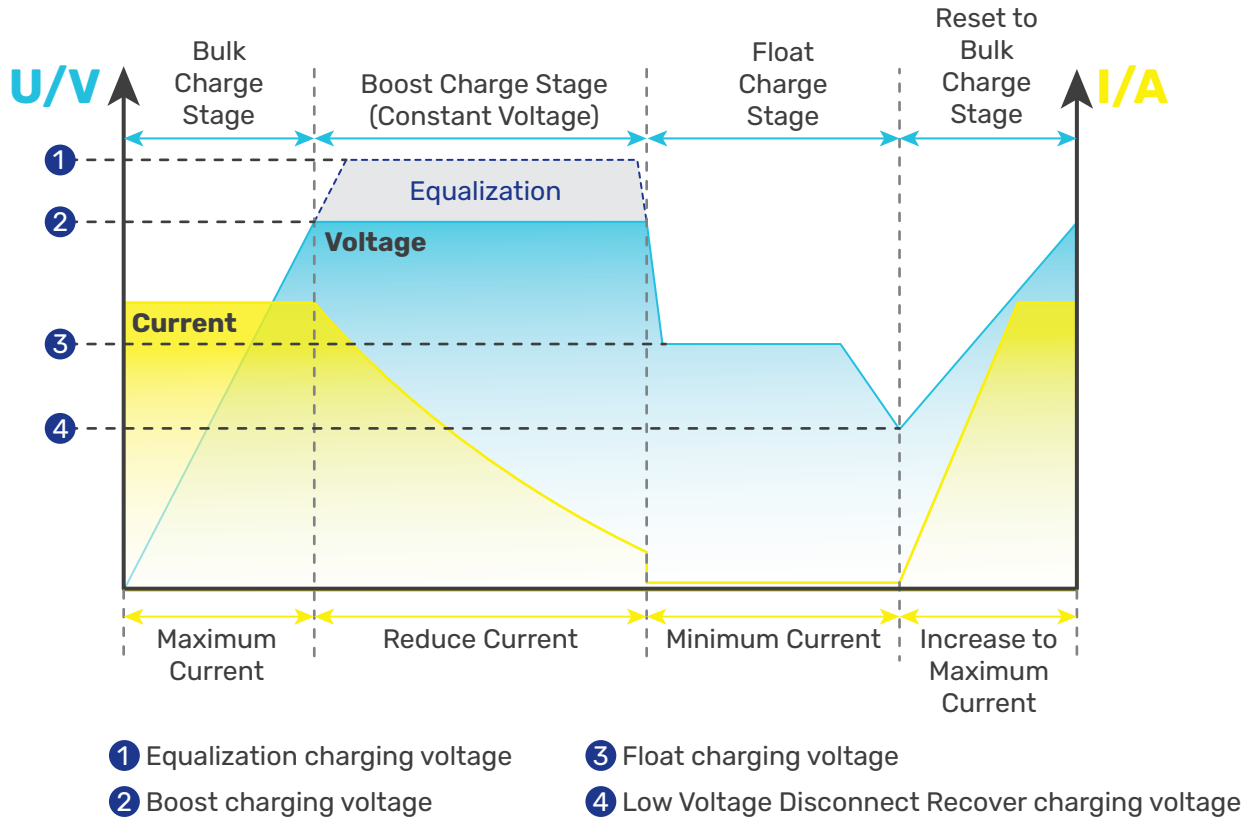

**i** Adjust the time depending on the specific battery bank size.

#### Bulk Charge Stage

The battery charger will supply constant current until the battery voltage reaches the boost voltage.

#### Boost Charge Stage

The battery charger will supply constant voltage and reduce the current slowly through this stage.

Default boost duration: 2 hours. After this time, the charger will enter the float stage.

**i** Boost Duration is not applicable to lithium batteries.

**i** The stage is determined by internal software in the battery charger.

#### Float Charge Stage



During this stage the battery charger will supply a constant voltage which is determined by the battery selected and will keep current at a minimum level. This stage acts as a trickle charger.

After reaching a constant voltage in the charging process, the battery charger reduces the voltage to a float level. At this point, the battery is fully charged, and any excess current is converted to heat or gas. The charger then maintains a lower voltage to offset power consumption, ensuring a full battery capacity. If a load exceeds the charge current, the charger exits float mode and returns to bulk charging.

**i** Float charging is not applicable to lithium batteries.





#### Equalization

This stage is only available for batteries with equalization, such as non-sealed, vented, flooded, and wet cell lead acid batteries. During this stage the batteries are charged at a higher voltage than normal and for most batteries this could cause damage. Refer to the user manual of the battery or contact the battery manufacturer to see if this stage is needed.

-  During Equalization charging, the battery charger remains in this stage until sufficient charging current is sourced from the solar panel. Note that there should be no load on the batteries during Equalization charging..
-  Overcharging and excessive gas precipitation can harm battery plates, leading to material shedding. Carefully review the battery's specific requirements to avoid damage from prolonged or excessively high Equalization charging .
-  Equalization may elevate battery voltage to levels that could damage sensitive DC loads. Ensure that the allowable input voltages of all loads exceed the set voltage during Equalization charging..

## 9. Troubleshooting

This section discusses general troubleshooting tips specific to LED indicator status.

LED	Fault	Possible Cause	Solution
Solar 	Indicates the solar charging fails to function well.	<ul style="list-style-type: none"> <li>The output voltage of the solar panel is below 15V.</li> <li>The output voltage of the solar panel is excessively high, triggering overvoltage protection.</li> </ul>	<ul style="list-style-type: none"> <li>For solar panel voltage under 15V, ensure there is no shade or damage on the solar panel.</li> <li>In scenarios where overvoltage protection is triggered, check the way in which the solar panels are connected.</li> </ul>
Alt 	Indicates the starter battery is not charging the auxiliary battery.	The starter battery voltage is below 13.2V.	Recheck the alternator type. For details, see <a href="#">“3.7. Check the Alternator on Your Automobile”</a> in this manual. If the actual output value from the alternator is relatively low, modify the cut-in voltage in the DC Home app.
Bat  Solid	An undervoltage warning is triggered in the auxiliary battery.	The auxiliary battery voltage is low.	Charge the auxiliary battery immediately.
Bat  Slow flash	An overdischarge warning is triggered in the auxiliary battery.	The auxiliary battery is over-discharged.	Disconnect all loads from the auxiliary battery, and charge it immediately.
Bat  Fast flash	An overvoltage or overtemperature warning is triggered in the auxiliary battery.	The auxiliary battery is over-charged or at a high temperature.	<ul style="list-style-type: none"> <li>If the protection is triggered without a Battery Temperature Sensor installed, it indicates the auxiliary battery is overcharged.</li> <li>If the protection is triggered with a Battery Temperature Sensor installed, the auxiliary battery is at a high temperature. Follow the troubleshooting steps below:               <ol style="list-style-type: none"> <li>Check the auxiliary battery temperature in the DC Home app. Temperatures higher than 149°F (65°C) result in an overtemperature alarm. Ensure the auxiliary battery is installed in a well-ventilated site. The warning for the auxiliary battery temperature is cleared when it drops to 140°F (60°C).</li> <li>Check the auxiliary battery voltage. For 12V batteries, the auxiliary battery voltage should be within 16V. For 24V batteries, the auxiliary battery voltage should be within 32V. Higher voltages trigger an overvoltage alarm. In such case, stop charging the auxiliary battery.</li> </ol> </li> </ul>

-	The battery charger stops charging.	Low-temperature protection for the auxiliary battery.	When the temperature of the auxiliary battery drops below -31°F (-35°C), the battery charger will stop charging. Please warm up the auxiliary battery, and charging will resume once the temperature is above -22°F (-30°C).
		Over-temperature protection for the battery charger.	If the temperature of the battery charger exceeds 176°F (80°C), immediately provide ventilation to cool down the charger. The normal operating temperature range for the battery charger is -31°F to 176°F (-35°C to 80°C). When the temperature exceeds 149°F (65°C), the charger will decrease its load. If the temperature exceeds 176°F (80°C), the battery charger will stop working.



For technical support, contact our technical service through [renogy.com/contact-us](https://renogy.com/contact-us).

## 10. Dimensions & Specifications

### 10.1. Dimensions

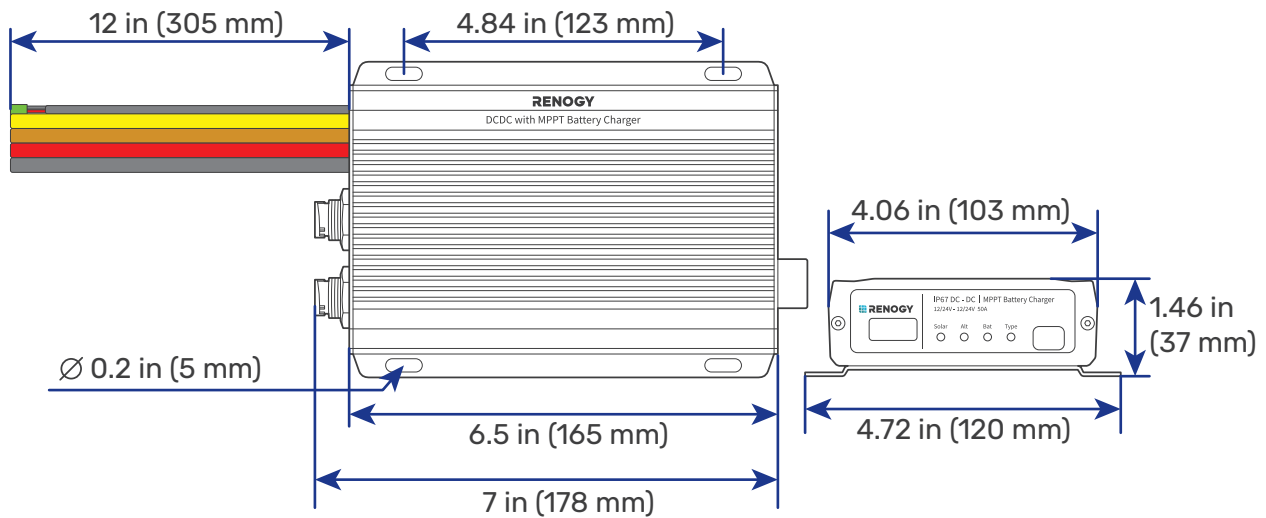

**i** Dimension tolerance:  $\pm 0.2$  in (0.5 mm)

### 10.2. Technical Specifications

<b>System Voltage</b>	12V/24V to 12V/24V DC
<b>Nominal Output Power</b>	720W
<b>Battery Voltage Range</b>	9V to 32V DC
<b>Maximum Charging Current</b>	50A@12V 25A@24V
<b>Battery Type</b>	SLD, AGM, GEL, FLD, LI, and USER
<b>Auxiliary Battery Charging Mode</b>	MPPT
<b>Nominal Charging Efficiency</b>	For 12V batteries: $\geq 94\%$ For 24V batteries: $\geq 92\%$
<b>Max. Solar Input Voltage</b>	50V
<b>Max. Alternator Input Voltage</b>	32V
<b>Operating Temperature Range</b>	-31°F to 176°F / -35°C to 80°C
<b>Storage Temperature</b>	-40°F to 176°F / -40°C to 80°C
<b>No Load Current</b>	< 100mA
<b>Humidity</b>	0% to 95%, RH, no condensation
<b>Dimensions</b>	7.01 x 4.78 x 1.47 in / 178.2 x 121.5 x 37.5 mm
<b>Weight</b>	4.10 lb / 1.86 kg
<b>Certifications</b>	CE, RoHS, and FCC Part 15 Class B

## 11. Maintenance

### 11.1. Inspection

For optimum performance, it is recommended to perform these tasks regularly.

- Ensure the battery charger is installed in a clean, dry, and ventilated area.
- Ensure there is no damage or wear on the cables.
- Ensure the firmness of the connectors and check if there are any loose, damaged or burnt connections.
- Make sure the indicators are in proper condition.
- Ensure there is no corrosion, insulation damage, or discoloration marks of overheating or burning.
- If the battery charger is dirty, use a damp cloth to clean the outside of the device to prevent dust and dirt from accumulating. Before the battery charger is powered on, make sure it is completely dry after cleaning.
- Make sure the ventilation holes are not blocked.

 In some applications, corrosion may exist around the terminals. Corrosion can loosen springs and increase resistance, leading to premature connection failure. Apply dielectric grease to each terminal contact periodically. Dielectric grease repels moisture and protects the terminal contacts from corrosion.

 Risk of electric shock! Make sure that all power supplies are turned off before touching terminals on the battery charger.

### 11.2. Cleaning

Follow the steps below to clean the battery charger regularly.

- Disconnect all cables connected to the battery charger.
- Wear proper protective equipment and use insulated tools during operation. Be careful when touching bare terminals of capacitors as they may retain high lethal voltages even after power is removed.
- Wipe the housing of the battery charger and connector contacts with a dry cloth or nonmetallic brush. If it is still dirty, you can use household cleaners.
- Make sure the ventilation holes are not blocked.
- Dry the battery charger with a clean cloth and keep the area around the battery charger clean and dry.
- Make sure the battery charger is completely dry before reconnecting it to the solar panel, battery and AC input.

### 11.3. Storage

Follow the tips below to ensure that the battery charger is stored well.

- Disconnect all cables connected to the battery charger.
- By applying dielectric grease to each terminal, the dielectric grease repels moisture and protects the connector contacts from corrosion.
- Store the battery charger in a well-ventilated, dry, and clean environment with the temperature between -40°F to 176°F or -40°C to 80°C.



## 12. Emergency Responses

In the event of any threat to health or safety, always begin with the steps below before addressing other suggestions.

- Immediately contact the fire department or other relevant emergency response team.
- Notify all people who might be affected and ensure that they can evacuate the area.

 Only perform the suggested actions below if it is safe to do so.

### 12.1. Fire

1. Disconnect all cables connected to the battery charger.
2. Put out the fire with a fire extinguisher. Acceptable fire extinguishers include water, CO<sub>2</sub>, and ABC.

 Do not use type D (flammable metal) fire extinguishers.

### 12.2. Flooding

1. If the battery charger is submerged in water, stay away from the water.
2. Disconnect all cables connected to the battery charger.

### 12.3. Smell

1. Ventilate the room. Disconnect all cables connected to the battery charger.
2. Ensure that nothing is in contact with the battery charger.

### 12.4. Noise

1. Disconnect all cables connected to the battery charger.
2. Make sure no foreign objects are stuck in the fan of the battery charger or the ring terminal.

 The normal noise value of the battery charger is less than 30dB during operation. If the noise is abnormal, contact our technical service through [renogy.com/contact-us](https://renogy.com/contact-us).

# Renogy Support

To discuss inaccuracies or omissions in this quick guide or user manual, visit or contact us at:

 | [renogy.com/support/downloads](https://renogy.com/support/downloads)

 → [contentservice@renogy.com](mailto:contentservice@renogy.com)

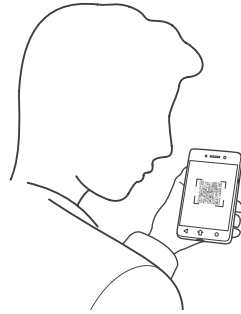

Questionnaire Investigation



To explore more possibilities of solar systems, visit Renogy Learning Center at:

 | [renogy.com/learning-center](https://renogy.com/learning-center)

For technical questions about your product in the U.S., contact the Renogy technical support team through:

 | [renogy.com/contact-us](https://renogy.com/contact-us)

 1(909)2877111

For technical support outside the U.S., visit the local website below:

**Canada** |  | [ca.renogy.com](https://ca.renogy.com)

**China** |  | [www.renogy.cn](https://www.renogy.cn)

**Australia** |  | [au.renogy.com](https://au.renogy.com)

**Japan** |  | [renogy.jp](https://renogy.jp)

**South Korea** |  | [kr.renogy.com](https://kr.renogy.com)

**Germany** |  | [de.renogy.com](https://de.renogy.com)

**United Kingdom** |  | [uk.renogy.com](https://uk.renogy.com)

**Other Europe** |  | [eu.renogy.com](https://eu.renogy.com)

## FCC Statement

This device complies with Part 15 of the FCC Rules. Operation is subject to the following two conditions:

- (1) This device may not cause harmful interference.
- (2) This device must accept any interference received, including interference that may cause undesired operation.

Any Changes or modifications not expressly approved by the party responsible for compliance could void the user's authority to operate the equipment.

This equipment has been tested and found to comply with the limits for a Class B digital device, pursuant to Part 15 of the FCC Rules. These limits are designed to provide reasonable protection against harmful interference in a residential installation. This equipment generates, uses and can radiate radio frequency energy and, if not installed and used in accordance with the instructions, may cause harmful interference to radio communications. However, there is no guarantee that interference will not occur in a particular installation. If this equipment does cause harmful interference to radio or television reception, which can be determined by turning the equipment off and on, the user is encouraged to try to correct the interference by one or more of the following measures:

- (1) Reorient or relocate the receiving antenna.
- (2) Increase the separation between the equipment and receiver.
- (3) Connect the equipment into an outlet on a circuit different from that to which the receiver is connected.
- (4) Consult the dealer or an experienced radio / TV technician for help.

## FCC Radiation Exposure Statement

This equipment complies with FCC radiation exposure limits set forth for an uncontrolled environment. This equipment should be installed and operated with minimum distance 20 cm between the radiator & your body.



## Renogy Empowered

Renogy aims to empower people around the world through education and distribution of DIY-friendly renewable energy solutions.

We intend to be a driving force for sustainable living and energy independence.

In support of this effort, our range of solar products makes it possible for you to minimize your carbon footprint by reducing the need for grid power.



## Live Sustainably with Renogy

Did you know? In a given month, a 1kW solar energy system will...



Save 170 pounds of coal from being burned



Save 300 pounds of CO<sub>2</sub> from being released into the atmosphere



Save 105 gallons of water from being consumed



## Renogy Power PLUS

Renogy Power Plus allows you to stay in the loop with upcoming solar energy innovations, share your experiences with your solar energy journey, and connect with like-minded people who are changing the world in the Renogy Power Plus community.



@Renogy Solar



@renogyofficial



@Renogy

Renogy reserves the right to change the contents of this manual without notice.

Manufacturer: RENOGY New Energy Co.,Ltd  
Address: No.66, East Ningbo Road Room 624-625  
Taicang German Overseas Students Pioneer Park  
JiangSu 215000 CN



EVATOST CONSULTING LTD  
Suite 11, First Floor, Moy Road Business  
Centre, Taffs Well, Cardiff, Wales, CF15 7QR  
contact@evatmaster.com

Manufacturer: RENOGY New Energy Co.,Ltd  
Address: No.66, East Ningbo Road Room 624-625  
Taicang German Overseas Students Pioneer Park  
JiangSu 215000 CN



eVatmaster Consulting GmbH  
Battinatr. 30  
60325 Frankfurt am Main, Germany  
contact@evatmaster.com



Intertek  
5021988

FCC ID : 2ANPB-RIV4835PCS