

MONITORING SCREEN

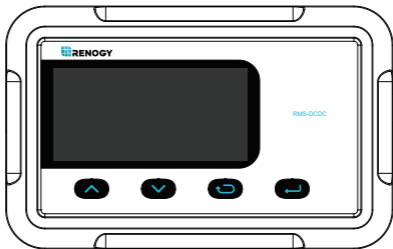

FOR DC-DC BATTERY CHARGER SERIES

Version 1.0



Important Safety Instructions

Please save these instructions.

This manual contains important installation and operation instructions for the monitoring screen. Please observe these instructions and keep them located near the monitoring screen for further reference. The following symbols are used throughout the manual to indicate potentially dangerous conditions or important safety information.

WARNING

Indicates a potentially dangerous condition. Use extreme caution when performing this task.

CAUTION

Indicates a critical procedure for the safe and proper installation and operation of the monitoring screen.

NOTE

Indicates a procedure or function that is important to the safe and proper installation and operation of the monitoring screen.

■ **General Safety Information**

- DO NOT expose it to direct sunlight, rain, snow, moisture, or liquids of any type.
- DO NOT puncture, drop, crush, burn, penetrate, or strike the monitoring screen.
- DO NOT open, dismantle, or modify the monitoring screen.
- DO NOT attempt connecting the monitoring screen to other DC-DC or systems.

■ **Installation Information**

- The DC-DC are suitable for 12V Battery Banks ONLY.
- Make sure all connections going into and from the DC-DC are tight. There may be sparks when making connections, therefore, make sure there are not flammable materials or gases near installation.
- Always make sure DC-DC is in OFF position and disconnect all sources when working on any circuit associated with the DC-DC.

Table of Contents

Important Safety Instructions	01
General Information	04
Product Overview	05
Identification of Parts	05
Dimensions	06
Installation	08
Operation	14
LCD Icons	15
LCD Menu Overview	17
Voltage Interface	18
Kilowatt Interface	18
Current Interface	18
Temperature Interface	18
Working Mode	19
Parameter Setting	23
Set the Battery Type	23
Clear KWh to 0	28
Set Current Limiting	28
Change from Celsius to Fahrenheit	30
Troubleshooting	31
Technical Specifications	35

General Information

The RMS-DCDC is a high precision meter designed for DC-DC MPPT Series on board battery chargers. Featuring a backlit display and flush-mountable, it is engineered for an aesthetically clean and professional look inside vehicle cabins. Utilize the 4-key input to navigate through the backlit LCD for system information, configure charging parameters, as well as identify any error codes. The RMS-DCDC is the perfect companion offering operator feedback your 2-battery system and keeping up to date with important system information.

Key Features

- **Dual Battery Monitoring**
Stay informed on the charging status of your house and auxiliary battery and monitor overall system health.
- **Adjustable Parameters**
Program your charger settings, volts, and amps directly through the monitoring screen.
- **Plug and Play**
Simply connect an RJ45 directly to your DC-DC and let the screen take care of the rest.
- **Accurate Readings**
Precise tracking and monitoring ensure latest real-time system information.

Product Overview

■ Identification of Parts

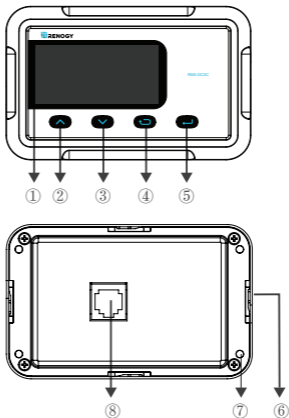

① LCD Screen

② Page Up

③ Page Down

④ Previous Page

⑤ Enter

⑥ Front Cover Plate

⑦ Mounting Holes

⑧ RJ45 Communication Port

Dimensions

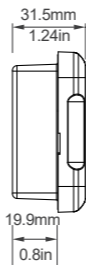
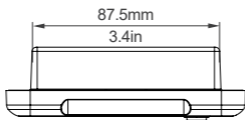
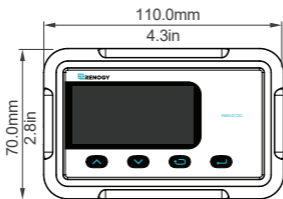

NOTE

Dimensions have a tolerance of $\pm 0.5\text{mm}$

■ Additional Components

- RJ45 Communication Cable

The RJ45 Communication Cable (5m/16.4ft) is used to connect the monitoring screen to the power supply and data transmission.

NOTE

You may use ethernet cables CAT5 or higher.

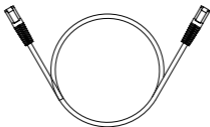

- Self-tapping Screws (4)

The Self-tapping Screws (M2.9x13) are used to fix the monitoring screen on the mounting surface.



Installation

WARNING

Before drilling, make sure there are no electrical component or other obstacles that may interfere with installation on the other side of the mounting surface.

CAUTION

Before installation, check to make sure the power is working properly. Resolve any issues before installation of monitoring screen and cable.

The RMS-DCDC requires a flush mount installation. The RMS-DC-DC's faceplate will be flush with the mounting surface and the body of the meter.

■ Preparation

Before the installation of the monitoring screen, it is recommended to have the following tools available:

- Pencil
- Drill
- Jigsaw
- Phillips screwdriver

■ Choosing an Installation Location

NOTE

The following are recommendations for installation. There will be multiple mounting methods depending on user's applications.

Clearance of at least 2 inches (50 mm) behind the unit is recommended to allow for the bending radius of the RJ45 Communication Cable that connects to the monitoring screen.

■ Mounting the Monitoring Screen

1. Remove the snap-fit Front Cover Plate from the monitoring screen.
2. Use the monitoring screen as a template to mark the screw holes and trace the cut-out area on the mounting surface with a pencil.
3. Cut out a rectangle area for the monitoring screen on the mounting surface with a jigsaw. You may also use the cut out dimension specified after Step 2.
4. Pre-drill four screw holes on the mounting surface with a drill.
5. Put the monitoring screen into the cut-out area and align the mounting holes on the monitoring screen with the pre-drilled screw holes.
6. Fix the monitoring screen on the mounting surface with the included four self-tapping screws.
7. Re-attach the snap-fit Front Cover Plate to the monitoring screen.

1

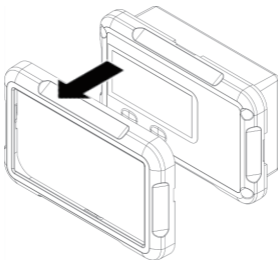

2

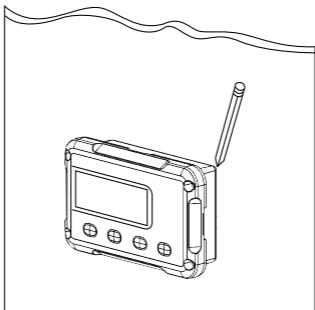

3

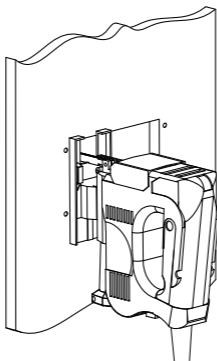

4

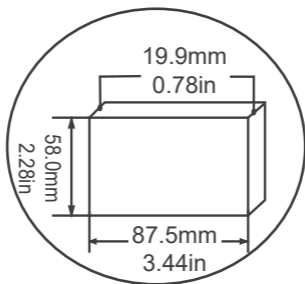

Cutout Dimensions (L x H x W):
87.5 x 58.0 x 19.9mm
(3.44 x 2.28 x 0.78in)

5

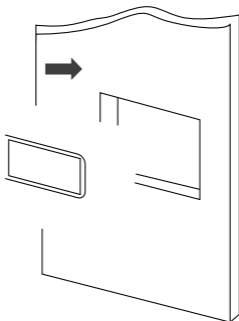

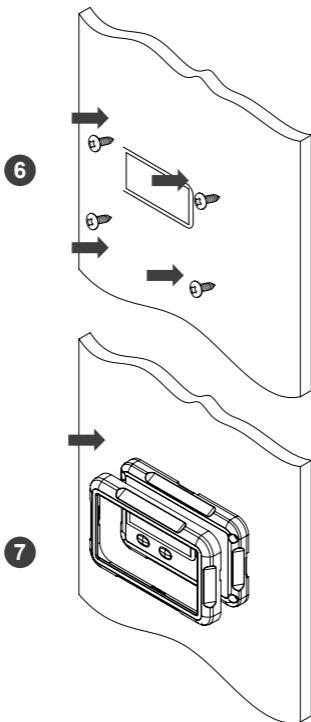



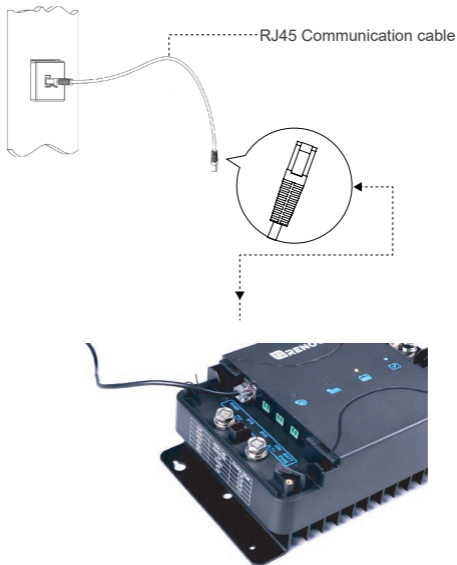

■ Connecting to the DCDC

Utilize the included RJ45 communication cable to connect between the DC-DC MPPT RS485 Port and the back of the RMS-DCDC.



Operation

Use the following keys to navigate through the monitoring screen

Key	Meaning
	Page Up
	Page Down
	Previous Page Exit Parameter Setting Mode
	Enter—Tap to Enter Parameter Setting Key—Hold for approximately 2~3 seconds to enter parameter setting mode

■ LCD Icons

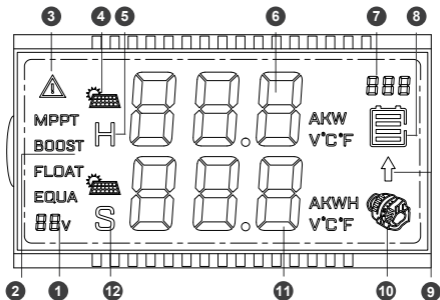

Key Features

1. System Voltage

The 12V system voltage will be illuminated while the RMS-DC-DC is powered on or during operation.

2. State of charge

Whether charging with PV, Alternator, or PV + Alternator, the charge state will reflect either MPPT, BOOST, FLOAT. Only batteries with an equalization charge will see EQUALIZE. In addition, Lithium batteries will display MPPT and Boost only.

3. System Error

Illuminates when there is a fault or error. It will be followed by an error code identifying the system error. The icon must be cleared by fixing the error code condition by troubleshooting your system.

4. Solar Charging Icon

Indicates solar is charging the house battery. Solar will take priority over alternator charging.

5. House Battery Icon

When “H” is shown with parameters, it refers to the house battery parameters.

6. Parameter Units

Total Charging Amps (A), Instant Kilowatt (KWH), Voltage (V), and Temperature (°C or °F).

7. Error Codes

System error will display a relevant error code from E0~E03、E05~E10、E12、E13. By default, E0 means no fault and will display for 3-seconds before disappearing. The following error codes may come up and will need some troubleshooting to clear them. Refer to the Troubleshooting section.

Error Code	Description
E0	Normal
E1	House Battery Over-discharged
E2	House Battery Over-voltage
E3	House Battery Low Voltage Warning
E5	House Battery Low Temperature Protection
E6	Controller High Temperature Warning
E7	House Battery High Temperature Protection
E8	Alternator Over-voltage Warning
E9	Alternator Overcurrent
E10	PV Input Over-voltage
E12	Starting Battery Polarity Reversed
E13	Solar Panel Polarity Reversed

8. House Battery SOC Icon

Indicates the estimated state of charge of the house battery. State of charge is voltage based and will be split into 4 bars each representing 25% increments for a total of 100%. Factors such as temperature, charge, and discharge can affect the state of charge. To get the most accurate SOC readings, the battery needs to rest in the open circuit state for at least 30-45min.

9. Alternator Charging Arrow

Shows that alternator is charging the starter battery or house battery circuits.

10. Alternator Icon

Displays when connected to a starter battery successfully. Charging will be indicative by the charging arrow mentioned above.

11. Battery Parameters

Battery Amps (A), Historical Kilowatt-hour Generation (KWH), Voltage (V), and Temperature (°C or °F) relevant to the starter battery.

12. Starter Battery Icon

When "S" is shown with parameters, it refers to the starter battery parameters.

■ LCD Menu Overview

Navigate through the RMS-DCDC screens by pressing the page up or page down keys.

Voltage Interface

The top line displays the house battery (DC Output) voltage as well as a graphical display of the battery using voltage-based SOC. Each bar represents 25% for a total of 100%. The bottom line shows the starter battery (DC Input) voltage.

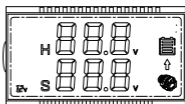

Kilowatt Interface

The top line displays instantaneous watts as a factor of kilowatts (KW). This will be the charging voltage (V) multiplied by the charging current (A) to display Kilowatts. 1 KW = 1000W.

The bottom line displays historical kilowatt hour generation information (KWH) and will accumulate the data.

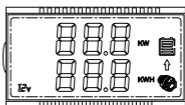

Current Interface

The top line displays overall charging current to the house battery (Only Solar, Only Alternator, or Solar + Alternator). The bottom line displays the input alternator current.

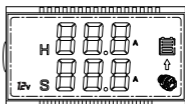

Temperature Interface

Temperature will be in Celsius ($^{\circ}\text{C}$) by default. The top line shows the house battery temperature relative to the DC-DC MPPT. When connected to the Temperature Sensor (Model RTSCC), then it will show the relevant sensor temperature. The bottom line displays the internal temperature of the DC-DC MPPT.

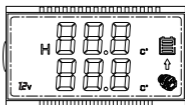

■ Working Mode

Once the RMS-DCDC is on, it will display different pages depending on the sources connected. PV Charging Mode will take priority when charging the house or starter batteries. House battery information will appear on the top line and starter battery information in the bottom line.

Only PV Charging—Starter Battery & House Battery Connected

1. PV charging requires a minimum of 15V for 10s to start charging. PV will prioritize charge to the house battery bank and charge until the lead-acid battery reaches the Float Voltage. If the house battery is Lithium, then it will reach the Boost Voltage and derate amps completely to indicate fully charged since they do not have a Float Voltage.

2. Next, PV charging will maintain the house battery and trickle charge the starter battery at 13.8V. The Generator charging arrow will appear during this time.

*Note: The maximum charging amps for the starter battery will be 50% of the Amp Rating.

3. After charging the starter battery for 1 minute, it will disconnect for 30s and check the starting battery voltage. If the starter battery drops below 12.7V, charge will continue again and stop when the actual starter battery voltage is higher than 13.2V

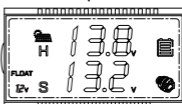
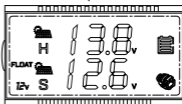
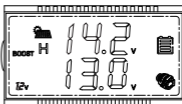

4. When and if PV charges both the house battery and starter battery at the same time, there will be a solar icon above the H and S.

Only ALT Charging—Starter Battery & House Battery Connected

1. ALT charging will follow this chart, depending on your alternator type.

Alternator Type	Starting Battery Voltage	
	Cut-in	Cut-off
Traditional Alternator	> 13.2V, for 15 seconds	< 12.7V
Smart Alternator	> 12.0V, for 15 seconds	< 11.5V

2. ALT will prioritize charge to the starter battery bank and charge until the starter battery reaches above the Cut-in Voltage.

3. Next, ALT will charge the house battery until the lead-acid battery reaches the Float Voltage. If the house battery is Lithium, ALT will need to reach the Boost Voltage and derate amps completely to indicate fully charged.

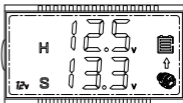
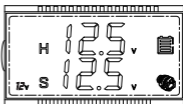

4. When no current is detected going to the House Battery, the ALT charging arrow will disappear.

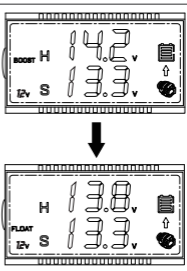

PV + ALT Charging—Starter Battery & House Battery Connected

1. PV charging will be maximized before supplementing any power with ALT charging. If PV charging alone is enough to charge the house battery, then the ALT circuit will not charge the house battery.

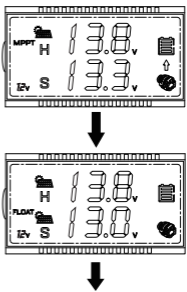

2. If PV charging is not enough to keep a constant voltage, then the ALT circuit will cut in to charge the house battery. In this fashion, dual charging is limited to 50% between PV and ALT for a total up to the rated charging amps.

3. Charging of both starter and house battery at the same time will be indicative of solar icon over the S and the ALT charging arrow.



■ Parameter Setting

- Set the Battery Type

You can change the battery type to confirm the preselected battery profiles for Gel, Flooded, Sealed, Lithium, or a User Setting. Lithium and User settings require extra steps. The battery Charging Chart can be found in the Technical Specifications.

Setting Gel, Flooded, or Sealed

1. Use the Page Up/Down keys to show the Voltage Interface. Hold down Parameter Setting Key for approximately 2-3seconds and the top line will begin flashing the battery type.
2. Use the Page Up/Down to highlight Gel, flooded (FlD), or Sealed (SlD).
3. To confirm, hold down the Parameter Setting Key for approximately 2-3seconds. The screen will clear and revert to the House Battery Voltage.

1. Hold the Param. Setting key for 2-3s until flashing

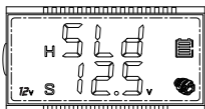

Voltage Interface

2. Use Up/Down keys to highlight battery

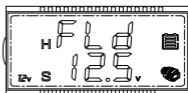
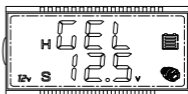
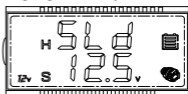

3. Confirm battery by holding Param. Setting key for 2-3s

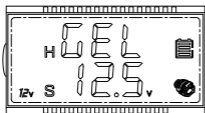

4. Confirm setting by holding Param. Setting key for 2-3s

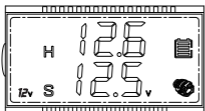

Setting Lithium

1. Use the Page Up/Down key to show the Voltage Interface. Hold down Parameter Setting Key for approximately 2-3seconds and the top line will begin flashing the battery type.
2. Use the Page Up/Down to highlight Li (Lithium).
3. Tap the Parameter Setting Key to select the Boost charge voltage. Use the Page Up/Down keys to select your desired voltage.
4. To confirm, hold down the Parameter Setting Key for approximately 2-3seconds. The screen will clear and revert to the House Battery Voltage.

1. Hold Param. Setting key for 2-3s until flashing

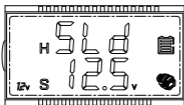

2. Use Up/Down keys to highlight Lithium "Li", then Tap Param. Setting key

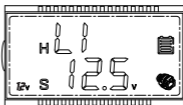

4. Confirm setting by holding Param. Setting key for 2-3s

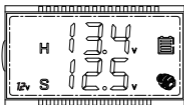

3. Use Up/Down keys to highlight Boost Voltage

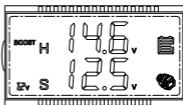

Setting User

1. Use the Page Up/Down keys to show the Voltage Interface. Hold down Parameter Setting Key for approximately 2-3seconds and the top line will begin flashing the battery type.
2. Use the Page Up/Down to highlight User (USE).
3. Tap the Parameter Setting Key to select the Boost charge voltage. Use the Page Up/Down arrows to highlight your desired voltage.
4. Tap the Parameter Setting Key again to select Float voltage. Use the Page Up/Down keys to highlight your desired voltage.
5. Tap the Parameter Setting Key to select the Equalization voltage. Use the Page Up/Down keys to highlight your desired voltage.
6. To confirm, hold down the Parameter Setting Key for approximately 2-3seconds. The screen will clear and revert to the House Battery Voltage

NOTE

Modifying parameters in User Mode or Lithium must conform to the following rules:

1. Equalization Voltage \geq Boost Voltage \geq Float Voltage
2. Overvoltage Disconnect $>$ Overvoltage Disconnect Recover

1. Hold the Param. Setting key for 2-3s until flashing

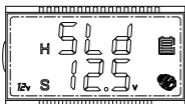

2. Use Up/Down keys to highlight "USE" then Tap Param. Setting key

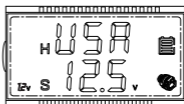

3. Use Up/Down keys to highlight boost voltage, then Tap Param Setting key

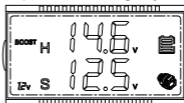

5. Use Up/Down keys to highlight equalization voltage, then Tap Param Setting key

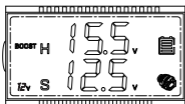

4. Use Up/Down keys to highlight float voltage, then Tap Param Setting key

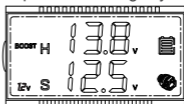

6. Confirm setting by holding Param. Setting key for 2-3s

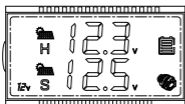

■ Clear KWh to 0

The kilowatt hour generation will automatically store historical information. To clear the values to 0:

1. Use the Page Up/Down keys to show the Kilowatts Interface. Hold down Parameter Setting Key for approximately 2-3seconds and the bottom line will begin flashing
2. Press the Page Up Key to clear the generated kilowatt generation
3. Press the Previous Page Key to revert to the kilowatts interface

1. Hold down Param. Setting Key for 2-3s until flashing

2. Press UP to clear KWH

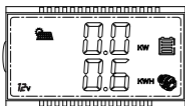

Kilowatts Interface

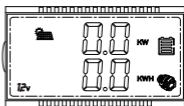

■ Set Current Limiting

Alter the rated charge current for your DCDC MPPT by setting current limiting. Current limiting can be adjusted in increments of 10A for the respective models:

DCC30S (Model: RBC30D1S)	DCC50S (Model: RBC50D1S)
30A	50A
20A	40A
10A	30A
	20A
	10A

To get started:

1. Use the Page Up/Down keys to show the Current Interface. Hold down Parameter Setting Key for approximately 2-3seconds and the top line will begin flashing rated current rating
2. Use the Page Down to highlight your desired current limit rating
3. To confirm, hold down the Parameter Setting Key for approximately 2-3seconds. The screen will clear and revert to the Current Interface

1. Hold down the Param. Setting key until flashing

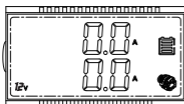

Current Interface

2. Use the Page Down to highlight your desired current limit rating

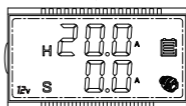
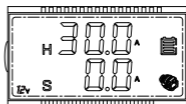

3. To confirm, hold down the Para. Setting Key for 2-3seconds.

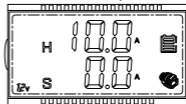
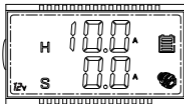

■ Change from Celsius to Fahrenheit

The default temperature is Celsius. If the RMS-DCDC is restarted, then it will refer to the default setting. Change from Celsius to Fahrenheit or vice versa:

1. Use the Page Up/Down keys to show the Temperature Interface. Hold down Parameter Setting Key for approximately 2-3seconds and the top and bottom lines will flash.
2. Tap the Parameter Setting Key to change units from Celsius to Fahrenheit.
3. To confirm, hold down the Parameter Setting Key for approximately 2-3seconds. The screen will clear and revert to your selected temperature units.

1. Hold down Param Setting Key for 2-3s until flashing

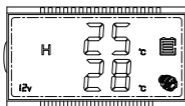

2. Tap the Param Setting key to change °C - °F or vice versa

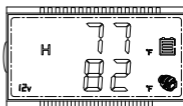

3. Confirm by holding down Param. Setting key for 2-3s

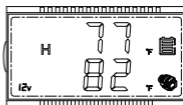

Troubleshooting

The RMS-DCDC provides you with a visual for what is occurring in the system. When the RMS-DCDC is not operating correctly, then you will need a multi-meter to validate some of the troubleshooting steps.

Problem-Solution	
RMS-DCDC does not turn on	<ol style="list-style-type: none"> 1. Make sure you are using the provided cable or that it is a CAT5 or higher if using your own 2. Firmly press the ethernet jack onto the back port on the RMS-DCDC until you hear a clicking sound. Do the same when connecting it to the RS485 port on the DC-DC MPPT. 3. Make sure the DC-DC MPPT is also powered on prior to connecting the cable. 4. Contact Support.
Error Codes	Troubleshooting
E1 House Battery Over-discharged	<ol style="list-style-type: none"> 1. Ensure you have a charging source through alternator or solar as the battery needs to be charged. 2. Disconnect any loads from the house battery and allow it to recharge. 3. Use a multi-meter to measure the battery and then the battery terminals to determine consistency, any inconsistency could be a break in the line.
E2 House Battery Over-voltage	<ol style="list-style-type: none"> 1. Double check your battery type setting to determine whether it is correctly set. 2. Use a multi-meter to determine and validate the high charging voltage. 3. Disconnect any extraneous chargers. 4. Contact support if over-charge continues.

<p>E3 House Battery Low Voltage Warning</p>	<ol style="list-style-type: none"> 1.The warning is letting you know that you're using more than your battery can supply. 2.It is recommended to limit your load use to not run the battery to empty 3.It is also recommended to connect a charging source, solar or alternator, to slow down the battery draining.
<p>E5 House Battery Low Temperature Protection</p>	<ol style="list-style-type: none"> 1.The temperature sensor on the DC-DC MPPT or on the remote sensor (Model: RTSCC) is detecting low temperature at the house battery and has ceased charging. 2.Ensure you're not using the RTSCC on lithium batteries. 3.Lithium battery may have reached a freezing point and cut off charge. Relocate the battery if conditions are freezing. 4. The condition will recover upon temperature getting warmer or if relocating the DC-DC MPPT in a better ambient temperature to continue normal work mode.
<p>E7 House Battery High Temperature</p>	<ol style="list-style-type: none"> 1.The temperature sensor on the DC-DC MPPT or on the remote sensor (Model: RTSCC) is detecting high temperature and has cease charging. 2.Check for loose connections and ensure no heating sources around the battery. 3.The condition will recover upon temperature getting cooler or if relocating the DC-DC MPPT in a better ambient temperature to continue normal work mode.
<p>E6 Controller High Temperature</p>	<ol style="list-style-type: none"> 1.The temperature sensor on the DC-DC MPPT or on the remote sensor (Model: RTSCC) is detecting high temperature and has cease charging. 2.Limit the charge current to cool down the work mode of the DC-DC MPPT. 3.The condition will recover upon temperature getting cooler or if relocating the DC-DC MPPT in a better ambient temperature location to continue normal work mode.

<p>E8 Alternator Over-voltage Protection</p>	<ol style="list-style-type: none"> 1. Disconnect the starter battery from the circuit 2. Double check the alternator voltage does not exceed 16.5V.
<p>E9 Alternator Overcurrent</p>	<ol style="list-style-type: none"> 1. Disconnect the starter battery from the circuit 2. Check on the alternator charging rating to ensure not over the 30A 50A limit.
<p>E10 PV Input Over-voltage</p>	<ol style="list-style-type: none"> 1. The panel is producing voltage higher than the 25V operating voltage of the DC-DC MPPT. 2. Double check your connections and make sure you're not exceeding 25.5Volts open. Use a multimeter to measure the panel leads and confirm not over voltage. 3. Contact support if overvoltage condition continues and the operating voltage is under 24.5V
<p>E12 Starting Battery Polarity Reversed</p>	<ol style="list-style-type: none"> 1. Your battery poles are reversed. 2. Fix the connection to resume normal working mode. Use a multi-meter to measure the correct polarity before connecting to the DC-DC MPPT and ensure proper connection. 3. Assuming correct polarity from the Multimeter, negative readings on the multi-meter indicate reverse polarity. 4. Fix the connection to continue normal operation.
<p>E13 Solar Panel Polarity Reversed</p>	<ol style="list-style-type: none"> 1. Your solar panel poles are reversed. 2. Fix the connection to resume normal working mode. Use a multi-meter to measure the correct polarity before connecting to the DC-DC MPPT and ensure proper connection. 3. Assuming correct polarity from the Multimeter, negative readings on the multi-meter indicate reverse polarity. 4. Fix the connection to continue normal operation

Technical Specifications

Electrical Specifications

Supply Voltage	5VDC
Supply Current	30mA
Power Consumption	< 1W
Operating Temperature Range	-4°F ~113°F / -20°C ~45°C
Voltage Accuracy	±0.1V
Current Accuracy	±0.1A

Mechanical Specifications

Communication Port	RJ45 (RS485 Protocol)
Display	Backlit LCD
User Interface	2key input, 1main power switch
Mounting System	Wall Mount
Dimension	2.8 x 4.3 x 1.24 inch 70 x 110 x 31.5 mm
Weight	0.14 lbs / 62 g
Mounting Screw	M2.9x13
Certifications	FCC Class B Part 15

Battery Charging Chart

Battery Type Parameters	SLD/AGM	GEL	FLD	LI (LFP)	USER (Default)	Custom Range (USER/LI)
Over-voltage Warning	16V	16V	16V	16V	16V	N/A
Charging Limit Voltage	15.5V	15.5V	15.5V	15.5V	15.5V	N/A
Over-voltage Recover	15V	15V	15V	15V	15V	N/A
Boost Charge Voltage	14.6V	14.2V	14.6V	14.4V (adjustable)	14.6V (adjustable)	13.2V-15.5V
Float Charge Voltage	13.8V	13.8V	13.8V	---	13.8V (adjustable)	13.2V-15.5V
Equalization Voltage	---	---	14.8V	---	14.6V (adjustable)	13.2V-15.5V
Boost Return Voltage	13.2V	13.2V	13.2V	13.2V	13.2V	N/A
Under Voltage Warning	12V	12V	12V	12.1V	12V	N/A
Under Voltage Recover	12.2V	12.2V	12.2V	12.2V	12.2V	N/A
Over-discharge Warning	11.1V	11.1V	11.1V	11.1V	11.1V	N/A
Over-discharge Recover	12.6V	12.6V	12.6V	12.6V	12.6V	N/A
Boost Duration	120min	120min	120min	Variable until Full	120min	0~120 min
Equalization Interval	---	---	28 days	---	28 days	0-30 days
Over-voltage Recover	---	---	120min	---	0-120 min	0~120 min

NOTE

User Mode is an extra feature accessed via App Development Only or Monitoring Screen. However, Boost Duration, Equalization Interval, and Equalization Duration can only be programmed through App Development.

The battery charging parameters assume conditions to be 77 °F / 25 °C in 12V systems.

NOTE

This equipment has been tested and found to comply with the limits for a class B digital device, pursuant to part 15 of the FCC Rules. These limits are designed to provide reasonable protection against harmful interference in a residential installation. This equipment generates, uses and can radiate radio frequency energy and if not installed and used in accordance with the instructions, may cause harmful interference to radio communications. However, there is no guarantee that interference will not occur in a particular installation. If this equipment does cause harmful interference to radio or television reception, which can be determined by turning the equipment off and on, the user is encouraged to try to correct the interference by one or more of the following measures:

- Reorient or relocate the receiving antenna.
- Increase the separation between the equipment and receiver.
- Connect the equipment into an outlet on a circuit different from that to which the receiver is connected.
- Consult the dealer or an experienced radio/TV technician for help.

This device complies with Part 15 of the FCC Rules.

Operation is subject to the following two conditions:



- (1) this device may not cause harmful interference.
- (2) this device must accept any interference received, including interference that may cause undesired operation.

Renogy reserves the right to change the contents of this manual without notice.

US |  2775 E Philadelphia St, Ontario, CA 91761, USA
 909-287-7111
 www.renogy.com
 support@renogy.com

CN |  苏州高新区科技城培源路1号5号楼-4
 400-6636-695
 <https://www.renogy.cn>
 support@renogy.cn

JP |  <https://www.renogy.jp>
 supportjp@renogy.com

CA |  <https://ca.renogy.com>
 supportca@renogy.com

AU |  <https://au.renogy.com>
 supportau@renogy.com

UK |  <https://uk.renogy.com>
 supportuk@renogy.com

DE |  <https://de.renogy.com>
 supportde@renogy.com