

PROJECTA

INTELLI-WAVE

2000W/3000W PURE SINE WAVE INVERTER



P/No. IP2000, IP2000-24, IP3000, IP3000-24V2

IMPORTANT SAFETY INFORMATION

Please read this manual thoroughly before use and store in a safe place for future reference.

WARNINGS

- For indoor use out of weather only.
- For use with negatively earthed vehicles & systems only.
- Internally bonded for safety, battery DC negative to case & AC socket earth.
- Hazardous voltage inside – do not attempt to open, repair or use if damaged.
- Only connect 230/240V AC appliances that are in safe condition.
- This appliance is not intended for use by young children or infirm persons unless they have been adequately supervised by a responsible person to ensure that they can use the appliance safely.
- Young children should be supervised to ensure that they do not play with the appliance.
- For independent use, do not connect to buildings.
- All 240V AC wiring shall be completed by a licensed electrician.

CAUTIONS

- Batteries should be mounted in a separate well-vented enclosure.
- Even though the inverter is powered from a battery, it still produces dangerously high voltage AC power and has the potential to fatally injure if incorrectly installed or used.
- Double check battery negative and positive posts before making any connection; a wrong connection (reverse polarity) will cause the fuse/s to blow and may damage the inverter.
- A small spark (arc) can occur when making the final battery connection, this is most common when the inverter has not been used for some time. This spark is caused by the inverter's large capacitors charging quickly. To minimise this, make the last connection quickly and completely.
- Batteries can be dangerous; follow all battery manufacturer's instructions and warnings.
- Never operate the inverter without the DC negative input connected direct to the battery and never install a fuse, circuit breaker or battery switch in the negative supply line.

FEATURES

PURE SINE WAVE OUTPUT

There are two different types of inverters, modified sine wave and pure sine wave. The difference between the two is how closely the output replicates mains power.

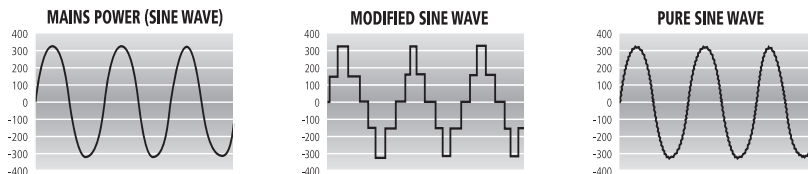

Logically it follows that the process used in a pure sine wave inverter is more complex than a modified sine wave inverter and subsequently more expensive. Most electric appliances operate unaffected on a modified sine wave and hence they are more common.

Pure sine wave inverters are best for use on medical equipment and sensitive electrical appliances. They allow you to watch television without static, play your favourite game on an Xbox™, Playstation™ or Wii™ and run a fluoro, all of which may not operate properly on a modified sine wave inverter.

AC TRANSFER SWITCH

The built in automatic transfer switch ensures a quick transfer of power when switching between mains and battery power. The automatic change over function eliminates the need to manually swap over AC plugs or be switching dials between the two power sources. When mains power is available, mains power passes through the inverter to power the accessories directly. When the mains power is disconnected the appliance automatically switches across to inverter power.

ECO MODE

When power is not being drawn from the inverter it will automatically switch to ECO Mode reducing power consumption & extending battery run time.

RCD SAFETY SWITCH

The Residual Current Device (RCD) switch detects if there is an earth leakage and will automatically disconnect all power sockets protecting from electrocution. Meets Australian Standards for AS/NZS4763:2011 (portable inverters) and AS3001 (caravan installation)

REMOTE CONTROL DISPLAY

Control and monitor the inverter's performance from a remote control display allowing the inverter to be mounted flush or surface mounted out of sight. Ideal for use in caravans, motor homes and boats.

BI-COLOUR L.E.D DISPLAY

THERMOSTATICALLY CONTROLLED 3 SPEED COOLING FAN

PROTECTION

- Low input voltage
- High input voltage
- Low battery alarm
- Over temperature
- Overload

SPECIFICATIONS

| P/No. | IP2000 | IP2000-24 |
|---------------------------------|---|--|
| Input | 12VDC Battery/Vehicle (9.75–15.5VDC) | 24VDC Battery/Vehicle (19.5–31.0VDC) |
| Input Current (Max DC Amps) | 200A | 100A |
| No Load Current Draw | 1000mA | 400mA |
| Remote Standby Current Draw | 2mA | 2mA |
| ECO Mode Current Draw | | 10mA |
| ECO Mode Sleep | | <1W |
| ECO Mode Wake | | >6W |
| Output | | 240VAC 50Hz |
| Continuous Power (Watts) | | 2000W |
| Peak Power (Watts) | | 4000W |
| Inverter Classification | | RCD Protected Inverter |
| Output Waveform | | Pure Sine Wave |
| Efficiency | | 85–90% |
| Low Battery Alarm/Shutdown | Alarm 10.5V, Shutdown 9.75V (±0.2V) | Alarm 21.0V, Shutdown 19.5V (±0.2V) |
| Cooling Fan | | Automatic Temperature Controlled |
| Thermal Shutdown | | 65°C (±5°C) |
| Internal Fuse (non-replaceable) | | 250A ANM |
| Recommended inline fuse | 250A | 150A |
| Size (mm) | | 452 x 250 x 105mm |
| Weight | | 7.9kg |
| Approvals | | Electrical Safety (AS/NZS4763:2011), EMC |

SPECIFICATION (CONTINUED)

| P/No. | IP3000 | IP3000-24V2 |
|---------------------------------|--|--|
| Input | 12VDC Battery/Vehicle (9.75–15.5VDC) | 24VDC Battery/Vehicle (19.5–31.0VDC) |
| Input Current (Max DC Amps) | 300A | 150A |
| No Load Current Draw | 650mA | 350mA |
| Remote Standby Current Draw | 2mA | 2mA |
| ECO Mode Current Draw | | 10mA |
| ECO Mode Sleep | | <1W |
| ECO Mode Wake | | >6W |
| Output | | 240VAC 50Hz |
| Continuous Power (Watts) | | 3000W |
| Peak Power (Watts) | | 6000W |
| Inverter Classification | | RCD Protected Inverter |
| Output Waveform | | Pure Sine Wave |
| Efficiency | | 85–90% |
| Low Battery Alarm/Shutdown | Alarm 10.5V, Shutdown 9.75V ($\pm 0.25V$) | Alarm 21.0V, Shutdown 19.5V ($\pm 0.25V$) |
| Cooling Fan | | Automatic Temperature Controlled |
| Thermal Shutdown | | 65°C ($\pm 5^\circ C$) |
| Internal Fuse (non-replaceable) | 525A | 300A |
| Recommended inline fuse | 350A | 200A |
| Size (mm) | | 535 x 250 x 105mm |
| Weight | | 9.65kg |
| Approvals | | Electrical Safety (AS/NZS4763:2011), EMC |

PRODUCT OVERVIEW

FRONT VIEW

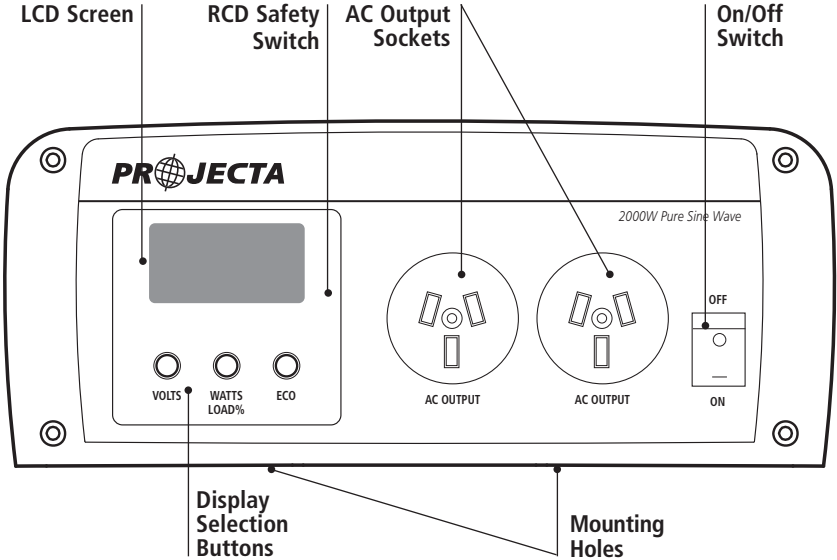

REAR VIEW

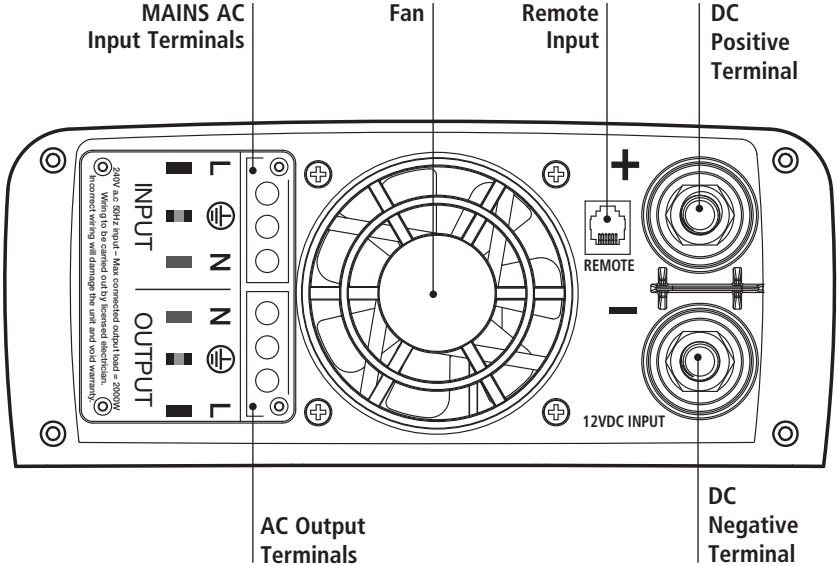

MOUNTING INSTRUCTIONS

Intelli-Wave inverters are designed for indoor, out of weather use only. During operation, the inverter should be in a dry, cool and well-ventilated area as close to the batteries as possible, but not in the same compartment as the batteries. Ensure the inverter is away from flammable materials and fumes.

The inverter end plates include a mounting flange for easy mounting. If permanently fixed, the inverter should be mounted to a suitable horizontal or vertical panel, with at least 10cm clearance from the end plates to provide adequate ventilation for the cooling fan.

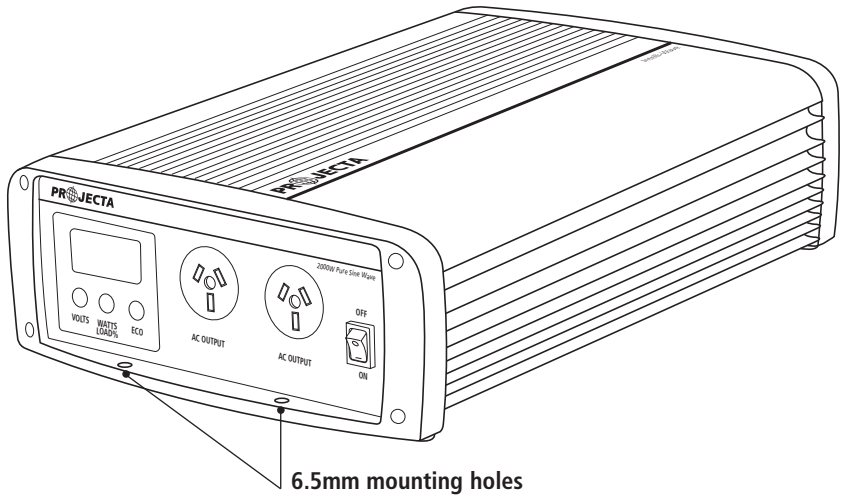

| Part No. | Inverter Dimensions | | |
|----------------------|---------------------|-------|--------|
| | Length | Width | Height |
| IP2000 & IP2000-24 | 478mm | 250mm | 105mm |
| IP3000 & IP3000-24V2 | 535mm | 250mm | 105mm |

CONNECTING THE DC CABLES TO THE INVERTER

It is important to use suitable cable lengths and sizes to get the most out of your inverter. Use of cable that is too thin or too long will result in voltage drop between the battery and inverter, and may trigger low voltage warnings and inverter shutdowns.

It is recommended to place cable in corrugated conduit to protect from damage.

The following table lists suitable cable sizes for different cable lengths available from Projecta.

| Cable Specifications | | |
|----------------------|---------------------------------|------------------------|
| Cable Length | 0–3m | 3–6m |
| IP2000 | IWK6 (3m, 49mm ²) | Not Recommended |
| IP2000-24 | IWK3 (3m, 32mm ²) | 6m, 64mm ² |
| IP3000 | IWK8 (1.5m, 95mm ²) | Not Recommended |
| IP3000-24V2 | IWK9 (1.5m, 70mm ²) | Not Recommended |

1. Prepare all cable ends with cable lugs.
2. Install a circuit breaker or high current fuse and fuse holder in the positive line as close to the battery as possible. The following fuse & fuse holder is available from Projecta
IP2000: P/No. IFB-250 (250A fuse and holder) 12 Volt
IP3000: P/No. IFB-350 (350A fuse and holder) 12 Volt
IP2000-24: P/No. IFB-150 (150A fuse and holder) 24 Volt
IP3000-24V2: P/No. IFB-200 (200A fuse and holder) 24 Volt
3. Make sure the inverter On/Off switch is turned OFF.
4. Connect the cables to the DC input terminals on the rear of the inverter.
The red terminal is positive (+) and the black terminal is negative (-).
 - a. Connect the positive cable to the inverter and battery positive terminals.
 - b. Connect the negative cable to the inverter and battery negative terminals.
5. The inverter is earthed through the negative DC input cable. Additional earthing can be wired from the DC negative terminal.

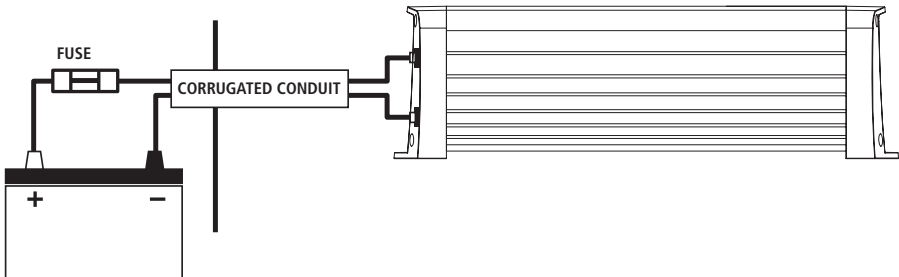

CONNECTING THE AC CABLES TO THE INVERTER

Note: Ensure a licensed Electrician wires the 240V AC mains and output terminals to and from the inverter. If the inverter is being installed in to a caravan/camper van ensure the unit & wiring is installed to AS3001.

WIRING AC POWER FROM THE INVERTER

AC output power can be wired directly from the OUTPUT terminals of the inverter allowing connection to external GPO's in addition to the outputs located on the front of the IP2000/IP3000 unit.

1. Ensure the inverter is turned off and disconnected from DC & AC mains power.
2. To gain access to the OUTPUT terminals remove the cover located at the back of the unit using a phillips head screw driver as per illustration below.

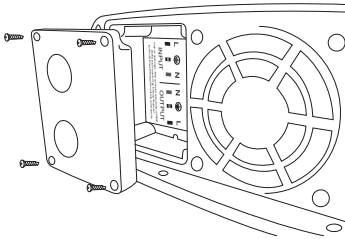

3. Select suitable size cable gland/conduit fittings (16mm or 20mm) & cable to be wired to the INPUT terminals. Ensure cable multi strand cable is used as per AS3001.
4. Once the suitable size cable glands/conduit fitting are selected, push through the appropriate size pre cut holes located on the rear cover & install the fitting.
5. Strip the cable back and feed through the cable glands/conduit fittings, then hard wire the cables to the OUTPUT terminals. Ensure cable is wired to the OUTPUT terminals as per the below illustration:

Earth (Green/Yellow) connect to: 
Neutral (Blue) connect to: N
Active (Brown) connect to: L

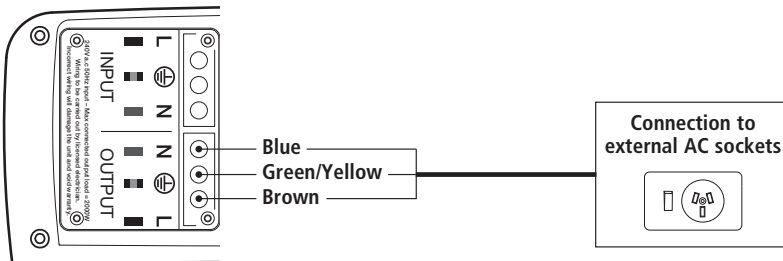

6. Refit rear cover and tighten cable gland/conduit fitting.

WIRING AC MAINS POWER TO THE INVERTER

1. Ensure the inverter is turned off and disconnected from DC power, also ensure AC mains wiring to be connected to the inverter is isolated and safe to work with.
2. To gain access to the INPUT terminals remove the cover located at the back of the unit using a phillips head screw driver.
3. Select suitable size cable glands/conduit fittings (16mm or 20mm) & cable to be wired to the INPUT terminals. Ensure multi strand cable is used as per AS3001.
4. Once the suitable size cable glands/conduit fittings are selected, push through the appropriate size pre cut holes located on the rear cover & install the fitting.
5. Strip the cable back and feed through the cable glands/conduit fitting, then hard wire the cables to the INPUT terminals. Ensure cable is wired to the INPUT terminal as per the below illustration:

Earth (Green/Yellow) connect to: 

Neutral (Blue) connect to: N

Active (Brown) connect to: L

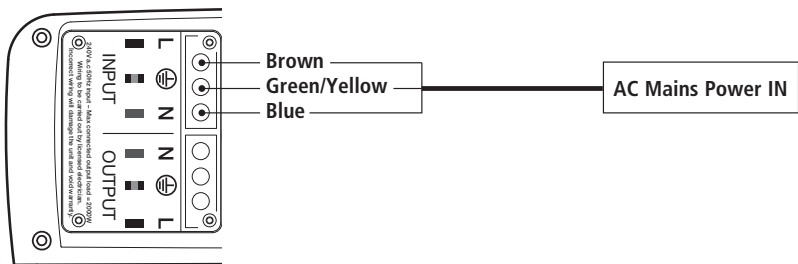

6. Refit rear cover and tighten cable gland/conduit fitting.

REMOTE CONTROL DISPLAY

To install the remote control, insert the data plug into the data socket at the rear of the inverter. **To operate the inverter using the remote, the inverter On/Off switch must be turned to ON.**

The remote is equipped with an LCD screen identical to the inverter, as well a bi-colour status L.E.D and audible alarm. During normal operation, the LCD screen will default to the VOLTS display (input battery voltage). Alternative information can be displayed by pressing the relevant buttons:

VOLTS: Displays input battery voltage

WATTS & LOAD%: Displays the amount of power being drawn by the appliance (in Watts) & indicates the percentage of total capacity being drawn by the appliance (Load). Press the WATTS/LOAD% button on the front of the unit to alternate between Watts and Load display information.

ECO: Displays ECO mode status settings.

In the event of a fault or error, the alarm will sound, the LCD screen will display one of several fault codes and L.E.D will illuminate various signals. Refer to the table on the page 13 for fault codes and L.E.D signals.

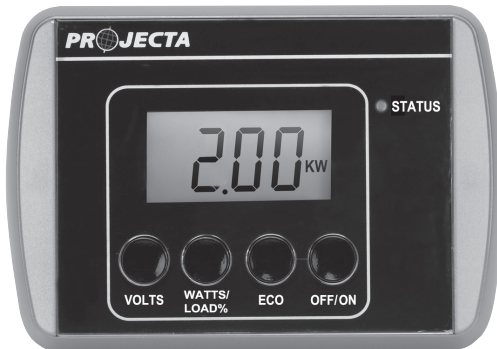

MOUNTING REMOTE CONTROL

FLUSH MOUNT

- Cut a 93mm x 70mm hole into the desired mounting surface to suit the supplied mounting plate.
- Position the mounting plate into the hole with the side labelled 'FLUSH MOUNT' facing outwards and screw the supplied screws into the mounting surface as per the below illustration.
- Clip the remote control into the mounting plate.

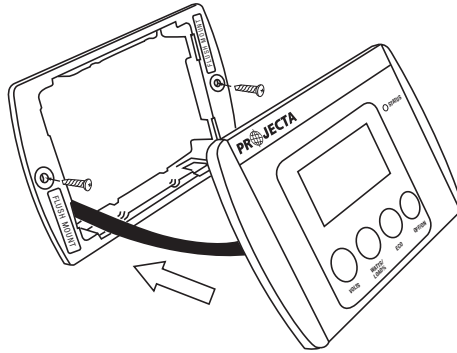

SURFACE MOUNT

- Position the supplied mounting plate onto the desired mounting surface so the side labelled 'SURFACE MOUNT' is facing outwards and screw the supplied screws into the mounting surface as per the below illustration.
- Drill a 15mm cable exit hole into the mounting surface, ensure cable exit hole is positioned directly in the middle of the mounting plate.
- Position the remote control into the remote control surround as per the below illustration and clip into the mounting plate.

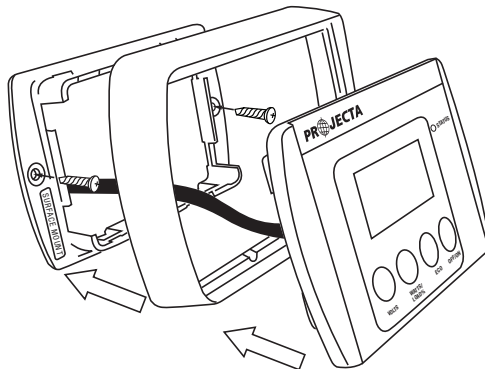

REMOVING REMOTE CONTROL

FLUSH MOUNT

1. Pull the remote control sideways and firmly lift
2. The remote will click out of place

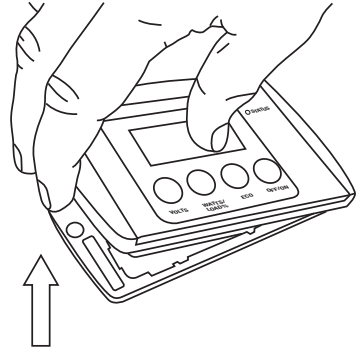
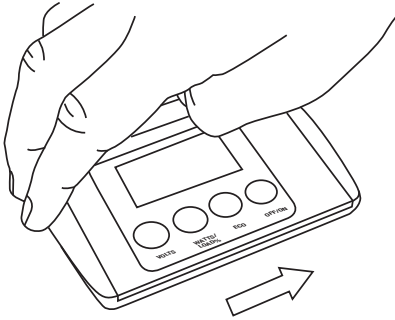

SURFACE MOUNT

1. Holding the remote on either side, push upwards.
2. Squeeze the sides together to lift away.

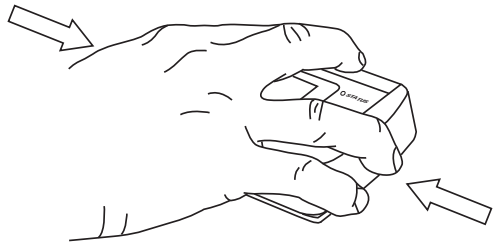
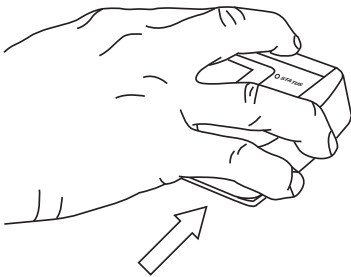

UNDERSTANDING YOUR INVERTER

These inverters are equipped with an audible alarm and a multi-function LCD screen with selection buttons allowing you to monitor the inverter’s performance. During normal operation, the LCD screen will default to the VOLTS display (input battery voltage). Alternative information can be displayed by pressing the relevant buttons:

VOLTS: Displays input battery voltage

WATTS & LOAD%: Displays the amount of power being drawn by the appliance (in Watts) & indicates the percentage of total capacity being drawn by the appliance (Load). Press the WATTS/LOAD% button on the front of the unit to alternate between Watts and Load display information.

ECO: Displays ECO mode status settings.

In the event of a fault or error, the alarm will sound and the LCD screen will display one of several fault codes.

| STATUS | CODE | REMOTE L.E.D SIGNAL | ALARM |
|-------------------------------|----------|----------------------------|-------|
| Operating from mains AC power | MAINS AC | Green ○ | – |
| Operating from DC power | INVERTER | Green ○ | – |
| Low Battery Voltage | Lb | Green ○ | ON |
| Low Battery Voltage Shutdown | Lb | Green/Red (Flashing) ○ / ● | ON |
| Over Temperature Shutdown | OTP | Red ● | ON |
| Output Short Circuit | OSP | Red ● | ON |
| Overload Shutdown | OPP | Red (Flashing) ● | ON |
| High Battery Voltage Shutdown | Hb | Green (Flashing) ○ | ON |

Note: In the event of the RCD switch tripping the inverter will not sound an alarm, a green indicator will be present above the switch. This indicates the AC mains output is off and safe

OPERATING INSTRUCTIONS

To operate the inverter turn the inverters On/Off switch to ON. The inverter will beep momentarily while it carries out a brief self-analysis before supplying power to the AC socket. To turn off, turn the inverter On/Off switch to OFF.

Note: Ensure the RCD Switch is down, the red indicator will be showing.

Note: Where possible the inverter will automatically select 240V AC mains power rather than DC battery power during operation.

To help prevent the inverter being overloaded:

1. Ensure appliances are turned off before turning the inverter on.
2. If multiple appliances are being run, turn on one at a time.

ECO MODE

Eco mode is designed to help reduce power consumption extending battery run time (1000mA to 10mA). ECO mode can be activated via pressing ECO button located on the front of the unit. Four different settings are available depending on the users application/requirements.

ECO MODE SETTINGS:

off: ECO mode will not activate.

1 Hr: After no load being drawn from the inverter for a period of 1 hour the inverter will go into ECO mode.

3 Hr: After no load being drawn from the inverter for a period of 3 hours the inverter will go into ECO mode.

on: After no load being drawn from the inverter for a period of 30 seconds the inverter will go into ECO mode.

To select a setting press the ECO button until the required status appears on the L.E.D screen located on the front of the unit.

If ECO mode is set to 1Hr, 3Hr or ON the inverter is waiting for a load less than 0.5W before it starts timing. To wake up the inverter from ECO mode (Power save mode), press any of the buttons on the front panel or the remote or alternatively connect a device that draws more than 5-8W to the inverter. Whilst the inverter is in the ECO/Power save mode it will automatically check if a device is connected to the inverter every 5 seconds.

FAULTS & ERRORS

| Problem | Possible Cause | Solution |
|---------------------------|---|---|
| Low battery voltage | Input battery voltage is below 10.5V (12V), 21V (24V) | a) Recharge battery b) Battery may be too small. Refer to pg 16 for recommended battery sizes c) Check cable connections and that cable sizes are sufficient (see pg 6) |
| Low battery Shutdown | a) The input battery voltage is below 10V (12V), 19.5V (24V) b) There is a voltage drop between the battery and the inverter | a) Recharge battery immediately. Failure to do so may cause permanent battery damage b) Check cable connections and that cable sizes are sufficient (see pg 6) |
| Over temperature shutdown | Internal temperature is above 65°C | Turn off inverter and allow to cool |
| Overload shutdown | The inverter is overloaded: a) there are too many appliances running, or b) the appliance is not suitable for this inverter | Turn off inverter to reset. Check the (combined) power usage of the appliance/s is suitable for this inverter |
| High battery shutdown | Input battery voltage is above 15.5V (12V) or 31.0V (24V) | a) Confirm input battery is correct. b) Check that a battery charger is not connected to the battery |
| Output short circuit | Appliance may have an electrical fault | Remove appliance and have it checked by a qualified technician |
| Fan Error | Object may be stuck in fan | Inspect fan area at rear of unit to ensure no object is obstructing fan movement |

UNDERSTANDING YOUR POWER REQUIREMENTS

POWER REQUIREMENTS OF YOUR APPLIANCE/S:

All appliances have a rating plate that shows the amount of power (Watts) used or the current (Amps) drawn under normal use.

The following table shows the maximum combined AC Watts or AC Amps which can be run by the inverter.

| P/No. | IP2000 | IP3000 |
|----------------------------------|--------|--------|
| AC Combined maximum load (Watts) | 2000W | 3000W |
| AC Combined maximum load (Amps) | 8.3A | 12.5A |

Some appliances that use an electric motor or transformer may draw up to 10 times their power rating when first turned on. These are called inductive loads and are the most difficult for the inverter to run. Contact your appliance manufacturer for further advice.

SUITABLE POWER SOURCE

In order to operate the inverter and supply power to an appliance a suitable power supply is required, typically a vehicle or caravan battery, portable power pack or an independent lead acid battery. For most applications, a deep cycle battery is recommended for best performance.

The size of the battery used will determine how long the inverter will supply power to an appliance and how well the inverter will perform. Most batteries are marked with their size in Amp hours (Ah) or Cold Cranking Amps (CCA).

Because inverters are capable of drawing high currents the inverter should only be connected to a suitable size battery. Connection to an undersized battery could damage the battery and will result in the inverter shutting down within a short period due to low battery voltage.

The amount of power drawn from the battery is proportional to the inverter load.

| P/No. | IP2000 | IP3000 |
|---|---------------|---------------|
| Minimum recommended battery size | 85Ah (600CCA) | 95Ah (700CCA) |
| Run time with maximum load and minimum battery size | 5 min | 4 min |
| Run time for a 100W globe with minimum battery size | 7 Hours | 8 Hours |
| Ideal battery size | 85-400Ah | 95-600Ah |

TROUBLESHOOTING/FAQ:

Q. Why does the inverter turn itself off?

A. If the inverter's audible alarm sounds and a fault L.E.D illuminates, this indicates that there is a fault or error, and the inverter may turn off. Most commonly this would be caused by an appliance that is drawing too much power (overloading), low battery voltage or voltage drop due to insufficient size cables or poor connections (refer to 'Faults & Errors' table, page 15).

Q. The Inverter will not run my appliance even though the appliance draws less power (Watts) than the size of the inverter?

A. Electrical appliances can be divided into three groups by the way they draw energy (current) from their power supply. These groups are "Resistive", "Inductive" and "Capacitive" appliances or also called "loads". Some appliances may draw all three types of power.

Resistive Loads such as normal incandescent lights (wire filament) always draw a constant power (watts) from the power supply, that is a 100 Watt light will draw approximately 100 Watts from the power supply at all times. Resistive loads are the easiest appliances for an inverter to run.

Inductive Loads such as a refrigerator (Electric Motor) require a large rush of power (surge current) to start and then usually draw a more constant power once running. Inductive loads contain coils of wire (motors, transformers, ballasts, solenoids). When the power is first turned on, these coils of wire draw a large surge current which forms the magnetic flux (magnetic field) which allows these appliances to work. This magnetic flux is a kind of stored energy.

The most common inductive appliances are: fridges, air compressors, transformers/chargers, pumps, power tools and fluorescent lights. These appliances can draw up to 10 times their normal running power to start up; that is to run a 80W fridge you may need a 600 or 1000 Watt inverter.

Capacitive Loads such as many TV's or many electronic appliances require a large surge current to start only when they have not been used for a while. This is often due to large capacitors in the power supply that must be quickly charged when the appliance is turned on. If the appliance is not used for a few days these capacitors slowly go flat. Resetting the inverter a couple of times may allow these appliances to work.

There are some appliances such as large refrigerators, air conditioners and other pump driven appliances that have extremely high start up currents, because they have an inductive motor that must start under load. These appliances are not recommended for use with an inverter. They should be powered by an engine driven generator.

Q. Why does it damage the inverter if the battery leads are reverse-connected?

A. Your inverter uses sophisticated electronics to convert DC battery power to AC mains power. If you accidentally connect the inverter to the battery incorrectly (reverse polarity) a large current will be drawn by the inverter which will blow the protection fuse. As this occurs some of the high current could damage sensitive electronic components. Because of this risk it is important to always double-check the battery polarity before making any connections.

Q. How do I check or change the fuses?

A. Intelli-Wave inverters contain internal fuses and should only be checked or replaced by a qualified electrical appliance repairer.
THE DC/AC SUPPLY MUST BE DISCONNECTED BEFORE ANY REPAIR, THEN TURN THE ON/OFF SWITCH OF THE INVERTER "ON" TO DISCHARGE THE CAPACITORS.

Q. Why does the fan only operate sometimes?

A. Intelli-Wave inverters feature a temperature controlled automatic cooling fan that only operates when needed. This allows the inverter to run very quietly for most of the time.

Q. Can I run laptop computers and other sensitive electrical appliances?

A. Yes. Intelli-Wave's pure sine wave output is suitable for medical equipment and sensitive electrical appliances. They allow you to watch television without static, operate computers and gaming consoles and run fluorescent lights.

Q. Why Does my inverter keep turning off?

A. ECO mode may be set on your inverter causing it to automatically switch to power save mode, check ECO setting by pressing the ECO button on the front of the unit.

WARRANTY STATEMENT

Applicable only to product sold in Australia

Brown & Watson International Pty Ltd of 1500 Ferntree Gully Road, Knoxfield, Vic., telephone (03) 9730 6000, fax (03) 9730 6050, warrants that all products described in its current catalogue (save and except for all bulbs and lenses whether made of glass or some other substance) will under normal use and service be free of failures in material and workmanship for a period of two (2) year (unless this period has been extended as indicated elsewhere) from the date of the original purchase by the consumer as marked on the invoice. This warranty does not cover ordinary wear and tear, abuse, alteration of products or damage caused by the consumer.

To make a warranty claim the consumer must deliver the product at their cost to the original place of purchase or to any other place which may be nominated by either BWI or the retailer from where the product was bought in order that a warranty assessment may be performed. The consumer must also deliver the original invoice evidencing the date and place of purchase together with an explanation in writing as to the nature of the claim.

In the event that the claim is determined to be for a minor failure of the product then BWI reserves the right to repair or replace it at its discretion. In the event that a major failure is determined the consumer will be entitled to a replacement or a refund as well as compensation for any other reasonably foreseeable loss or damage.

This warranty is in addition to any other rights or remedies that the consumer may have under State or Federal legislation.

IMPORTANT NOTE

Our goods come with guarantees that cannot be excluded under the Australian Consumer Law. You are entitled to a replacement or refund for a major failure and compensation for any other reasonably foreseeable loss or damage. You are also entitled to have the goods repaired or replaced if the goods fail to be of acceptable quality and the failure does not amount to a major failure.

Distributed by

AUSTRALIA

Brown & Watson International Pty. Ltd.

Knoxfield Victoria 3180

Phone: (03) 9730 6000

Fax: (03) 9730 6050

National Toll Free: 1800 113 443

NEW ZEALAND OFFICE

Griffiths Equipment Ltd.

19 Bell Avenue,

Mount Wellington,

Auckland 1060, New Zealand

Phone: (09) 525 4575

Fax: (09) 579 1192

IS220

Issue 7 07.10.22