

# MAXWATT

POWER WHEN YOU NEED IT

## Generator Operator's Manual





## TABLE OF CONTENTS

---

CHAPTER	PAGE
1. About Your Generator.....	3
2. Specifications.....	6
3. General Safety Rules.....	7-11
4. Component Identification.....	12
5. Assembly Instructions.....	16
6. Generator Set Up.....	17-23
7. Starting the Engine.....	24-30
8. Stopping the Generator.....	30
9. 2 Wire Auto Start.....	31-32
10. Storage.....	33-34
11. Maintenance and Repair.....	35-38
12. Trouble Shooting.....	39
13. Label Identification.....	41
14. Warranty Information.....	42-46

## **ABOUT YOUR GENERATOR**

Thank you for purchasing a MAXWATT generator (hereinafter referred to as the generator).

This generator is suitable for use on various trade worksites, recreational such as camping and for use as backup power whether residential or commercial.

Please read and understand this manual for instructions on start-up, shut down, operations, adjustments, maintenance as well as safety guidelines before using this product. Please take all possible precautions to protect your own safety and that of the people in the immediate vicinity. This manual is the latest version. Save this manual for future reference.

As this product is continuously improved and upgraded, the manufacturer reserves the right to modify this manual without notice.





The manufacturer shall not assume any liability for incorrect information contained in this manual.

This manual is an essential and important tool for the use of the generator. When the generator is transferred to new owners, the manual must be given to the new owners as well.

Some important information in this manual will be indicated in the following way. The owner/user must pay special attention to these instructions.

MAXWATT is constantly improving its products. All information supplied in this manual is based on the latest product information available at the time of printing. The specifications outlined herein are subject to change without notice or obligation. The purchaser and/or user shall assume liability for any modification and/or alterations of this equipment from original design or manufacture.

## HAZARD SIGNAL WORD DEFINITIONS

	Indicates an imminently hazardous situation which, if not avoided, will result in death or serious injury. Obey all safety messages that follow this symbol to avoid possible injury or death.
 <b>DANGER</b>	Indicates an imminently hazardous situation which, if not avoided, will result in death or serious injury.
 <b>WARNING</b>	Indicates a potentially hazardous situation which, if not avoided, could result in death or serious injury.
 <b>CAUTION</b>	Indicates a potentially hazardous situation which, if not avoided, may result in minor or moderate injury.
<b>CAUTION</b>	Used without the safety alert symbol indicates a potentially hazardous situation which, if not avoided, may result in property damage.

The range of MAXWATT generators is safe and reliable, but incorrect usage of these products may cause personal injury and damage to the machine.

In order to operate safely strictly adhere to the operator’s manual, please read it through carefully before using the generator.

## BEFORE STARTING

### UNPACKING AND DELIVERY INSPECTION

You should inspect the generator immediately after you receive delivery thereof. If you have any missing parts, please contact your place of purchase. DO NOT attempt to operate the generator if there are any missing parts.

The generator is shipped without oil. You must add an adequate amount of engine oil before using it for the first time. The engine will be damaged beyond repair if it is started without oil. For oil type, please see “Recommended Oil Type” section of this manual on page 9. Fresh regular RON 91 fuel must be used in this unit. DO NOT use Premium or Ethanol based fuels.

### SAFETY SIGNS

Comply with the instructions provided by the safety signs and symbols fitted to the generator and in this manual. The generator and manual only feature the symbols relevant to the model purchased. Check that the symbols and signs affixed to the unit are always present and legible, otherwise fit replacements in the original positions.

## **GENERAL WARNINGS & DISCLAIMER**

READ and UNDERSTAND this manual completely before using the engine. Failure to properly set up, operate and maintain this engine could result in serious injury or death from carbon monoxide poisoning, electric shock, fire/explosions or burns. In particular be aware of the following hazards:

### **CD Poisoning:**

Engines give off carbon monoxide, an odourless, colourless poisonous gas that can kill you. You CANNOT smell it, see it or taste it. ONLY run an engine OUTDOORS and AWAY from building air intakes. NEVER run an engine inside any enclosed or semi-enclosed spaces, including homes, basements, garages, sheds, boxes, RV's, boats or pick-up truck beds. These spaces can trap poisonous gases, EVEN if you run a fan or open windows.

### **Electric Shock / Electrocutation:**

High voltage electricity from the generator can kill. DO NOT operate in wet locations or conditions. Be sure the generator is properly grounded. Use only outdoor rated grounded extension cords of proper size.

NEVER plug the generator directly into a wall plug outlet. ANY connection to a building's electrical system MUST ISOLATE THE GENERATOR FROM UTILITY POWER via a transfer switch installed by a licensed electrician. Otherwise, back-feed from the generator into the power grid could kill utility workers. See "Set up as a building back-up" on page 13 for additional information.

BEFORE performing any maintenance on the generator, disconnect the engine starting battery (if equipped) to prevent accidental start-up. Disconnect the cable from the battery post indicated by a NEGATIVE, NEG or (-) first. Reconnect the cable last.

### **Heat:**

Unintentional spark can result in fire or electric shock.

### **Fire / Explosion:**

DO NOT overload the engine (per rate capacity) and OPERATE ONLY in an area with adequate cooling ventilation so engine does not overheat. The exhaust can be extremely hot. Keep the muffler at least 3 metres from all combustible objects.

All fuels are flammable. Never fuel a running or hot engine. Never pump fuel directly into the engine at a petrol station – use an approved container to transfer the fuel. Ensure that there are no fuel leaks and keep sources of sparks and flames away. Wait for the engine to be cool before fuelling. ALWAYS keep a fire extinguisher rated "ABC" nearby.

### **STOP!**

CHOOSE THE RIGHT GENERATOR FOR YOUR NEEDS. See the Power Load Planning and Management section on page 18 to determine your power load requirements and then compare to the generator's rate capacity.

INSPECT COMPONENTS: Closely inspect to make sure that there are not any components missing or damaged. ARRANGE FOR PROFESSIONAL INSTALLATION of a transfer switch if you will be connecting the generator to your building's system.

## SPECIFICATIONS

Model	MX3000R	MX7000R	MX7000ES	MX9000ES/AS
Frequency	50Hz	50Hz	50Hz	50Hz
Rated power	2.5KW	5.0KW	5.0KW	7.0KW
Max. power	2.8KW	5.5KW	5.5KW	7.5KW
AC Voltage	240V	240V	240V	240V
Phase	Single	Single	Single	Single
Fuel capacity	15L	40L	40L	40L
Oil capacity	0.6L	1.1L	1.1L	1.1L
Run time@50% load	9H	17.5H	17.5H	16H
Run time@100% load	6.5H	14H	14H	11H
Engine model	AP170	SC390	SC390	SC460
Displacement	208cc	389cc	389cc	459cc
Max. output	6.5HP/3000rpm	13HP/3000rpm	13HP/3000rpm	16HP/3600rpm
Start system	Recoil	Recoil	Recoil/E-START	Recoil/E-START
Dimension	595x465x535	710x695x685	710x695x685	710x695x685
Net Weight	48	90	87	96

## GENERAL SAFETY RULES FOR OPERATION



Read all safety warnings, instructions, illustrations and specifications provided with this generator. Failure to follow all instructions listed below may result in electric shock, fire and/or serious injury.

Save all warnings and instructions for future reference.

This equipment is to be used for the purpose for which it is designed and intended. Seek assistance if required when moving or lifting the generator.

### WORK AREA SAFETY

- **Intended for outdoor use only.** DO NOT operate in confined spaces or indoors as carbon monoxide released in the exhaust can kill.
- **DO NOT operate in explosive atmospheres such as in the presence of flammable liquids, gases or dust.**
- **Keep children and bystanders away while operating a generator.** Distractions can cause you to lose control.
- **Keep your work area clean and well lit.** Cluttered benches and dark areas invite accidents.
- **This generator is not weatherproof.** Exposure to rain, damp conditions or extreme temperatures can cause damage or serious injury.

### PERSONAL SAFETY

- **Stay alert, watch what you are doing and use common sense when operating a generator. DO NOT use a generator while you are tired or under the influence of drugs, alcohol or medication.** A moment of inattention may result in serious personal injury.
- **Use personal protection equipment.** Always wear eye protection. Wear approved safety impact eye goggles, dust mask, non-skid safety shoes, hard hat and hearing protection for appropriate conditions.
- **DO NOT overreach.** Keep proper footing and balance at all times. This enables better control of the generator in unexpected situations.
- **Dress properly.** DO NOT wear loose clothing, gloves, neckties or jewellery. Keep your hair and clothing away from moving parts. Loose clothes, jewellery or long hair can be caught in moving parts.
- **DO NOT let familiarity gained from frequent use of the generator allow you to become complacent and ignore safety principles and rules.** A careless action can cause severe injury within a fraction of a second.
- For your own safety, do not operate your generator until it is completely assembled and installed according to the instructions and until you have read and understood all of the instructions.



## GENERATOR SAFETY RULES

- **DO NOT force the generator. Use the correct generator for your application.** The correct generator will do the job better and safer at the rate for which it was designed.
- **DO NOT use the generator if the engine switch does not turn it on and off.** Any generator that cannot be controlled with the switch is dangerous and must be repaired.
- **Know properly how to stop the generator.** Be thoroughly familiar with proper use of the equipment and all engine controls, output receptacles and connections. Know how to stop the engine quickly (see “Stopping the Generator”).
- **Instruct operators.** The engine owner must instruct all operators in safe engine set-up and operation. Only trained adults should set up and operate the engine. DO NOT let children operate it.
- **Intended use.** Carefully read about and understand the intended use of this engine. DO NOT use for other purposes as unforeseen hazards or equipment damage may result.
- **Under the influence.** NEVER operate or let anyone else operate the engine while under the influence of alcohol, drugs or medication.
- **Safety equipment / controls.** DO NOT operate the engine unless all safety covers, guards and barriers are in place and in good working order – and that all controls are properly adjusted for safe operation.
- **Damaged.** DO NOT operate the generator with damaged, missing or broken parts.
- **Modifications.** DO NOT modify the generator in any way. Modifications can create hazards and will also void the warranty.
- **Generator speed.** NEVER attempt to modify the generator speed setting. The generator speed is present for safe and optimal performance of the generator. If speed needs adjusting, it must be done by factory personnel.
- **External fuel sources.** NEVER attempt to connect external fuel sources in order to increase generator run time. A larger tank at pressure or higher elevation will cause a leak from the carburettor during operation. A fire or an explosion could result.
- **Adjusting / repairing.** Always turn off the generator and remove the spark plug(s) or spark plug wire(s) before working on the generator to prevent accidental starting. Always discharge the capacitor before working on the generator head to prevent electrical shock. (See Maintenance & Repair section of this manual for instructions on how to do this.)
- **Carbon monoxide poisoning.** The running generator gives off carbon monoxide, a poisonous gas that can kill you. You CANNOT smell it, see it, or taste it. Follow all instructions for site selection and positioning the generator and avoid inhaling the exhaust. If you start to feel sick, dizzy or weak while using the generator, shut off the generator and get to fresh air RIGHT AWAY. See a doctor. You may have carbon monoxide poisoning.

- **Malfunction during operation.** Immediately turn off the generator if any of the following conditions arise during operation:
  1. Excessive change in generator speed, slow or fast;
  2. Sparking or arcs from generator;
  3. Loss of electrical output;
  4. Receptacle damage;
  5. Generator misfire;
  6. Excessive vibration;
  7. Flame or smoke or
  8. Abnormal noise
    - **Other exhaust dangers.** This product contains or emits chemical known to the Commonwealth of Australia to cause cancer, birth defects or other reproductive harm. Avoid inhalation of exhaust.
    - **Wet Conditions.** DO NOT operate the engine or handle any electrical equipment while standing in water, while barefoot, while hands are wet or while in the rain or snow. An electric shock may result.
    - **Avoid contact.** Avoid contact with bare wires, terminals, connections, etc. while the unit is running.
    - **Electric shock accident.** If an electric shock accident occurs, immediately shut down the source of electrical power. If this is not possible, attempt to free the victim from the live conductor. Avoid direct contact with the victim. Use a non-conducting implement, such as a dry rope or board, to free the victim from the live conductor. Apply first aid and get immediate medical help.
    - **Smoking/sparks.** Never smoke near the running engine and never operate near sources of sparks or flames.

## SERVICE

- **Have your generator serviced by a qualified repair person using only factory approved replacement parts.** This will ensure that the safety of the generator is maintained. Incorrectly fitted parts will void your warranty.
- **The equipment may only be used, maintained or repaired by those persons who understand and have been instructed about the potential dangers.** Independent changes in the equipment cancel any manufacturer's liability for any damages that result from these changes.

## APPROPRIATE USE

- Use the equipment only when it is in technically perfect condition and only for appropriate jobs, with an awareness of safety and possible dangers, based on observation of the operating instructions. In particular, problems which could influence the operational safety must be dealt with immediately.
- All of the manufacture's safety, work and maintenance regulations as well as the given norms in the Technical Data must be observed.

## **STATIC ELECTRICITY AND FILLING THE PETROL TANK**

Static electricity can initiate from un-grounded petrol tanks or containers, from flowing petrol and persons carrying a static electric charge. Static electricity can explosively ignite petrol vapours that are present during the fuelling process resulting in serious burns to nearby persons.

Many objects can accumulate and retain a static electric charge. Objects made of non-conductive materials (eg. Plastics) easily accumulate and retain static electric charge, as can objects made of conductive material (eg. Metal, water) if they are not electrically grounded.

To avoid static electricity while fuelling, certain steps must be followed before and during the fuelling process in order to minimise and safely dissipate static charge build-up:

- Touch a grounded metal object before starting. Always dissipate static charge from your body before beginning the fuelling process by touching a grounded metal object at a safe distance away from the fuel source.
- Use a portable container to fill the tank. NEVER fill the engine's petrol tank directly from the fuel pump – the engine's tank is not grounded and the high velocity flow of petrol from a fuel pump can cause static electric build-up. Use an approved portable container to transfer to the engine's tank.

## **TYPICAL SOURCES OF STATIC ELECTRIC HAZARDS DURING FUELLING**

The following objects can accumulate a static electric charge and cause an ignition spark in typical fuelling situations:

- Ungrounded tanks/containers. Any ungrounded fuel tank or container can accumulate a static electric charge as a result of contact with other objects or friction during transportation. This static electricity can discharge as a spark to the grounded petrol dispenser nozzle as the nozzle is first brought close to the tank/container at the beginning of the fuelling process.
- Flowing petrol. Most people are not aware that petrol accumulates static electric charge while flowing through a hose or pipe. This charge then transfers to and accumulates in the gas tank or container that is being filled. The total amount of charge accumulation depends on the amount of gas pumped into the container, the speed with which it is pumped, and whether or not the tank/container is grounded. If sufficient static electric charge accumulates in the fuel tank or container during the fuelling process, the tank/container may discharge a spark to the grounded petrol dispenser nozzle.
- Persons. A person dispensing the petrol can carry a static electric charge on their body, typically resulting from contact with their car seat or electronics. The static electricity can discharge a spark between that person's hand and either the grounded dispenser nozzle or the fuel tank opening.

# RECOMMENDED OIL TYPE

Climate determines proper engine oil viscosity. Select oil type based on temperature indicated from below charge (source: Society of Automotive Engineers).

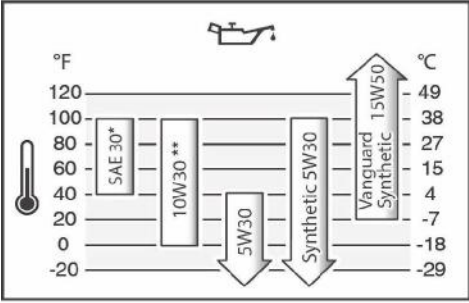

# COMPONENT IDENTIFICATION

Control Panel. See next page for panel identification designed for your generator.

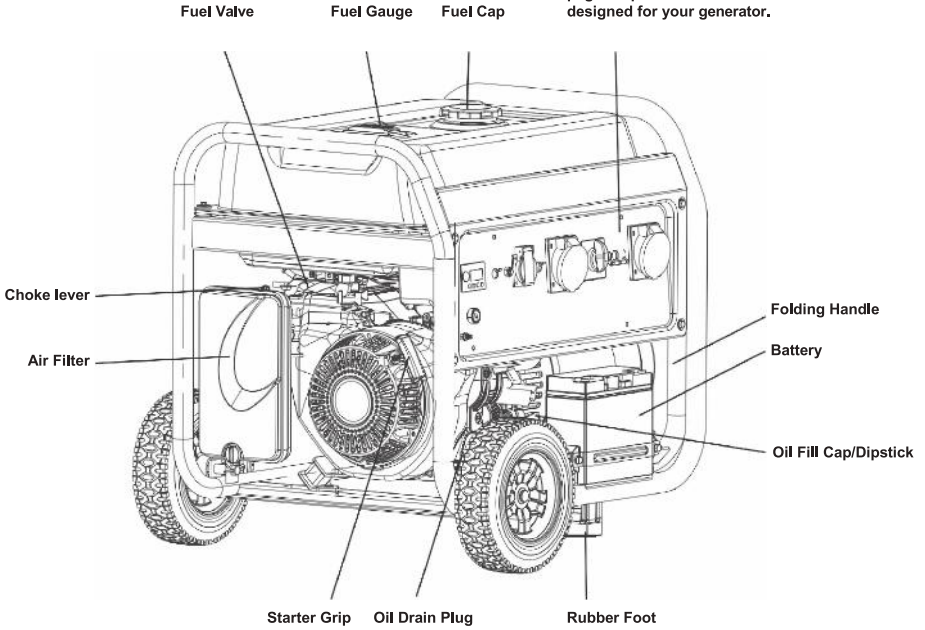

## CONTROL PANEL IDENTIFICATION

MODEL:MX3000R



MODEL: MX7000R

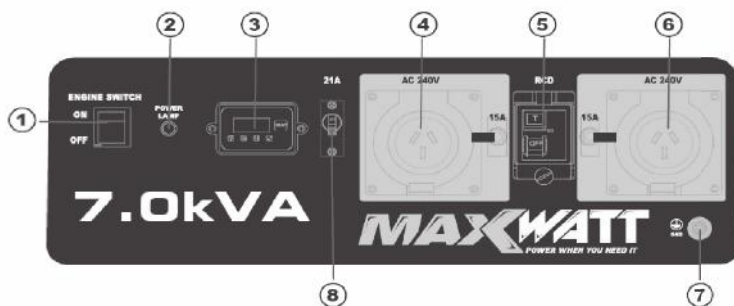

1. ENGINE SW.
2. POWER LAMP
3. POWER LAMP
4. AC OUT PUT

5. RCD
6. AC OUT PUT
7. Ground Terminal
8. CIRCUIT BREAKER

MODEL:MX7000ES

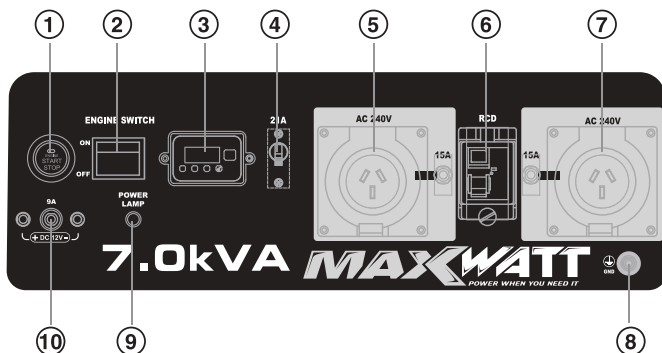

MODEL:MX9000ES

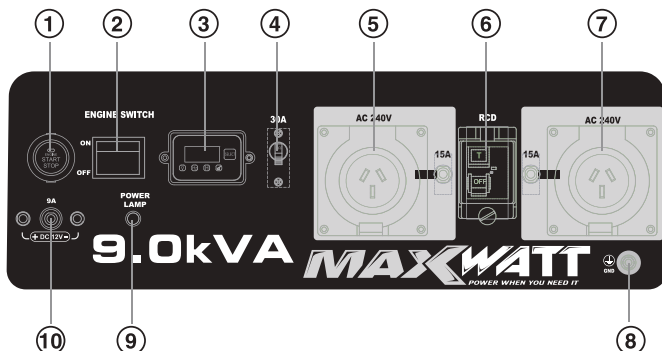

1. ENGINE START
2. ENGINE SWITCH
3. DIGITAL DISPLAY
4. CIRCUIT BREAKER
5. AC OUT PUT

6. RCD
7. AC OUT PUT
8. GROUND TERMINAL
9. POWER LAMP
10. DC OUT PUT

# MODEL:MX9000AS

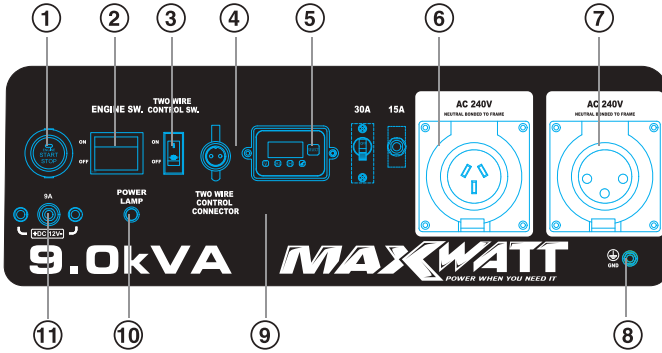

- 1. ENGINE START
- 2. ENGINE SWITCH
- 3. TWO WIRE CONTROL SWITCH
- 4. DIGITAL DISPLAY
- 5. CIRCUIT BREAKER
- 6. AC OUT PUT
- 7. AC OUT PUT
- 8. GROUND TERMINAL
- 9. TWO WIRE CONTROL CONNECTOR
- 10. POWER LAMP
- 11. DC OUT PUT

## ENGINE KEY START IGNITION SWITCH LOW OIL INDICATOR

Engine start and on/off switch control.

## DC BREAKER

Protects the generator against overload or short circuit of the 12-Volt DC system. If the circuit breaker trips, turn off and unplug all appliances from the generator and let the overload cut-out switch cool. Then press DC reset button before commencing to use the DC outlet.

## 12V OUTLET

Can be used for 12V DC powered devices. Maximum output 8.3 amps.

## RCBO SAFETY SWITCH

RCBO is a switch that combines RCD and MCB which automatically turns off in the event of electrical overload. This switch can also be used to turn off power supply to each AC outlet.

The low oil level indicator light illuminates when the oil level is too low. If the engine runs low on oil during operation, the engine will stop operating within 10 seconds.

## DIGITAL METER

This digital display shows Voltage, Frequency and Run Time (by hours).

## THERMAL PROTECTOR

Thermal overload protection device. Push to reset.

## 240V 15A AC OUTLETS-IP66

Each outlet is capable of delivering the generator's full output or 15 AMPS (3600 watts), whichever is the lesser.

## GROUND TERMINAL

The frame terminal can be used by a licensed electrician to earth the generator if necessary.



# ASSEMBLY

## Remove shipping bracket (Fig 1)

Remove and discard the RED shipping bracket and mounting hardware before starting the generator

## Attaching wheels (Fig 2)

1. Parts needed – 2 wheels, 2 axles, 2 locking pins, 4 washers, 2 hub caps and 2 self- tapping screws.
2. Raise or tilt the generator so that you can slide the wheel axle pin into the wheel, the washer the wheel mounting hole is located on the side of the frame.
3. Secure the wheel assembly by reinserting the pin through the hole at the end of the wheel axle and pressing it until it locks in place.
4. Install the hub cap on the wheel until it clicks in, then install the self-tapping screw.
5. Repeat the process to the alternate wheel.

## Installing supporting feet (Fig 3)

1. Parts needed – 2 Rubber feet and 2 MB screws.
2. Raise the front end of the generator high enough to gain access to the bottom of the frame.
3. Securely position props as support.
4. Line up the holes on the support leg bracket to the holes on the front of the generator frame.
5. Attach the support legs using M\* screws

## Attaching the Battery

1. Parts needed – black and red battery cable.
2. First, connect the red cable to the positive (+) battery terminal first.
3. Remove the screw from the battery terminal.
4. Place the screw through the eyelet and tighten the screw and make sure the terminal will not touch any part of the frame.
5. Install the red protection boot.
6. Repeat these steps for the black (-) terminal.

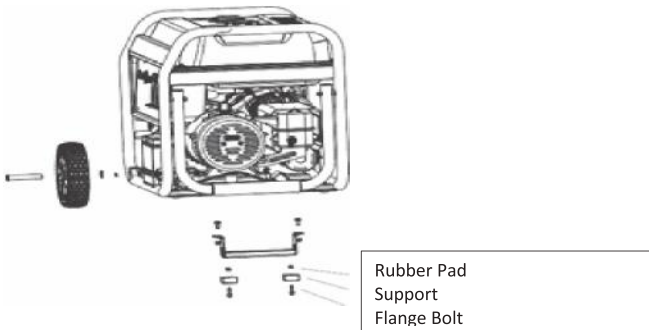

# GENERATOR SET UP

## PLANNING THE POWER LOAD

Plan your power load so that you do not exceed the generator's rate capacity. To calculate the running and start wattage requirements for the devices you will be powering, follow the steps on page 16.

## SET UP THE PORTABLE POWER SOURCE

This generator is designed to provide up to its max power (in watts) of electrical power. When using the generator as a portable power source, you can plug electric devices and appliances directly into the generator's electrical outlets. This generator is equipped with 3 SAA approved IP66 rate socket outlets.

Make sure you plug each electrical device/appliance into the correct generator outlet based on the device's plug configuration and voltage/amperage rating. NEVER exceed the amperage rating of an outlet. Note: You must NOT overload the generator. Overloading may cause serious damage to the generator and attached electrical devices.

## SET UP AS BUILDING BACK UP

To set up as a building backup, you must arrange for a licensed electrician to connect the generator to your building's electrical system via the installation of an approved transfer switch. The transfer switch must be installed in accordance with the building electrical code and guidelines supplied by your power company.

A transfer switch does the following:

- Safely connects the generator to your building's electrical system by isolating your generator from your utility company's power lines.
- Connects your generator to a critical subset of your building's circuits that are needed for emergency power needs.

 <b>DANGER</b>	<p>A transfer switch must be installed in order to isolate your generator from the utility power grid. If your generator is NOT properly isolated from the utility system, serious hazards will arise.</p> <p>When your generator is running, its output will back feed into the utility power line and transformer that are normally used to provide you with power. The transformer will step up the current to the normal line voltage. An unsuspecting utility line worker working on what he thinks is a deactivated line could be electrocuted.</p> <p>If your generator is connected (running or not) when utility power is restored, your generator will be destroyed. It could also explode or cause fire.</p>
---	---

**Note:**

Regardless of whether you use your generator as a back-up power source connected to a building or as a portable power source, you **MUST NOT** overload the generator. Overloading may cause serious damage to the generator and attached electrical devices.

If your generator will be connected to your building's system, it **MUST ALWAYS BE** isolated from the utility power grid with an approved transfer switch installed by a licensed electrician in

compliance with all applicable building and electrical codes and in accordance with the guidelines supplied by your power company.

There may be Federal or State Occupational Safety and Health Administration (OSHA) regulations, local codes or ordinances that apply to the intended use of the generator. Please consult a qualified electrician, electrical inspection or the local agency having jurisdiction.

- In some areas, generators are required to be registered with local utility companies.
- If the generator is used at a construction site, there may be additional requirements that must be observed.

## GROUNDING THE GENERATOR

 <b>WARNING</b>	In order to avoid electrical accidents, all connections to the distribution panel must be carried out by qualified technicians. Incorrect connections can harm people and damage the generator.  Operating the generator when it's not properly grounded can result in electrical shock.
--	--

Standard generators are protected by electrical separators. This equipment has a thermic protection device and/or magnet-to-thermic device to protect against a surge of current, overloading and short-circuiting. In these cases, the generator should under NO circumstance, be earthed using the terminal “PE” or with any other part of the generator.

If a licenced electrician installs the generator with a connection to your building’s electrical circuit for use as a back-up power system, grounding may alternatively be completed through the building’s grounding system. Ask your electrician.

 <b>WARNING</b>	Grounding is not required when the generator is used as a portable power source. Below grounding method is only needed by a qualified electrician if not connecting through your building’s electrical system.
--	--

If the generator is not grounded through your building’s system, follow the procedure below. This procedure can only be carried out by a licenced electrician.

1. Drive a ¾” or 1” copper pipe or rod into the ground close to the generator. The pipe/rod must penetrate moist earth – the depth required will be dictated by local soil conditions.
2. Connect an approved ground clamp to the pipe.
3. Run a 10-gauge wire from the clamp to the generator grounding post located on the rear of the generator head.
4. Do not connect the generator grounding post to a water pipe or a ground used by the radio system.

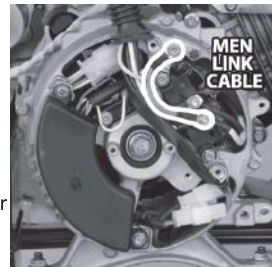
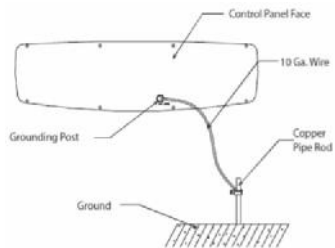

**IMPORTANT: (except model MX9000AS and MX3000R which has no RCD and MEN link.)**  
This generator is fitted with a MEN link(yellow-green cable) cable, the neutral is internally bonded to the generator earth. When a licenced electrician is installing the generator to a building to be used

as a backup power source, the MEN must be removed. The MEN link is located underneath the alternator end cap which is labelled to indicate its location. The MEN link cable is clearly labelled as “MEN link.”

## EXTENSION CORDS

Extension cords may be used to power devices that are located at a distance from the generator. However, use only Australian approved outdoor-rated, grounded extension cords. Locate the generator in a convenient place and where possible, avoid long extension leads and possible damage to leads by pedestrian or vehicular traffic.

Extension leads should be heavy duty with at least 1mm of appropriate current rating and in any case, not less than 1mm cross-section of conductor and must incorporate an earthing conductor to ensure that there is no voltage difference between the generator set and any equipment powered by the generator.

The electrical continuity of the “earthing” core should be checked periodically from pin to socket to ensure continued electrical safety. Some electrical appliances, eg. portable drills, are marked “double insulated”, in which case there should not be an earthing conductor in its mains lead (even though it may have a three-pin plug).

	<p>Use of under sized extension cords can cause electric shock, fire, or damage to connected devices. All extensions and appliance cords must be in good working condition and not worn, bare, frayed, or otherwise damaged.</p> <p>Use of damaged electric cords can cause electric shock or fire. Note: If an extension cord becomes hot to the touch, it is overloaded or damaged and must be replaced. Maxwatt is NOT responsible for damage or injury resulting from customer use of inadequate extension cords.</p>
---	---

## SELECT A SUITABLE SITE

Before using the generator, you must select a suitable OUTDOOR location for installation and operation that meets the following criteria:

### DRY, LEVEL SURFACE:

The generator should be positioned on a dry, firm and level surface. Ensure that the generator sits level and will not slide or shift during operation. If applicable, block the generator’s wheels to prevent sliding and shifting.

	<p>You must choose a suitable site for operating your generator to avoid equipment damage and/or injury and possible death from carbon monoxide poisoning, electric shock, or fire.</p>
---	---

## OUTDOORS ONLY:

Follow the directions below for choosing a location to operate your generator in order to avoid carbon monoxide poisoning:

- The location you choose to operate the generator must be OUTDOORS and away from all building air intakes.
- Never run the generator inside any close or semi-enclosed spaces (even if outdoors), including homes, garages, basements, sheds or boxes. These spaces can trap poisonous gases, even if you run a fan or open windows.
- Ensure that working, battery-operated or battery back-up carbon monoxide alarms are used in any dwelling/structure that is in close proximity to the running operator.

Note that this generator is NOT designed or approved for use in vehicles or marine applications. Never run the generator inside RVs or other vehicles such as boats or on pick-up truck beds.

 <b>WARNING</b>	<p>The exhaust from your generator contains carbon monoxide (CO), a poisonous gas that can kill. You cannot smell it, see it, or taste it. Breathing carbon monoxide can cause loss of consciousness and may lead to death. Never run your generator in a coned or even partially enclosed areas or near open windows or doors.</p> <p>Never attempt to attach ductwork to the muffler system to allow for installation inside an enclosure. This could cause hot air, heat build-up and increased exhaust back-pressure, resulting in possible exhaust leakage or damage to the generator.</p>
--	---

## ADEQUATE COOLING VENTILATION

- The generator needs adequate, unobstructed flow of air to allow for proper cooling of the engine and generator head.
- Never place the generator immediately adjacent to a building or other structure – allow at least 2 metres clearance.
- Do not run the generator in close proximity to other heat-generating equipment, such as another generator. The combined heat that is generated may raise air temperature in the immediate area and there will not be adequate cooling ventilation.
- Do not allow debris to accumulate and block airflow.
- Do not operate with a tarp, blanket, or cover surrounding the generator.

 <b>WARNING</b>	<p>Heat build-up from inadequate ventilation can result in fire, posing a serious risk to nearby persons and structures. Situate so there is adequate clearance around generator to allow for cooling airflow so that heat does not build up.</p>
--	---

## HOT EXHAUST CLEARANCE

- Make sure your generator's exhaust system is at least 2 meters from all combustible materials and buildings/structures.
- Equip the engine with a spark arrestor if the generator will be used near any ignitable forest, brush, or grassy land. (see the "Specifications" section of this manual to determine

if your generator is already equipped). Make sure you comply with applicable local, state and federal codes.

- Keep a fire extinguisher rated “ABC” nearby. Keep it properly charged and be familiar with its use.

## **NO WET CONDITIONS**

Choose a location where the generator will NOT be exposed to rain, snow or direct sunlight. Exposure to water can cause electric shock. You may operate the generator under an outdoor canopy-like structure of heat-resistant material that is open on all sides. Make sure that all parts of the canopy are at least 2m from the exhaust and allow for adequate clearance above the generator so that heat does not build up.

## **OPERATE AWAY FROM DUST/DIRT**

Do not use the generator in extremely dusty or dirty conditions. Excessive dust and dirt can cause premature failure of the machine.

## **HEARING PROTECTION**

Generators can product noise levels >70dB in close proximity, which can be dangerous to human hearing with prolonged exposure to the running generator for an extended period of time.



Never attempt to attach ductwork to the muffler system to lower noise levels. This could cause hot air deflection, heat build-up and increased exhaust back-pressure, resulting in possible exhaust leakage or damage to the generator.

## **An Important Message about Temperatures**

Your generator is designed and rated for continuous operation at ambient temperatures up to 40 degrees Celsius. When your generator is needed, it may be operated at temperatures ranging from -15 degrees Celsius to 50 degrees Celsius for short periods. If the generator is exposed to temperatures outside this range during storage, it should be brought back within this range before operation. In any event, the generator must always be operated outdoors, in a well-ventilated area and away from doors, windows and other vents.

When operated above 25 degrees Celsius, there may be a decrease in power. Maximum wattage and current are subject to and limited by such factors as fuel BTU content, ambient temperatures, altitude, engine condition etc. Maximum power decreases about 3.5% for each 1000 feet above sea level, and will also decrease about 1% for each -12.2 degrees Celsius above 16 degrees Celsius ambient temperature.

## POWER LOADING MANAGEMENT



**WARNING**

NEVER exceed the rated wattage capacity of your generator. OVERLOADING may cause SERIOUS DAMAGE to the generator and attached electrical devices and may result in fire.

Your generator **MUST BE SIZED PROPERLY** to provide both the running and starting (surge) wattage of the devices you will be powering. Before using your generator, determine the running and starting wattage requirements of all the electrical devices you will be powering simultaneously. Following below are 4 simple steps and an example on the right:

- Step 1 Determine the tools and appliances you want to power at the same time.
- Step 2 List the start up and running power usage (watts) for each product.
- Step 3 Add the total power usage and add 10% as a safety net.
- Step 4 Choose a generator with a rated maximum power than equals or exceeds your totals. In this case, a generator with a rated power of at least 3108W and a maximum power output greater than 7233W would be required.

PRODUCT	RUNNING	START UP
1HP Water Pump	750W	4500W
Lights	75W	75W
Table saw	2000W	2000W
<b>Total</b>	<b>2825W</b>	<b>6575W</b>
+10%	<b>3108W</b>	<b>7233W</b>

### STARTING POWER CONSUMPTION:

Electronic appliances and brushed motors generally will not draw more than running watts at start up. Induction motors in equipment like air conditioners, welders, water pumps and compressors can draw 2 to 5 times their running power to start. Please consult your equipment's rating label, manual or the manufacturer to confirm specific requirements. If only the running wattage is given on the nameplate for a device with an electric motor, the starting wattage can be approximated to be three to five times the running wattage. Estimates for the running wattage requirements for common devices are listed below. Guidance for starting wattages is provided in the table's footnotes.

To size your generator correctly, you need to use watts – here are some useful calculations:  
Watts = Volts x Amps. Example: 240 Volts x 5 Amps = 1200 watts.

DEVICE	RUNNING WATTS	DEVICE	RUNNING WATTS
Air conditioner (12,000 BTU)	1700 (a,b)	Jet pump	800 (a)
Battery charger (20 Amp)	500	Lawn mower	1200
Belt sander (3")	1000	Light bulb (100 Watt)	100
Chain saw	1200	Microwave oven	700
Circular saw(6½")	2000 (a,b)	Milk cooler	1100 (a)
Coffee maker	1800 (a,b)	Oil burner on furnace	300
Compressor (1 HP)	1400 (a,b)	Oil-red space heater (140,000 Btu)	400
Compressor (3/4 HP)	1800 (a)	Oil-red space heater (85,000 Btu)	225
Compressor (1/2 HP)	1400 (a)	Oil-red space heater (30,000 Btu)	150
Curling iron	700	Oven	4500
Dishwasher	1200	Paint sprayer, Airless (1/3 HP)	600 (a)
Edge trimmer	500	Paint sprayer, Airless (handheld)	150
Electric nail gun	1200	Radio	200
Electric range (1 element)	1500	Refrigerator	600 (b)
Electric skillet	1250	Slow cooker	200
Furnace fan (1/3 HP)	1200 (a)	Submersible pump (1-1/2 HP)	2800 (a)
Freezer	800 (b)	Submersible pump (1 HP)	2000 (a)
Hair dryer	1200	Submersible pump (1/2 HP)	1500 (a)
Hand drill (1")	1100	Sump pump	600 (a)
Hand drill (3/8")	500	Television	500
Hedge trimmer	450	Toaster	1000
Home computer	150	Vacuum cleaner	250
Kettle	2400	Water heater	3000



## STARTING THE ENGINE

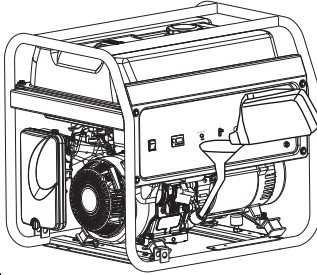

### ADD ENGINE OIL:

1. Check that all shields and covers are in place and all nuts, bolts and screws are tightened.
2. Place the generator on a level surface.
3. Fill the engine with 1.1 L of qualified engine oil.
4. Check the engine oil level. Add oil if low. Do not overfill. Running the engine without sufficient oil can cause irreparable damage.



Fill oil to the bottom lip of the dipstick

### ADD PETROL:

 <b>WARNING</b>	
	<b>Petrol and its vapors are extremely flammable and explosive.</b>
	<b>Fire or explosion can cause severe burns or death.</b>
<b>WHEN ADDING PETROL</b>	
<ul style="list-style-type: none"><li>• Turn generator OFF and let it cool at least 2 minutes before removing petrol cap. Loosen cap slowly to relieve pressure in tank.</li><li>• Fill petrol tank outdoors.</li><li>• DO NOT overfill tank. Allow space for petrol expansion.</li><li>• Keep petrol away from sparks, open flames, pilot lights, heat, and other ignition sources.</li><li>• DO NOT light a cigarette or smoke.</li></ul>	

1. Check fuel level. Add fuel (Fresh unleaded RON91) is recommended. Please note that the engine is certified to operate of unleaded fuel only. Starting with a full tank will help to eliminate or reduce operating interruptions for refuelling. Check fuel system components and lines for signs of leak. DO NOT use petrol which contains Methanol. DO NOT mix oil with petrol.
2. Clean area around petrol fill cap, remove cap.
3. Add regular unleaded petrol to petrol tank. Be careful not to overfill. Allow about 4cm (1.5") of tank space for petrol expansion (Figure 1).

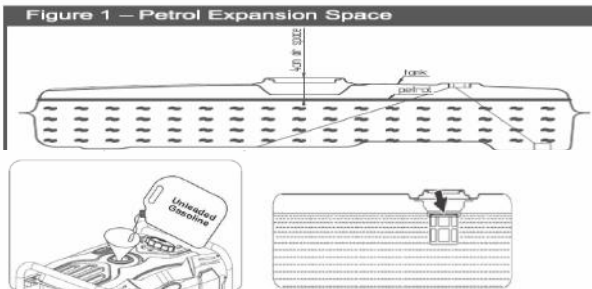



## RCBO SAFETY CHECK(EXCLUDING MX9000AS)



1. Lift the clear plastic cover on the panel to access the RCBO safety goggle switch.
2. TEST THE RCBO before each and every use by pressing the test button. This will immediately cause the unit to trip and shut off the power to the socket outlets. If the RCBO fails to switch OFF after depressing the test button (marked “Y”), then the unit should be immediately taken out of service, tagged appropriately and NOT be used until repaired by a qualified electrician.
3. RESET THE RCBO by simply switching the RCBO toggle to ON position.
4. The unit is now ready for operation. No electrical device should be operated or plugged in prior to checking for physical damage and testing of the RCBO.

## USING THE GENERATOR:

1. The generator has a system ground that connects the generator frame components to the ground terminals on the AC output receptacles.
2. Please consult a qualified electrician for any installation.
3. If the generator is used at a construction site, there are additional regulations which must be followed.
4. Connections for standby power to a building's electrical system must be made by a qualified electrician. The connection must isolate the generator power from utility power, and must comply with all applicable laws and electrical codes.

 <b>WARNING</b>	
	<p><b>Generator produces powerful voltage. Failure to isolate generator from power utility can result in death or injury to electric utility workers due to backfeed of electrical energy.</b></p>
<ul style="list-style-type: none"><li>• When using generator for backup power, notify utility company. Use approved transfer equipment to isolate generator from electric utility.</li><li>• Use a ground fault circuit interrupter (GFCI) in any damp or highly conductive area, such as metal decking or steel work.</li><li>• DO NOT touch bare wires or receptacles.</li><li>• DO NOT use generator with electrical cords which are worn, frayed, bare or otherwise damaged.</li><li>• DO NOT operate generator in the rain.</li><li>• DO NOT handle generator or electrical cords while standing in water, while barefoot, or while hands or feet are wet.</li><li>• DO NOT allow unqualified persons or children to operate or service generator.</li></ul>	

## GENERATOR LOCATION

 <b>WARNING</b>	
	<b>Running generator gives off carbon monoxide, an odorless, colorless, poison gas. Breathing carbon monoxide will cause nausea, fainting or death.</b>
<ul style="list-style-type: none"><li>• Operate generator <b>ONLY</b> outdoors.</li><li>• Keep exhaust gas from entering a confined area through windows, doors, ventilation intakes or other openings.</li><li>• <b>DO NOT</b> operate generator inside any building or enclosure, including the generator compartment of a recreational vehicle (RV).</li></ul>	

1. The generator must be at least 3m from structures having combustable walls and/or other combustable materials. Leave at least 1m all around generator including overhead, for adequate cooling, maintenance and servicing.
2. Place generator in a well-ventilated area, which will allow for removal deadly exhaust gas.
3. **DO NOT** place generator where exhaust gas could accumulate and enter inside or be drawn into a potentially occupied building. Ensure exhaust gas is kept away from any windows, doors, ventilation intakes or other openings that can allow exhaust gas to collect in a confined area (Figure 2).
4. Prevailing winds and air currents should be taken into consideration when positioning generator.

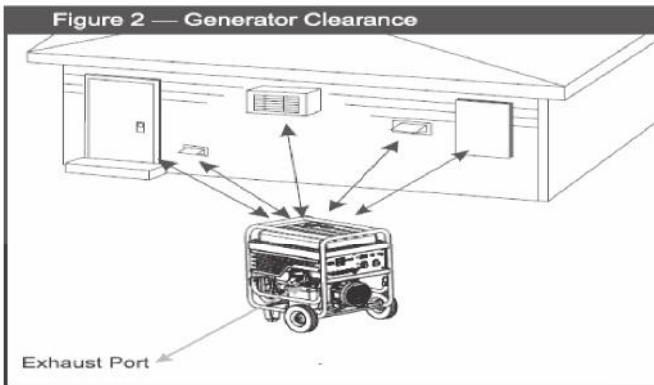

## TO START THE ENGINE

### CAUTION

Exceeding generators wattage/amperage capacity can damage generator and/or electrical devices connected to it.

- See "Don't Overload Generator".
- Start generator and let engine stabilize before connecting electrical loads.
- Connect electrical loads in OFF position, then turn ON for operation.
- Turn electrical loads OFF and disconnect from generator before stopping generator.

1. Disconnect all loads to the generator.
2. Make sure the generator is on a flat surface.
3. Turn off the master switch to ensure that no electrical current is connected to the generator.
4. Turn the fuel valve lever to the ON position. Wait for a minute for the fuel to enter the carburettor (for first time use).

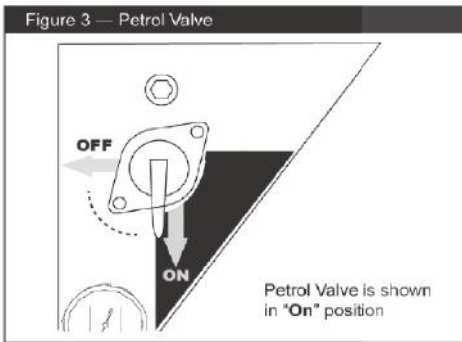

## PUSH BUTTON START AND REMOTE CONTROL START

1. Turn the power switch to ON position.
2. Push the START / STOP button on panel, Or use the remote to start the generator.

### There are 2 methods to stop the generator :

1. Push the START/STOP button, or use the remote key.
2. Then turn the power switch to OFF position.  
Or turn the power switch to OFF position directly.

**Note:**

If the engine starts after 3 times but fails to run, or if the generator shuts down during operation, make sure the generator is on a level surface and check the oil level is adequate. The generator is equipped with a low oil protection sensor and will cause the generator to cut out if the oil is insufficient.

**USING THE RECOIL START**

1. Using recoil start to start the engine – turn the engine switch to the ON position. Pull the starter grip lightly until you feel the resistance, then pull the start cord out briskly and rapidly. Allow start cord to return slowly.
2. When engine starts, move the choke lever slowly to the RUN position.
3. Under long, continuous-run operating conditions, be prepared to check the fuel level through the fuel gauge on the top. Never refuel when the generator is in operation.

 <p><b>WARNING</b></p>	<p>A running engine is hot enough to ignite fuel. Never add fuel or remove gas cap if engine is running or still hot. Let cool at least 2 minutes. Check engine oil level each time you refuel. Change oil after the first 20 operating hours and at least every 50 operating hours thereafter.</p> <p>Never open fuel cap while engine is running. Hot fuel can spray over face and body. Hearing can be damaged from prolonged, close-range exposure to the type of noise produced by this generator. The use of ear plugs or other hearing protection device is recommended for a person working within 4-6 metres of the running generator.</p> <p>Loose or dangling apparel can become entangled in moving parts. Metal jewellery can conduct electricity. Never wear jewellery or loose-fitting clothing when operating the generator.</p>
---	--

**ENGINE SPEED**

Engine speed has been factory set to provide safe operation. Tampering with the engine speed adjustment could result in the overheating of attachments and could cause a fire.

 <p><b>WARNING</b></p>	<p>The generator must be run at the correct speed in order to produce the proper electrical voltage and frequency. Failure to do so could result in damage to equipment powered by the generator and possible injury to the individual.</p>
--	---

**CONNECTING LOADS**

You will want to be careful when connecting loads so as to not overload the generator, especially if you are powering devices with motors that require a higher starting power load. Instructions are provided below for connecting loads when you are using the generator as a portable power source.

 <p><b>WARNING</b></p>	<p>Do not overload generator. Make sure that combined starting and running loads do not exceed rated capacity of generator. Overloading the generator can cause damage to the generator and attached electrical devices and may result in fire.</p>
---	---

## 240V AC CONNECTION

Connect electrical loads one at a time according to the following instructions:

1. Allow engine to reach operating speed by allowing it to warm up for approximately 5 minutes before connecting electrical devices.
2. Check the devices to be connected are turned OFF before connecting them to the AC outlets.
3. After the engine is warmed up, begin by connecting the items that require the highest wattage first.

The recommended sequence is as follows:

1. Connect items with motors such as refrigerators, freezers, air conditions or small hand tools, one at a time.
2. Let each motor stabilise before connecting the next device.
3. Connect any lights you are planning on powering.
4. Connect voltage sensitive equipment such as electronics via surge protectors. Plug devices such as TV's, computers and microwaves into a voltage surge protector, then plug the surge protector into the generator.

## 12V DC CONNECTION

The generator is fitted with a socket outlet specifically for connection to a lead acid battery for charging. The output voltage is 12V with maximum output current of 8.3A. The generator will charge lead acid batteries of various sizes from small to large.

DO NOT attempt to charge Nicad, Nickel metal hybrid, or lithium type batteries. ONLY use provided charger cable. Read the following section for details.

## CHARGING A BATTERY

 <b>WARNING</b>	It's suggested to wear protective clothing, gloves and eye protection when handling and working with lead acid batteries. For operators with pacemakers or similar medical devices and conditions, it is recommended not to attempt the following procedure.  DO NOT attempt to charge a lead acid battery in confined areas. Ensure the charging process takes place in an area where there is fresh air circulating.
---	--

Remove the battery from the car, boat or any other device. The battery MUST be totally isolated from any other circuitry. After connection to the battery, RECHECK to ensure the connections are as below:

- Insert the T-shaped plug to the generator with the opposite end of the cable connected to the battery.
- Connect the positive (+) alligator clip (red) to the positive (+) terminal on the battery.
- Connect the negative (-) alligator clip (black) to the negative (-) terminal on the battery.
- Start the generator and allow the generator to warm up.
- Check the DC reset button is pressed inward (ON position).

The battery charging process is now underway. To disconnect the battery on charge, STOP THE ENGINE and remove the plug from the generator socket and disconnect the cable clamps from the battery, in that order.

Note: The battery charging socket should only be used while the 240V AC outlets are NOT being used. If the battery was originally in a low level of charge, the battery will take many hours to recharge fully. The time frame will depend on the size of the battery.

 <b>WARNING</b>	<p>DO NOT leave battery charging unattended. Charging battery for a long period of time can damage the battery once the battery is full.</p> <p>Over-charging or over-heating can damage the battery, the water and acid solution</p>
<b>CAUTION</b>	<p>Exceeding the rated capacity of your generator can result in serious damage to your generator and connected apparatus.</p>

- The DC circuit has a circuit breaker to protect the generator from overloading.
- If the circuit breaker trips, unplug all electrical apparatus from the generator.
- Let the overload cut out switch cool down and remove the load from the DC circuit.
- Press the DC reset button.
- When re-connecting the DC load, reduce the load which previously overloaded the generator.

Note: Some batteries, depending on the size, battery condition or level or charge may exceed the max current output from the generator and trip the overload DC circuit breaker.

## STOPPING THE GENERATOR

Stop the engine using the following steps:

1. Turn off all appliances. Disconnect all loads to the generator. Never start or stop the generator with electrical devices plugged in or turned on.
2. Allow the generator to idle for 2-3 minutes and cool down.
3. Turn the engine switch to the OFF position. DO not leave the generator until it has completely stopped.
4. Turn the RCBO switch to OFF position.
5. Turn the fuel valve to OFF position.

### Attention:

Ensure the generator is in a well-ventilated area as the unit will remain hot even after switching it off.

 <b>WARNING</b>	<p>Fuel and its vapours are extremely flammable and explosive which could cause burns, fire or explosion resulting in death, serious injury and/or property damage.</p> <p>DO NOT stop engine by moving choke control to "Start" position.</p>
--	--

### **During an emergency:**

If there is an emergency and the generator must be stopped quickly, push the engine control switch to the OFF position immediately.

## CARBON BUILD UP

Running the generator at low loads for extended periods can lead to carbon build-up on the spark plug which may subsequently require cleaning. Carbon build-up can be a problem on generators as the loading on the motor can vary considerably. If the generator has been used for less than 50% of rate load, there is a chance of carbon build-up developing. Carbon build up in the motor

can be reduced by operating the generator at approximately 75% of rated load for 25% of the time the generator is used.

For instance, if the generator is used for 4 hours on low wattage, run the generator for 1 hour at around 75% of rating. If the generator is being used for solely charging a battery, its recommended to run the 240V at around 500W for the generators up to 2000W if the charging cycle will be run for many hours. When charging is complete, try and run the generator at around 75% of rate load for an hour or so. Unleaded fuel without ethanol generally gives the best results.

## **An Important Message about Temperatures**

Your engine is designed and rated for continuous operation at ambient temperatures up to 40 degrees Celsius. When your generator is needed, it may be operated at temperatures ranging from -15 degrees Celsius to 50 degrees Celsius for short periods. If the generator is exposed to temperatures outside this range during storage, it should be brought back within this range before operation. In any event, the generator must always be operated outdoors, in a well-ventilated area and away from doors, windows and other vents.

When operated above 25 degrees Celsius there may be a decrease in power. Maximum wattage and current are subject to and limited by such factors as fuel BTU content, ambient temperature, altitude, engine condition etc. Maximum power decreases about 3.5% for each 1000 feet above sea level and will also decrease about 1% for each -12.2 degrees Celsius above 16 degrees Celsius ambient temperature.

## **2 WIRE AUTO START**

Automatic Electric Starting of the MX9000AS by 2-Wire Auto Start.

1. Verify the battery is properly installed and both battery cables are attached.
2. If the generator is left in non-operating standby whilst in auto-start mode for an extended period or it starts and stops frequently with a short operating time, the battery may become excessively discharged and unable to automatically start the generator. To ensure reliable service, it is recommended that the battery be connected in parallel to a main(12V) or solar-powered automatic maintenance battery charger(12V).
3. Connect electrical cords or devices into the 240-Volt AC or 12-Volt DC outlets, as required.
4. Switch the 240-Volt AC Main Circuit Breaker to the ON position and ensure that the DC breaker is pushed in.
5. Connect the 2-wire auto start terminals to an external “dry” or voltage-free circuit that will provide the start and stop commands to the generator by closing and opening the circuit, respectively.
6. Move the fuel shut off valve to the ON position.
7. Push the auto start control switch to the ON position.



8. Do not touch the choke lever. It will automatically adjust itself to the correct position if the generator's battery is sufficiently charged.
9. Upon receiving a "start" signal by closing of the external 2 wire remote control circuit, the generator will start automatically. The generator will continue running until it receives a remote "stop" command or is manually stopped or runs out of fuel.
10. When the two-wire control switch is pressed ON, the one - key start, cannot control the starting of the generator set.
11. Only the two-wire control socket (two core aviation) socket can control the start and stopping of the generator set.
12. After 48 hours of turning off the generator set with the one key start, the generator set will enter the power saving mode. At this time, only the "one key start" switch will reenergize the generator set to wake up the starter module.
13. Only after the gen set has been woken then the start stop function of the generator set can be controlled again.
14. When the two-wire control switch is pressed OFF, only the one -key starter, can control the starting or stopping of the generator set.

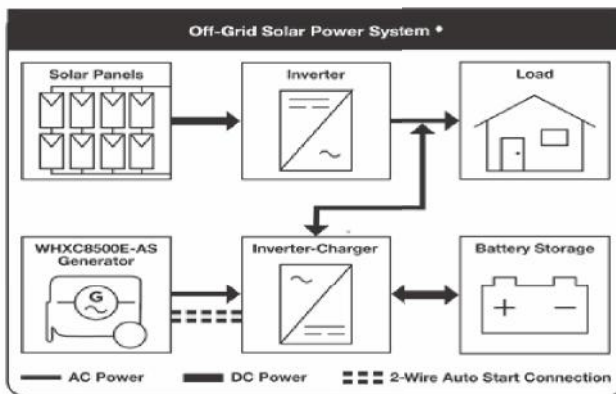

† Depending on system configuration, the generator can automatically provide backup to recharge the storage battery and / or feed in power to supply the load.

## **STORAGE**

When you are finished using the generator, you must:

- Disconnect all loads
- Shut off fuel supply
- Disconnect spark plug and battery
- Store the generator properly
- Plan on operating the engine regularly unless the generator is prepared for long-term storage.

### **DISCONNECT LOADS AND TURN OFF THE FUEL SUPPLY**

When you are finished using the generator, disconnect all loads and turn off fuel supply.

- Make sure all devices that were connected to the generator's outlets have been disconnected.
- Check to be sure line shut-off valve is in OFF position.

### **COOL THE ENGINE BEFORE STORING**

Let engine cool for at least five minutes before storing. A hot engine can be a fire hazard.

### **CHOOSE A STORAGE LOCATION**

Store the generator in a location that is clean, dry, away from sources of heat, open flames, sparks, or pilot lights and is not subject to extreme high or low temperatures. Residual fuel in the tank could ignite even if the generator's fuel tank is empty.

Note: Do not store with battery charger always connected. Batteries that are over-charged can boil dry and produce excessive amounts of hydrogen, an explosive gas.

### **PREVENT ACCIDENTAL STARTING- SPARK PLUG**

Remove spark plug (s) in order to ensure the generator cannot be started accidentally in a storage location or by untrained persons.

### **PREVENT ACCIDENTAL STARTING- BATTERY**

To prevent accidental starting, disconnect the battery before storage.

1. Disconnect negative (-) battery terminal first.
2. Disconnect positive (+) battery terminal last.

### **OPERATE THE ENGINE REGULARLY**

The generator should be operated regularly to maintain the condition of internal parts. At least every four weeks, start the engine and let it run for 10 to 15 minutes with a small load plugged in such as a lamp or fan.

Monthly operation of the generator will dry out any moisture that has accumulated in the windings which if left, can cause corrosion. It will also ensure that the unit is operating properly should it be needed in an emergency.

## **PERFORM REGULAR MAINTENANCE**

Perform periodic maintenance as directed in this manual to keep the generator in safe working condition.

## **PREPARE ENGINE FOR LONG TERM STORAGE**

If you will not be able to operate the generator regularly, you must prepare the engine for long term storage to prevent gum deposits from forming and causing malfunction of the engine. Prepare the generator for long term storage by removing all fuel from the tank and carburettor OR adding fuel stabiliser to the petrol (following manufacturer's instructions).

Fuel stabiliser steps:

1. Ensure tank is full
2. Add fuel stabiliser to fuel tank
3. Run engine at least 10 minutes after adding stabiliser to allow it to enter the fuel system.
4. Shut off engine.
5. Disconnect spark plug wire and remove spark plug.
6. Add one teaspoon oil through spark plug opening.
7. Place rag over spark plug hole and turn starter (or pull the recoil) a few times to lubricate the combustion chamber. This will distribute the oil and protect the cylinder wall from corrosion during storage.
8. Replace spark plug, but do not reconnect the spark plug wire.

## **REMOVAL FROM STORAGE**

Follow the normal procedures for pre-operation checks and starting. Use only fresh fuel to refill the tank, if necessary, rather than re-using the old fuel.

A battery may lose some charge when not in use for prolonged periods of time. If the battery is unable to crank the engine, recharge the battery with a 12V battery charger.

If oil was inserted into the cylinder prior to storage, the exhaust may smoke for a short while after starting the generator. This is normal and will cease within a minute or so of running time.

## **TRANSPORTING**

If the generator has been used, allow it to cool for at least 15 minutes before loading the generator on the transport vehicle. A hot engine and exhaust system can burn you and can ignite some material.

Take care not to drop or strike the generator when transporting. Do not place heavy objects on the generator. When transporting the generator, turn the engine switch and the fuel valve lever OFF and keep the generator level to reduce the possibility of fuel leakage.

## MAINTENANCE & REPAIR

Proper care for your generator is essential for safe, economical and trouble free operation. It will also reduce pollution. For all maintenance and repair instructions, please read the following information.

 <b>WARNING</b>	<b>ALWAYS</b> shut off the generator, disconnect the spark plug, disconnect the battery (negative cable first, then positive cable second), and discharge the capacitor before cleaning, adjusting, or servicing the engine. Improper maintenance, or failure to correct a problem before operation, can cause a malfunction in which you can be seriously hurt or killed.
--	---

## SAFETY

Follow these safety rules whenever you service the generator:

- Turn off generator. Always turn off generator and remove spark plug(s) or spark plug wire(s) before working on the engine or generator to prevent accidental starting.
- Replace guards. Make sure all guards and shields are replaced after servicing the generator.
- Repair. Major service, including the installation or replacement of parts, should be performed only by a qualified electrical service technician. Obtain factory approved parts.
- Replacement parts. If a part needs replacement, only use factory approved repair parts. Replacement parts that do not meet specifications may result in a safety hazard or poor operation of the generator and will void the warranty.

 <b>CAUTION</b>	Be careful not to touch the muffler during or just after the engine has been running.
--	---

## INSPECT FUEL SYSTEM/CHECK FOR LEAKS

Inspect the fuel system and check for leaks on a regular basis. Look for signs of leaks or deterioration, chafed or spongy fuel hose, loose connections, loose or missing fuel hose clamps, damaged petrol tank or defective shut-off valve.

## CLEAN & INSPECT SPARK ARRESTER

Depending on the fuel used, the type and the amount of lubricant used, and/or your operating conditions, the exhaust part and muffler may become blocked with carbon deposits. If you notice power loss, you may need to remove these deposits to restore performance.

- Allow the engine to cool completely before servicing the spark arrester.
- Remove the spark arrester, check and clean with a wire brush.
- Replace spark arrester if its damaged.

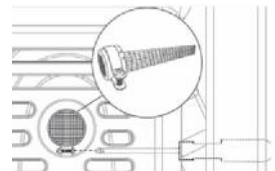

## KEEP THE GENERATOR CLEAN

If dust or debris accumulates on the generator, clean the generator with a damp cloth or soft bristle brush. DO NOT allow air intakes to become blocked.

Note: DO NOT spray generator with a garden hose or pressure washer. Water may enter the generator and cause damage to the rotor, stator or internal windings.

## PETROL TANK FILTER

- Stop the engine and turn off the main switch
- Turn the fuel valve to the OFF position
- The petrol tank filter is located directly under the petrol cap to protect impurities from entering the fuel tank during refuelling.
- Remove the filter and wash thoroughly in a solvent and let dry.
- Re- assemble.

## SPARK PLUG REPLACEMENT

Proper spark plug clearance ensures the engine's normal running:

- Stop the engine and turn off the main switch
- Remove the spark plug wire from the spark plug and then remove spark plug from the generator
- Inspect spark plug for damage and clean with a wire brush before installing. Replace spark plug if necessary.
- Adjust the electrode gap to 0.7 to 0.8 mm if necessary.
- Seat spark plug in position and thread by hand to prevent cross threading. Reconnect spark plug wire.
- Tighten spark plug and put the cap back on the spark plug.

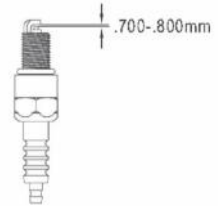

## CLEANING AIR FILTER

Maintaining an air filter in proper condition is essential. Dirt induced through improperly installed, improperly serviced or inadequate elements damages and wears out engines. Stop the engine and turn off the main switch.

- Remove the air cleaner cover and locate the air filter.
- Remove the air filter and wash it in hot soapy water then let it dry.
- Lubricate the air filter with clean engine oil and squeeze to remove excess oil.
- Replace air filter if necessary.
- Secure the air filter and cover back on to the side panel.

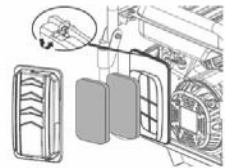

## REPLACING FUEL FILTER

Occasionally the fuel inline filter may become clogged and need replacing.

- Remove the fuel line from both sides of the filter by squeezing the ends of the retaining clip with pliers.
- Slide the fuel line off and replace with new fuel filter.

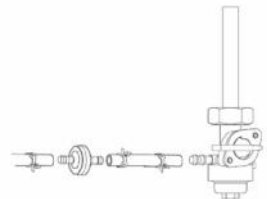

reinstall fuel lines to new fuel filter.

## MAINTENANCE SCHEDULE

	<b>WARNING</b>	To prevent accidental starting that could cause serious personal injury, always switch off the engine and disconnect the spark plug wire/lead before carrying out maintenance work.
---	----------------	---

PERIODIC MAINTENANCE						
Item	Remarks	Pre-operation check (daily)	Initial 1 month or 20 Hrs	Every 3 months or 50 Hrs	Every 6 months or 100 Hrs	Every 12 months or 300 Hrs
Spark Plug	Check condition, adjust gap and clean. Replace if necessary.				*	*
Engine Oil	Check oil level.	*				
	Replace.		*		*	
Air Filter	Clean.	*		*		
	Replace.					*
Fuel Filter	Clean fuel drain filter. Replace if necessary.				*	
Fuel Inline	Check fuel hose for crack or damage. Replace if necessary.	*				
Exhaust System	Check for spark arrester. Retighten or replace if necessary.		*			
	Check muffler screen. Clean/replace if necessary.		*			
Carburettor	Check choke operation.	*				
Starting System	Check recoil starter operation.	*				
Fittings/ Fasteners	Check all fittings and fasteners, correct if necessary.				*	

### Additional Notes:

Service more frequently if used in a dusty environment.

Always have your generator serviced by an approved dealer.

Failure to follow the service schedule could result in non-warrantable failures.

### GENERAL RECOMMENDATIONS

Regular maintenance will improve the performance and extend the life of the generator. See any authorised dealer for service. The warranty does not cover items that have been subjected to operator abuse or negligence. To receive full value from the warranty, the operator must maintain the engine as instructed in the manual. Some adjustments should be made periodically to properly maintain your generator. All service and adjustment should be made at least once each season. Follow the requirements in the Maintenance Schedule chart above.

Notice once a year you should clean or replace the spark plug and replace the air filter. New spark plugs and clean air filter assures proper fuel-air mixture and helps your engine to run better and last longer.

## MAINTENANCE LOG

### MAINTENANCE LOG

Your Maxwatt generator is protected by a 2 year limited warranty (3 month on battery) that covers the product for normal use. The warranty statement is found on the back of this manual. You must understand that negligence or misuse is not covered in the warranty and failure to properly maintain and service the engine, can void your warranty. Please keep records of your service, maintenance and repair history to ensure the product has all the required information to action your warranty, if so required.

No.	Service Date	Hours of Operation	Action	Comments
<b>Please note the date and store of purchase. Keep your receipt.</b>				
<b>Date of Purchase:</b>				
<b>Maxwatt batch number or serial number:</b>				
0				
1				
2				
3				
4				
5				
6				
7				
8				
9				
10				
11				
12				
13				
14				

Normal maintenance such as spark plugs, battery, air filters, adjustments, fuel system cleaning and obstruction due to build up is not covered by the warranty.

# TROUBLESHOOTING

## GENERATOR TROUBLE SHOOTING GUIDE

First check below common start up issues:

Does the unit have fuel in it? Is the engine oil filled up to the threads?

Have you changed/cleaned spark plug?

If the above checklist has been conducted, please refer to the points below:

Problem	Possible Cause	Suggested Correction
Engine will not start	Low on fuel or oil content	A fuel or oil
	Engine On/Off switch is "Off" position	Turn the engine switch to "On" position
	Faulty spark plug	Replace or clean spark plug
	Choke lever in wrong position	Adjust choke lever
	Fuel shut-off valve in closed position	Open fuel shut-off valve
	Unit loaded during start-up	Remove load from unit
	Spark plug wire loose	Attach wire to spark plug
	Old fuel in carburettor	Open drain screw until fresh fuel runs through
No electrical output	Faulty receptacle	Have service centre replace receptacle
	Overload has been triggered	Remove all appliances. Stop the generator, and restart. Reconnect appliances but with reduced load
	Faulty power cord	Have an electrician replace cord
	Master 240V switch turned off	Check the master 240V switch is ON
Repeated overload	Overload	Reduce load
	Faulty cords or equipment	Check for damaged, bare, or frayed wires on equipment. Replace.
Generator overheating	Generator overloaded	Reduce load
	Insufficient ventilation	Move to adequate supply of fresh air
	Blocked exhaust / spark arrestor	Spark arrestor and muffler screen should be cleaned regularly.
Generator keeps stopping or is operating rough	Check oil level	Add oil so oil is at the correct level
	Generator not sitting on flat and level surface	Move generator to a level and flat surface
	Motor needs to be cleaned of carbon	Remove, check and clean spark arrestor if needed. Remove, clean or replace spark plug
	Fuel not getting through the motor	Check fuel filter, if clogged, replace.
	Blocked exhaust / spark arrestor	Spark arrestor and muffler screen should be cleaned regularly
No DC output	DC circuit breaker requires resetting	Remove load from generator. Allow the reset to cool and then press reset
	Reset button continues to open when load is applied	Check polarity to battery being charged. Red to positive, black to negative



# WIRING DIAGRAM

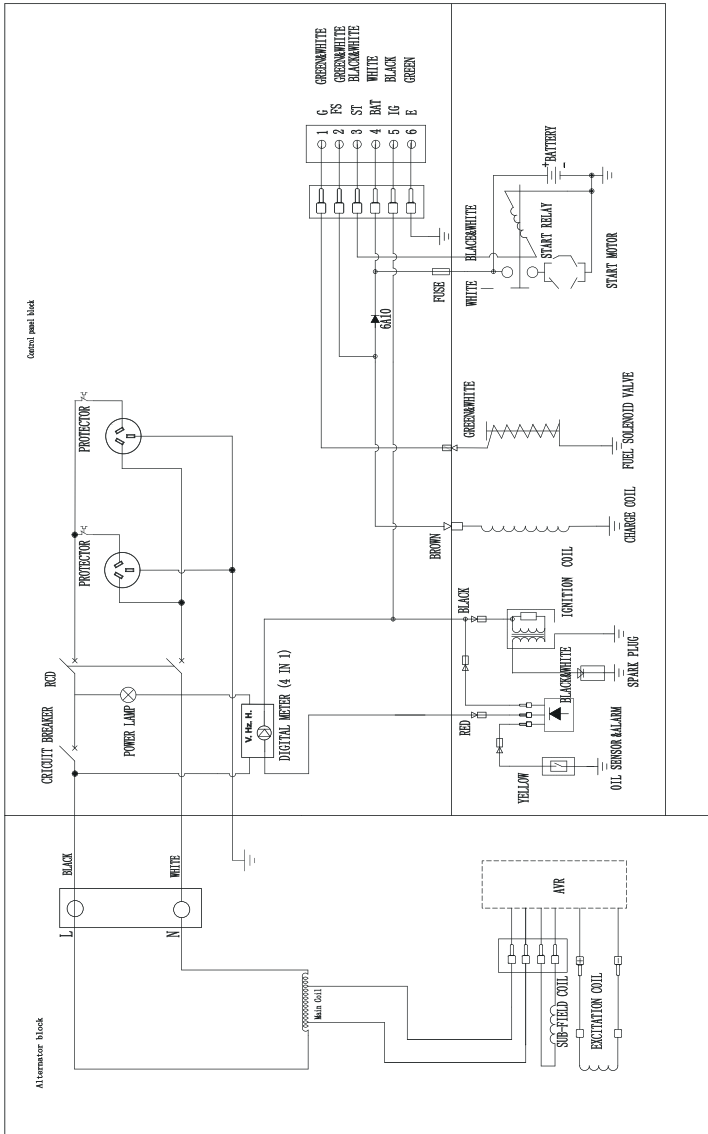

# LABEL



<p><b>⚠ DANGER</b></p> <p> Risk of fire. Check for any fuel overflow or leakage. Stop the engine before refueling.</p> <p> Generator is a potential source of electric shock. Do not expose to moisture, rain or snow. Do not operate with wet hands or feet.</p>	<p><b>⚠ DANGER</b></p> <p> Failure to properly ground generator can result in electrocution, especially if the generator is equipped with a neutral kit.</p> <p> Exhaust contains poisonous carbon monoxide gas that can cause unconsciousness or DEATH. Operate in well ventilated, outdoor areas away from open windows or doors.</p>	<p><b>⚠ DANGER</b></p> <p> You could be killed or seriously hurt if you do not follow the Operator's Manual instructions.</p> <p> Do not expose to rain or use in damp locations.</p>	<p><b>⚠ DANGER</b></p> <p>USING A GENERATOR INDOORS CAN KILL YOU IN MINUTES. GENERATOR EXHAUST CONTAINS CARBON MONOXIDE. THIS IS A POISON YOU CANNOT SEE OR SMELL.</p> <p> NEVER USE INSIDE A HOME. ONLY USE OUTSIDE AND ON GARAGE, EVEN IF DOOR FAR AWAY FROM WINDOWS, AND WINDOWS ARE OPEN, DOORS, AND VENTS.</p>
---	---	---	---

**STOP**

**CAUTION!** Your machine has been shipped without engine oil. **DO NOT** add fuel or start the engine before adding oil. See owner's manual for instructions.

**ADVERTENCIA!** Agréguele aceite antes de comenzar.

**OIL SPECIFICATIONS:**  
 SAE 10W-30. Please Refer To Owner's Manual For Capacity.



<b>MAXWATT</b>		MODEL NO.: MX7000ES
AC Voltage: 240V	Frequency: 50Hz	
Current: 20.8A	Phase: Single	
Rated Output: 6.2kVA/5500W	RPM: 3000	
Maximum Output: 7.0kVA/5500W	Power Factor: 0.8	
Serial No. _____		
Production Date _____		

**389cc**  
 PETROL ENGINE

**MAXWATT**  
 POWER WHEN YOU NEED IT

**AIR FILTER**

Clean filter every 50 hours of use.  
 (See manual for instructions)



## **WARRANTY INFORMATION**

### **2 YEAR TRADE WARRANTY**

#### **Express Warranty**

Subject to the exclusions set out below, we warrant that this product will be free from defects in materials or workmanship for 24 months from the date of purchase.

The benefits conferred by this warranty are in addition to all rights and remedies which you may be entitled to under the Australian Consumer Law and any other statutory rights you may have under other applicable laws. This warranty does not exclude, restrict, or modify any such rights or remedies.

#### **Warranty Exclusions**

This express warranty does not apply where a defect or other issue with the product is caused by normal wear and tear, misuse or abuse of this product.

#### **Consumer Guarantees**

Our goods come with guarantees that cannot be excluded under the Australian Consumer Law. You are entitled to a replacement or refund for a major failure and for compensation for any other reasonably foreseeable loss or damage.

You are also entitled to have the goods repaired or replaced if the goods fail to be of acceptable quality and the failure does not amount to a major failure.

#### **LIMITED WARRANTY POLICY**

“This is a **“walk in”** warranty policy and is limited to the range of generators specified herein”. We recommend that you take the generator to the nearest service agent for assistance. Please visit [www.maxwatt.com.au](http://www.maxwatt.com.au) for more information.

#### **To qualify for this warranty:**

“The warranty applies to the first purchaser and each subsequent owner during the applicable warranty time period”.

#### **What the appointed Service Agent will repair or replace under warranty:**

“The appointed Service Agent will repair or replace, at its sole discretion, any part that is proven to be defective in material or workmanship under normal use during the applicable warranty time period. Warranty repairs will be made without any charge for parts and labour. All parts replaced will be considered as part of the original product and the warranty on such parts will expire coincident with the original product warranty”.

## WARRANTY PROCEDURES:

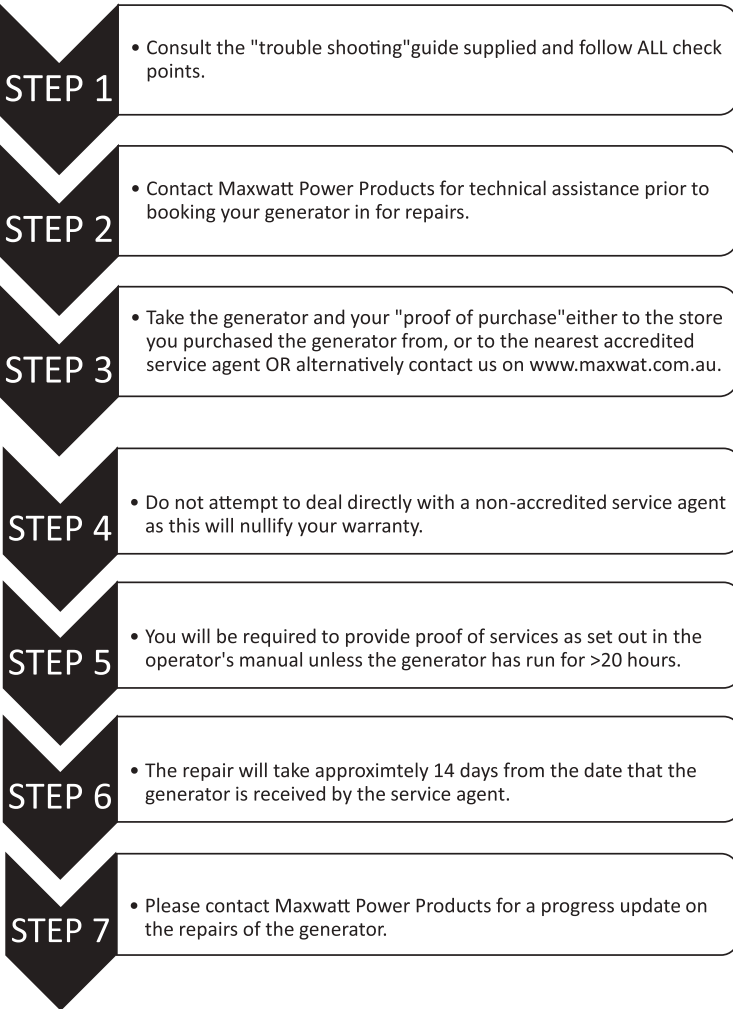

**BELOW IS A LIST OF GENERATORS THAT ARE COVERED UNDER THIS WARRANTY:**

<b>MODELS</b>	<b>WARRANTY PERIOD PRIVATE/RESIDENTIAL</b>	<b>WARRANTY PERIOD COMMERCIAL/RENTAL</b>
<b>MAXWATT ALL MODELS</b>	<b>24 months or 500 running hours which ever come first</b>	<b>24 months or 300 running hours which ever come first</b>

**EXCLUSIONS TO THIS LIMITED WARRANTY INCLUDE**

Neglect in the periodic maintenance as specified in the owner’s manual.

Improper repairs or maintenance including any repairs and or maintenance carried out by a non-accredited service agent.

Operating methods other than those indicated in the owner’s manual.

The use of non-genuine parts and or accessories other than those supplied by an accredited service agent.

Normal wear and tear including but not limited to the fading of painted or plated surfaces.

Consumable parts including but not limited to keys, spark plugs, fuel and oil filters, recoil starter ropes, wheels, lubricants, oil grease and fuel.

Cleaning adjustments and normal periodic maintenance work including but not limited to cleaning of the battery, carburettor, engine oil, fuel tank and injectors.

Over loading resulting in the damage of the AVR, circuit breaker, stator and rotor.

Charging and proper maintenance of the battery.

Correct preparation when using the generator for the first time as set out in the owner’s manual.

Fire damage as a result of but not limited to overloading, incorrect installation, incorrect re-fuelling and any other causes as set out in the owner’s manual.

Damage to any electronic and or electrical appliances connected to the generator.

**BELOW IS A TABLE OF PARTS THAT ARE LIMITED BY THIS WARRANTY**

<b>PART</b>	<b>OUT OF BOX FAILURE</b>	<b>&lt; 20 RUNNING HOURS</b>
<b>STATOR</b>	*	
<b>ROTOR</b>	*	
<b>CIRCUIT BREAKER</b>	*	
<b>AVR</b>	*	
<b>IGNITION COIL</b>		*
<b>SPARK PLUG</b>		*
<b>BATTERY</b>		*
<b>WHEELS AND AXLE</b>		*
<b>HANDLES</b>		*
<b>RECOIL STARTER</b>		*

**\*NOTE:**

**OUT OF BOX FAILURE REFERS TO A MACHINE THAT HAS RUN FOR < 20 MINUTES.**

**DISCLAIMER OF CONSEQUENTIAL DAMAGE AND LIMITATION OF IMPLIED WARRANTIES**

Maxwatt disclaims any responsibility for the loss of time or use of the product, transportation, commercial loss or any other incidental or consequential loss or damage. Any implied warranties are limited to the duration of this written limited warranty policy and procedures manual.

**ONLINE ORDER RETURNS POLICY**

If you believe an item is faulty, you may have rights to a remedy under the Australian Consumer Law. The Australian Consumer Law does recognize that the relevant time period may vary by product (or service) depending on the nature of the goods (or service), the price paid and any representations made about the goods (or service).

Where you believe an item is faulty, it may be necessary for us to send your goods to the manufacturer or their service agent for it to be assessed within a reasonable period of time.

If there is a major failure with the item, you may choose a refund, exchange or repair. If the failure is minor, we will repair the item (or, at our discretion, we may replace the item) within a reasonable time.

Where an item is damaged through misuse or abnormal use, the manufacturer cannot provide a refund, exchange or repair.

Maxwatt requires satisfactory proof of purchase before providing a remedy under the Australian Consumer Law.

## **DAMAGED IN TRANSIT**

Please do not sign for the delivery of goods that are obviously damaged. If damage is only found upon unpacking, then please contact the store that fulfilled your order as soon as possible. Store contact details can be found on your order confirmation email. They will then arrange for the goods to be collected and a refund or replacement item sent out to you. Alternatively, please take the items to your nearest store where they will be able to help you.

## **NOT AS ADVERTISED /INCORRECT ITEM**

If your order arrives and it's not what you ordered, please contact either the store the order came from or on the online support team at [customer@maxwatt.com.au](mailto:customer@maxwatt.com.au).

## **FAULTY PRODUCT**

Please contact the store that fulfilled your order. Store contact details can be found on your order confirmation email. The store will need to assess whether the fault is a major or minor fault and will either arrange for the product to be repaired or replace. Some manufacturers require us to send fault items to them for assessment before we can give you a replacement.

## **CHANGE OF MIND**

Changed your mind? Don't worry. You've got 30 days to get your order back to the store it was sent from and provided its un-used we'll give you a refund minus the costs of any shipping.

## **VALID RECEIPT**

A copy of your in-store purchase receipt or online order confirmation email is required for any return. If returning your product to store, please ensure you take a copy with you.



---

**Distributed by:** Maxwatt Power Products  
Unite 5, 1440 NewCleveland Road, Chandler Queensland Australia