

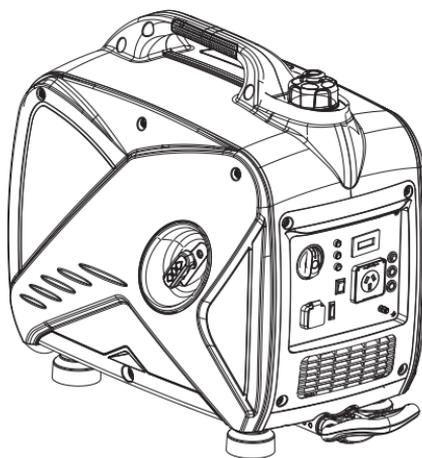

## **2.5kW INVERTER GENERATOR**



**R2500IS - Owner's Manual**



Thank you for choosing the Engel inverter type unleaded engine generator set

Please read this Owner's Manual carefully before operating the unit. Operating safely and correctly can help you get the best results.

All information in this publication is based on the latest product information available at the time of printing. The contents in this manual may be different from the actual parts due to revision and other changes.

Our company reserves the right to make changes at any time without notice and without incurring any obligation. No part of this publication may be reproduced without our company's written permission.

This manual should be considered a permanent part of the generator and should accompany the generator if it is resold.

# SAFETY WARNINGS

Personal safety and property safety of you and others are very important. .  
Please read these messages which is preceded by a symbol  or **NOTICE** carefully.

## DANGER

You **WILL** be **KILLED** or **SERIOUSLY HURT** if you don't follow instructions.

## WARNING

You **CAN** be **KILLED** or **SERIOUSLY HURT** if you don't follow instructions.

## CAUTION

You **CAN** be **HURT** if you don't follow instructions.

## **NOTICE**

Your generator or other property could be damaged if you don't follow instructions.

# CONTENTS

SAFETY WARNINGS.....	2
1. SAFETY INFORMATION.....	5
2. LOCATION OF IMPORTANT LABELS.....	9
3. DESCRIPTION.....	10
3.1 Control panel.....	11
4. CONTROL FUNCTION.....	12
4.1 3 in 1 switch knob.....	12
4.2 Oil warning light (Red).....	12
4.3 Overload indicator light (Red).....	13
4.4 AC pilot light (Green).....	13
4.5 Engine smart control (ESC).....	14
4.6 Fuel tank cap.....	15
4.7 Fuel tank cap air vent knob.....	15
4.8 Ground (Earth) terminal.....	15
5. PREPARATION.....	16
5.1 fuel.....	16
5.2 Engine oil.....	17
5.3 Pre-operation check.....	18
6. OPERATION.....	19
6.1 Starting the engine.....	20
6.2 Stopping the engine.....	21
6.3 Alternating Current (AC) connection.....	22
6.4 USB Socket.....	23
6.5 Application range.....	24
6.6 Voltage/Frequency/Time.....	25

7. MAINTENANCE.....	26
7.1 Spark plug inspection.....	28
7.2 Carburetor adjustment.....	29
7.3 Engine oil replacement.....	29
7.4 Air filter.....	30
7.5 Muffler screen and spark Arrester.....	31
7.6 Fuel tank filter.....	32
7.7 Fuel filter.....	32
8. STORAGE.....	33
8.1 Drain the fuel.....	33
8.2 Engine.....	34
9. TROUBLESHOOTING.....	35
9.1 Engine won't start.....	35
9.2 Generator won't produce power.....	35
10. SPECIFICATIONS.....	36
11. WIRING DIAGRAM.....	37

# 1. SAFETY INFORMATION

Read and understand this owner's manual before operating your generator. It will help you avoid accidents if you get familiar with your generator's safe operation procedures.

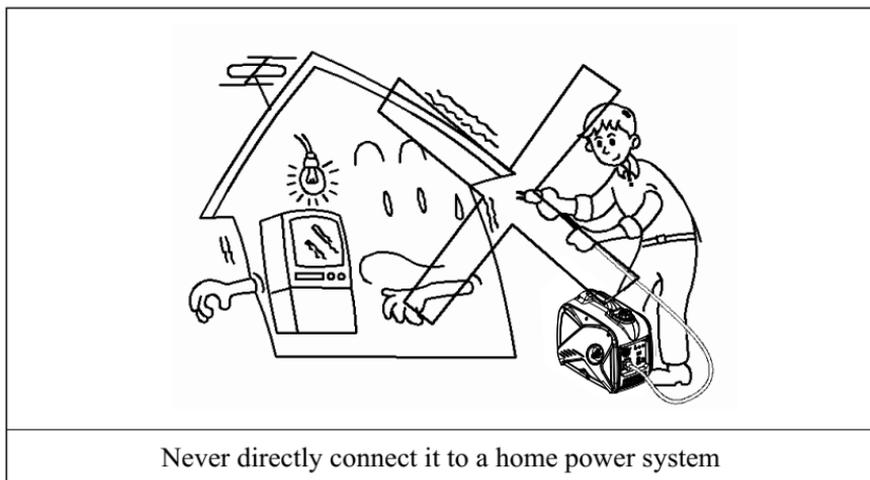

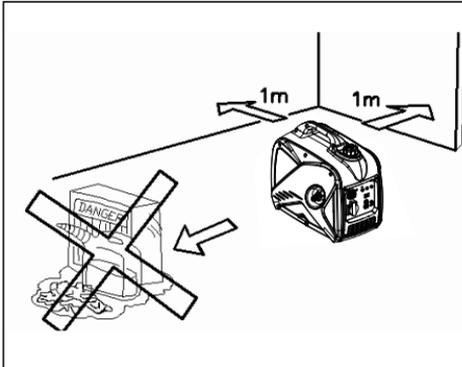

Keep it at least 1m away from  
inflammables



Never smoke when fueling

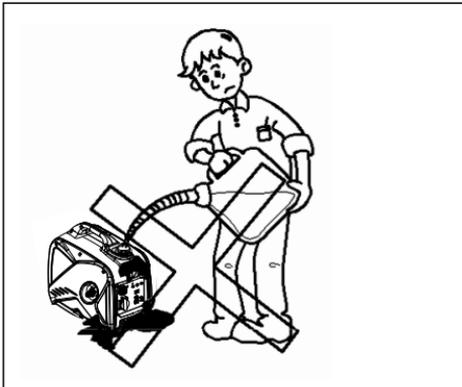

Don't spill when fueling

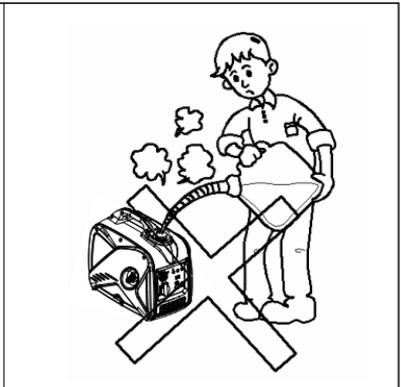

Stop the engine before fueling

## Connections to a Home Power Supply

### NOTICE

If the generator is to be connected to a home power supply as a standby, connection shall be performed by a professional electrician or by another person with proficient electrical skill.

When the loads are connected to the generator, please carefully check whether electrical connections are safe and reliable. Any improper connection may cause damage to the generator, or cause a fire.

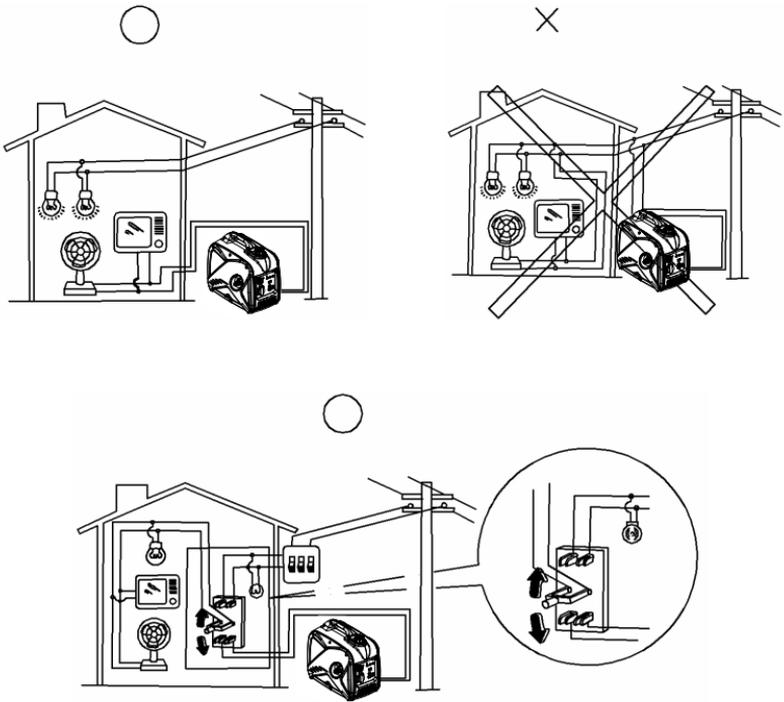

## Generator Ground Circuit

In order to prevent electric shock due to shoddy electrical appliances or wrong use of electricity, the generator must be grounded with a good-quality insulated conductor.

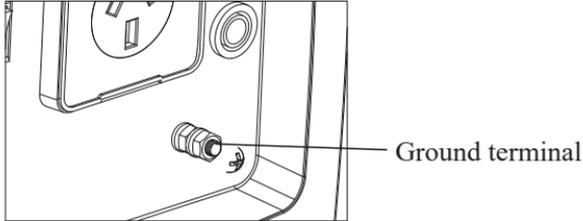

### NOTICE

Make sure no chips, mud and water come inside of the unit from openings of control panel, louver and inverter. Otherwise, the unit may be damaged.

Do not use, transport or store unit with the other objects. Otherwise, fuel leakage may cause unit damage or your other property safety issue when happened.

## 2. LOCATION OF IMPORTANT LABELS

Please read the following labels carefully before operation this machine.

TIP : Maintain or replace safety and instruction labels, as necessary.

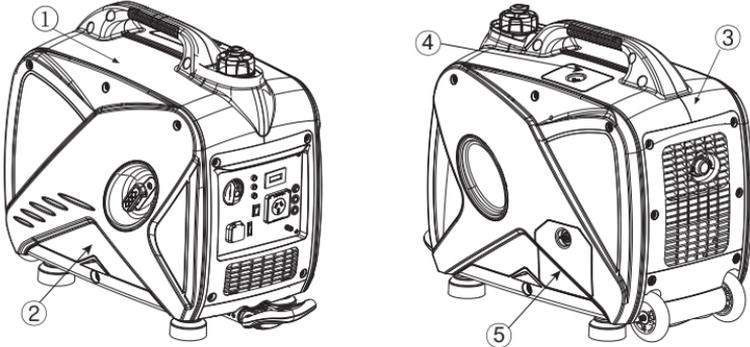

**⚠ WARNING**

- Read the owner's manual and all labels before operating.
- Only operate in well-ventilated areas. Exhaust gas contains poisonous carbon monoxide.
- Check for spilled fuel or fuel leaks.
- Stop engine before refueling.
- Do not operate near flammable materials.
- Electrocutation can occur if generator is used in rain, snow, or near water. Keep this unit dry at all times.
- Electrocutation or property damage can occur. Do not connect this generator to any building's electrical system unless an isolation switch has been installed by a licensed electrician. Refer to the owner's manual.
- When operating the generator:
  - Never place a partition or other barrier around the generator.
  - Do not cover the generator with a box.
  - Do not place any objects on the generator.
- Turn the fuel tank cap air vent knob to 'OFF' after the engine has completely cooled down.

**⚠ DANGER**

The Will be **KILLED** or **SERIOUSLY HURT** if you do not follow the Operator's Manual instructions.

NEVER use inside a home or garage. **EVEN** if doors and windows are open.

Risk of fire. Do not add fuel while the product is operating.

Only use **OUTSIDE** and far away from windows, doors, and vents.

**⚠ WARNING**

Hot exhaust can burn you. Stay away if engine has been running.

↓

**NOTICE ATTENTION**

- Use the specified spark plug only.
- Placard d'exclusionnement à la bougie du type spécifique.



### 3. DESCRIPTION

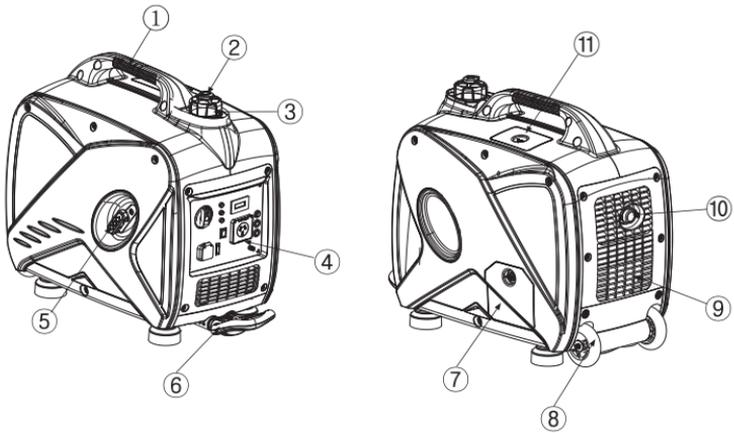

- ① Carrying handle
- ② Fuel tank cap air vent knob
- ③ Fuel tank cap
- ④ Control panel
- ⑤ Recoil starter
- ⑥ Handle
- ⑦ Oil filler cap
- ⑧ Inverter wheel
- ⑨ Louver
- ⑩ Muffler
- ⑪ Spark plug maintenance cover

### 3.1 Control panel

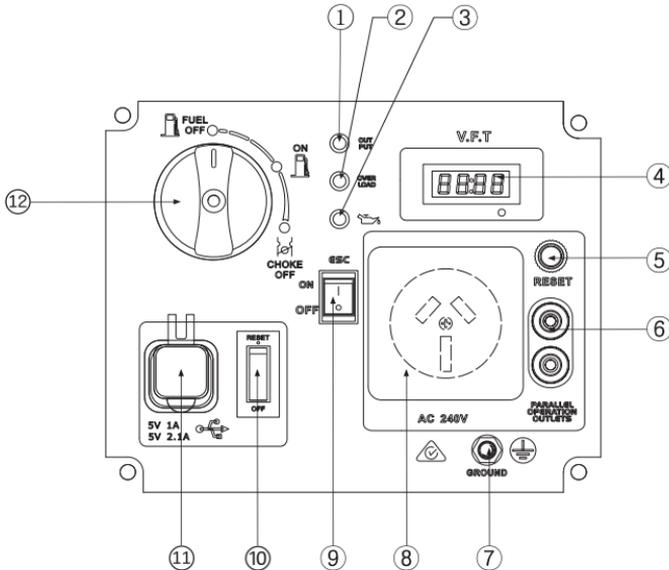

- ① AC pilot light
- ② Overload indicator light
- ③ Oil warning light
- ④ V.F.T Meter (Voltage/Frequency/Time)
- ⑤ AC Reset
- ⑥ Parallel function
- ⑦ Ground (earth) terminal
- ⑧ AC receptacle
- ⑨ ESC(Engine Smart Control)
- ⑩ AC Protector
- ⑪ USB
- ⑫ 3 in 1 switch knob (including start/stop switch, fuel valve and choke)

## 4. CONTROL FUNCTION

### 4.1 3 in 1 switch knob

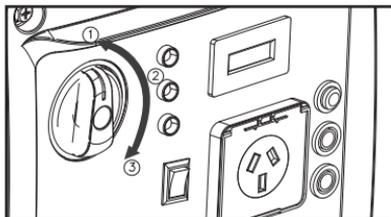

- ① Engine switch \ fuel valve  “OFF”;  
Ignition circuit is switched off. Fuel is switched off.  
The engine will not run.
- ② Engine switch \ fuel valve \ choke  “ON”;  
Ignition circuit is switched on. Fuel is switched on. Choke is switched on.  
The engine can be running.
- ③ Engine switch \ fuel valve \ choke  “CHOKE” ;  
Ignition circuit is switched on. Fuel is switched on. Choke is switched off.  
The engine can be started.

**TIP:** The choke “” is not required to start a warm engine.

### 4.2 Oil warning light (Red)

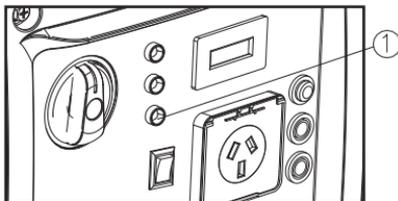

When the oil level falls below the lower level, the oil warning light ① comes on and then the engine stops automatically. Unless you refill with oil, the engine will not start again.

**Tip:** If the engine stalls or does not start, turn the engine switch to “ON” and then pull the recoil starter.

If the oil warning light flickers for a few seconds, the engine oil is insufficient. Add oil and restart.

### 4.3 Overload indicator light (Red)

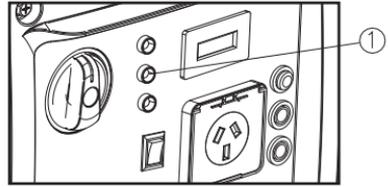

The overload indicator light ① comes on when an overload of a connected electrical device is detected, the inverter control unit overheats, or the AC output voltage rises. Then, the AC protector will trip, stopping power generation in order to protect the generator and any connected electric devices. The AC pilot light (Green) will go off and the overload indicator light (Red) will stay on, but the engine will not stop running.

When the overload indicator light comes on and power generation stops, proceed as follows:

1. Turn off any connected electric devices and stop the engine.
2. Reduce the total wattage of connected electric devices within the rated output.
3. Check for blockages in the cooling air inlet and around the control unit. If any blockages are found, remove.
4. After checking, restart the engine.

**Tip:** The overload indicator light may come on for a few seconds at first when using electric devices that require a large starting current, such as a compressor or a submersible pump. However, this is not a malfunction.

### 4.4 AC pilot light (Green)

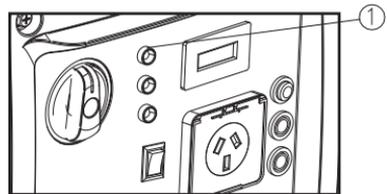

The AC pilot light ① comes on when the engine starts and produces power.

## 4.5 Engine smart control (ESC)



### ① “ON”

When the ESC switch is turned to “ON”, the economy control unit controls the engine speed according to the connected load. The results are better fuel consumption and less noise.

### ② “OFF”

When the ESC switch is turned to “OFF”, the engine runs at the rated r/min(4400r/min) regard-less of whether is a load connected or not.

### **Tip:**

The ESC must be turned to “OFF” when using electric devices that require a large starting current, such as a compressor or a submergible pump.

#### 4.6 Fuel tank cap

Remove the fuel tank cap by turning it counterclockwise.

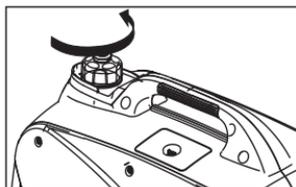

#### 4.7 Fuel tank cap air vent knob

The fuel tank cap ② is provided with an air vent knob to ① stop fuel flow. The air vent knob must be turned to “ON”. This will allow fuel to flow to the carburetor and the engine to run. when the engine is not in use, turn the air vent knob to “OFF” to stop fuel flow.

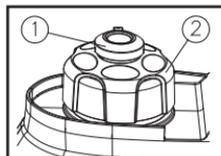

#### 4.8 Ground (Earth) terminal

Ground (Earth) terminal ① connects the earth line for prevention of electric shock. When the electric device is earthed, always the generator must be earthed.

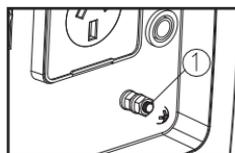

## 5. PREPARATION

### 5.1 Fuel

#### DANGER

- Fuel is highly flammable and poisonous. Check “SAFETY INFORMATION” carefully before filling.
- Do not overfill the fuel tank, otherwise it may overflow when the fuel warms up and expands.
- After filling with fuel, make sure the fuel tank cap is tightened securely.



#### NOTICE

- Immediately wipe off spilled fuel with a clean, dry, soft cloth, since fuel may deteriorate painted surfaces or plastic parts.
- Use only unleaded petrol. The use of leaded petrol will cause severe damage to internal engine parts.

Remove the fuel tank cap and fill the fuel into the tank up to the red level.

- ① Red line
- ② Fuel level

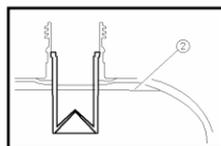
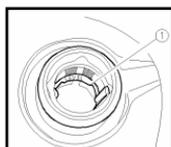

Recommended fuel:

Unleaded petrol

Fuel tank capacity:

Total: 4.5L(1.19 US gal, 0.99 Imp gal)

## 5.2 Engine oil

### NOTICE

The generator has been shipped without engine oil. Do not start the engine until it is filled with the sufficient amount of engine oil.

1. Place the generator on a level surface.
2. Remove the screws ①, and then remove the cover ②.
3. Remove the oil filler cap ③.

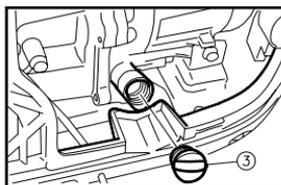
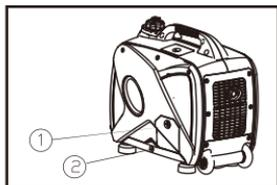

4. Fill the specified amount of the recommended engine oil, and then install and tighten the oil filler cap.
5. Install the cover and tighten the screws.

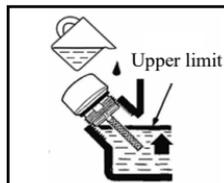
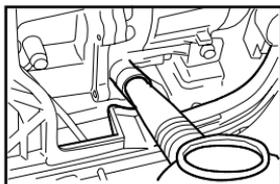

Recommended engine oil: SAE SJ 15W-40

Recommended engine oil grade: API Service SE type or higher

Engine oil quantity: 0.38L

## 5.3 PRE-OPERATION CHECK



If any item in the Pre-operation check is not working properly, have it inspected and repaired before operating the generator.

The condition of a generator is the owner's responsibility. Vital components can start to deteriorate quickly and unexpectedly, even if the generator unused.

### **TIP:**

- Pre-operation checks should be made each time the generator is used.
- Locate set in convenient place, avoiding long extension leads and possible damage to leads by pedestrian or vehicular traffic.
- Maintain normal safety precautions with appliances and accessories as for use on normal reticulated normal supply.

### **Pre-operation check**

#### **Fuel (See page 16)**

- Check fuel level in fuel tank.
- Refuel if necessary.

#### **Engine oil (See page 17)**

- Check oil level in engine.
- If necessary, add recommended oil to specified level.
- Check generator for oil leakage.

#### **The point where abnormality was recognized by use**

- Check operation.
- If necessary, add recommended oil to specified level.
- If necessary, consult our company authorized dealer.

## 6. OPERATION

### WARNING

- Never operate the engine in a closed area or it may cause unconsciousness and death within a short time. Operate the engine in a well ventilated area.
- Before starting the engine, do not connect any electric devices.

### NOTICE

- The generator has been shipped without engine oil. Do not start the engine until it is filled with the sufficient amount of engine oil.
- Do not tilt the generator when adding engine oil. This could result in overfilling and damage to the engine.

### TIP:

The generator can be used with the rated output load at standard atmospheric conditions.

“Standard atmospheric conditions”

Ambient temperature 25°C

Barometric pressure 100kPa

Relative humidity 30%

The output of the generator varies due to changes in temperature, altitude (lower air pressure at higher altitude) and humidity.

The output of the generator is reduced when the temperature, the humidity and the altitude are higher than standard atmospheric conditions.

Additionally, the load must be reduced when using in a confined area, as generator cooling is affected.

## 6.1 Starting the engine

1. Turn the ESC switch to “OFF” ①.

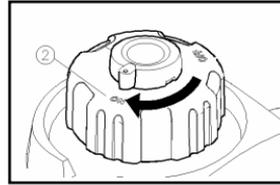

2. Turn the air vent knob to “ON” ② .
3. Turn the 3 in 1 switch to ~~the~~ “CHOKE” ③ ,

- a. Ignition circuit is switched on.
- b. Fuel is switched on.
- c. choke is switched off

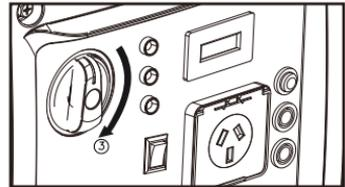

**TIP:** The choke is not required to start a warm engine. Push the choke knob in to the position  “ON”.

4. Pull slowly on the recoil starter until it is engaged, then pull it briskly.

**TIP:** Grasp the carrying handle firmly to prevent the generator from falling over when pulling the recoil starter.

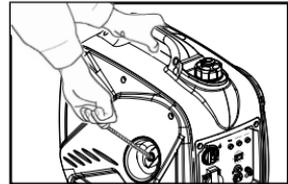

5. After the engine starts, warm up the engine until the engine does not stop when the choke knob is returned to the  “ON” position ④.

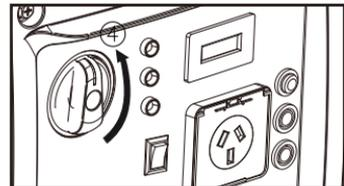

**TIP:** When starting the engine, with the ESC “ON”, and there is no load on the generator:

- In ambient temperature below 0°C (32°F), the engine will run at the rated r/min (4400r/min) for 5 minutes to warm up the engine.
- In ambient temperature below 5°C (41°F), the engine will run at the rated r/min (4400r/min) for 3 minutes to warm up the engine.
- The ESC unit operates normally after the above time period, while the ESC is “ON”.

## 6.2 Stopping the engine

**TIP:** Turn off any electric devices.

1. Turn the ESC to “OFF” ①.

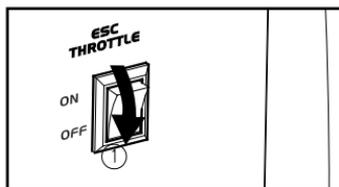

2. Disconnect any electric devices.

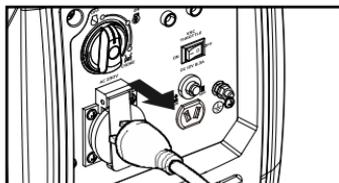

3. Turn the 3 in 1 switch to  “OFF” ②,
  - a. Ignition circuit is switched off.
  - b. Fuel is switched off.

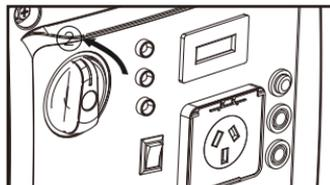

4. Turn the fuel tank cap air vent knob to “OFF” ③ after the engine has completely cooled down.

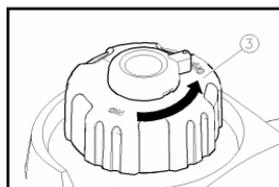

### 6.3 Alternating Current (AC) connection



Be sure any electric devices are turned off before plugging them in.

#### NOTICE

- Be sure all electric devices including the lines and plug connections are in good condition before connection to the generator.
- Be sure the total load is within generator rated output.
- Be sure the receptacle load current is within receptacle rated current.

**TIP:** Make sure to ground (Earth) the generator. When the electric device is earthed, always the generator must be earthed.

1. Start the engine.
2. Turn the ESC to “ON”.
3. Plug in to AC receptacle.
4. Make sure the AC pilot light is on.
5. Turn on any electric devices.

**TIP:** The ESC must be turned to “OFF” to increase engine speed to rated rpm. If the generator is connected to multiple loads or electricity consumers, please remember to first connect the one with the highest starting current, and last connect the one with the lowest starting current.

## 6.4 USB Socket

### FEATURES:

The top is a 1A USB port and the bottom is a 2.1A USB port. It has short circuit protection, anti - access protection, output indicator, etc. functions.

The material is flame resistant (black plastic ABS). The USB ports are equipped with dust proof cover.

### SPECIFICATION:

1. Working power supply: DC 15V ~ 35V.
2. Max. no load output voltage limit is DC5-5.25.
3. The green output indicator is always on.
4. Continuous working hours:  $\geq 500$ h.

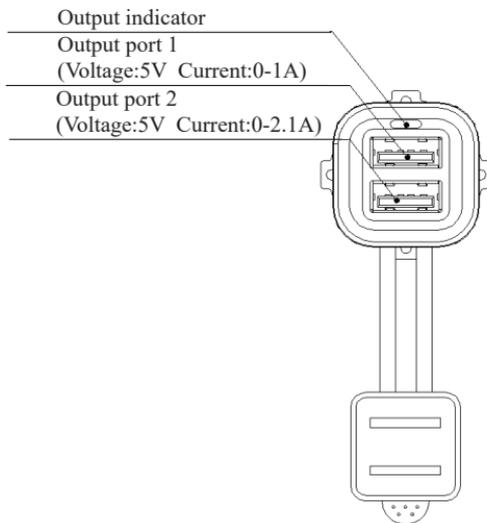

## 6.5 Application range

When using the generator, make sure the total load is within rated output of a generator. Otherwise, generator damage may occur.

AC				
Power factor	1	0.8–0.95	0.4–0.75 (Efficiency 0.85)	
Rated output power	≤2, 300W	≤1, 840W	≤782W	Rated output 1A/2.1A

### TIP:

- Application wattage indicates when each device is used by itself.
- The simultaneous usage of AC and DC power is possible but total wattage should not exceed the rated output.

### EX:

Generator rated output		2, 300W
Frequency	Power factor	
AC	1.0	≤2, 300W
	0.8	≤1, 840W
USB	---	1A/2.1A

- The overload indicator light ① comes on when total wattage exceeds the application range. (See page 13 for more details.)

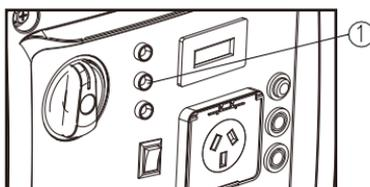

## **NOTICE**

- Do not overload. The total load of all electrical appliances appliance must not exceed the supply range of the generator. Overloading will damage the generator.
- When supplying precision equipment, electronic controllers, PCs, Electronic computers, microcomputer based equipment or battery chargers, keep the generator a sufficient distance away to prevent electrical interference from the engine. Also ensure that electrical noise from the engine does not interfere with any other electrical devices located near the generator.
- If the generator is to supply medical equipment, advice should first be obtained from the manufacturer, a medical professional or hospital.
- Some electrical appliances or general-purpose electric motors have High starting currents, and cannot therefore be used, even if they lie within the supply ranges given in the above table. Consult the equipment manufacturer for further advice.

## **6.6 Voltage/Frequency/Time**

### **INSTRUCTION:**

The digital meter can show voltage output, frequency, cumulative running and single running time, which can be switched by press button.

### **SPECIFICATION:**

- Input Voltage: AC : 90V ~ 250V
- Input Frequency: 50HZ/60HZ
- Display accuracy: voltage 1V, frequency 0.1Hz, cumulative running time 1hr and single running time 1 min.

## 7. MAINTENANCE

The engine must be properly maintained to ensure its operation be safe, economy and trouble-free, as well as eco-friendly.

In order to keep your engine in good working condition, it must be periodically serviced. The following maintenance schedule and routine inspection procedures must be carefully followed:

Items		Frequency	Each time	First 1 month or first 20hrs of operation	Thereafter, every 3 months or every 50hrs of operation	Every year or every 100 hrs of operation
Engine oil	Check-Refill		✓			
	Replace			✓	✓	
Reduction gear oil(if equipped)	Oil level check		✓			
	Replace			✓	✓	
Air filter element	Check		✓			
	Clean			✓		
	Replace				✓	
Deposit Cup ( if equipped)	Clean					✓
Spark Plug	Check-adjust					✓
	Replace		Every year or 250 hrs of operation			
Spark arrester	Clean				✓	
Idling ( if equipped)*	Check-adjust					✓
Valve clearance *	Check-adjust					✓
Fuel tank & fuel filter *	Clean					✓
Fuel line	Check		Every 2 years( change if necessary)			
Cylinder head, piston	Clean up carb-on *		$< 225\text{cc}$ , Every 125hrs $\geq 225\text{cc}$ , Every 250hrs			
* These items should be maintained and repaired by our authorized dealer, unless the owner has appropriate tools and is proficient with mechanical maintenance.						

## NOTICE

- If the petrol engine frequently works under high temperature or heavy load, change the oil every 25 hours.
- If the engine frequently work under dusty or other severe circumstances, clean the air filter element every 10 hours; If necessary, change the air filter element every 25 hours.
- The maintenance period and the exact time (hour), the one which comes first should govern.
- If you have missed the scheduled time to maintain your engine, do it as soon as possible.

## WARNING

**Stop the engine before servicing. Put the engine on a level surface and remove the spark plug cap to prevent the engine from starting. Do not operate the engine in a poorly ventilated room or other enclosed area. Be sure to keep good ventilation in working area. The exhaust from the engine may contain poisonous CO, inhalation can cause shock, unconsciousness and even death.**

## 7.1 Spark plug inspection

The spark plug is important engine components, which should be checked periodically.

1. Remove the cap ①, and use the tool ③ remove the spark plug cap ②, and Insert the tool ⑤ through the hole from the outside of the cover.

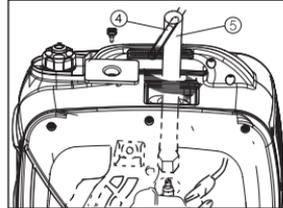
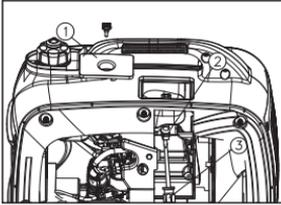

2. Insert the handlebar ④ into the tool ⑤ and turn it counterclockwise to remove the spark plug.
3. Check for discoloration and remove the carbon. The porcelain insulator around the center electrode of spark plug should be a medium-to-light tan color.
4. Check the spark plug type and gap.

Standard Spark Plug:  
A5RTC  
Spark Plug Gap: 0.6-0.8mm (0.024-0.031 in)

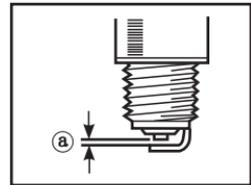

**TIP:** The spark plug gap should be measured with a wire thickness gauge and, if necessary, adjusted to specification.

5. Install the spark plug.

Spark Plug Torque: 12.5 N\*m (1.25kgf\*m, 9 lbf\*ft)

**TIP:** If a torque wrench is not available when installing a spark plug, a good estimate of the correct torque is 1/4-1/2 turn past finger tight. However, the spark plug should be tightened to the specified torque as soon as possible.

6. Install the spark plug cap and spark plug cover.

## 7.2 Carburetor adjustment

The carburetor is a vital part of the engine. Adjusting should be left to our company authorized dealer with the professional knowledge, specialized date, and equipment to do so properly.

## 7.3 Engine oil replacement

### **⚠ WARNING**

Avoid draining the engine oil immediately after stopping the engine. The oil is hot and should be handled with care to avoid burns.

1. Place the generator on a level surface and warm up the engine for several minutes. Then stop the engine and turn the 3 in 1 switch knob and fuel tank cap air vent knob to “OFF”.
2. Remove the screws ① and then remove the cover ②.

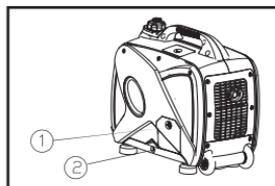

3. Remove the oil filler cap ③.

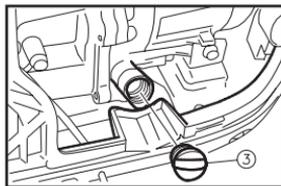

4. Place an oil pan under the engine. Tilt the generator to drain the oil completely.
5. Replace the generator on a level surface.

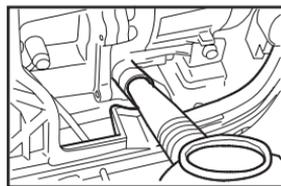

### **NOTICE**

**Do not tilt the generator when adding engine oil. This could result in overfilling and damage to the engine.**

6. Add engine oil to the upper level.

Recommended engine oil: SAE SJ 15W-40

Recommended engine oil grade: API Service SE type or higher

Engine oil quantity: 0.38 L

7. Wipe the cover clean, and wipe up any spilled oil.

### NOTICE

**Be sure no foreign material enters the crankcase.**

8. Install the oil filler cap.

9. Install the cover and tighten the screws.

## 7.4 Air filter

1. Remove the screws ①, and then remove the cover ②.

2. Remove the screw ③ and then remove the air filter case cover ④.

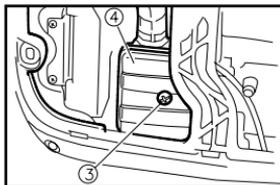
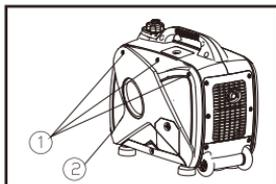

3. Remove the foam element ⑤.

4. Wash the foam element in solvent and dry it.

5. Oil the foam element and squeeze out excess oil.

The foam element should be wet but not dripping.

### NOTICE

**Do not wring out the foam element when squeezing it. This could cause it to tear.**

6. Insert the foam element into the air filter case.

**TIP:** Be sure the foam element sealing surface

matches the air filter so there is no air leak.

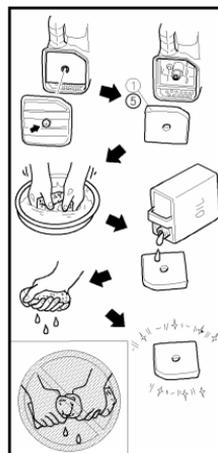

**The engine should never run without the foam element; excessive piston and cylinder wear may result.**

7. Install the air filter case cover in its original position and tighten the screw.
8. Install the cover and tighten the screws.

## 7.5 Muffler screen and spark arrester



**The engine and muffler will be very hot after the engine has been run. Avoid touching the engine and muffler while they are still hot with any part of your body or clothing during inspection or repair.**

Remove screws ①. Remove spark arrester ②. Check the spark arrester. Carefully clean the spark arrester with a soft wire brush. If the spark arrester is damaged, replace the spark arrester.

To install the spark arrester, align the mounting holes in the spark arrester with the mounting holes on the muffler. Insert screws ① and tighten securely.

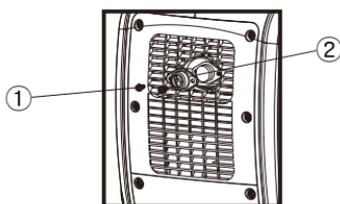

### NOTICE

**When cleaning, use the wire brush lightly to avoid damaging or scratching the muffler screen and spark arrester.**

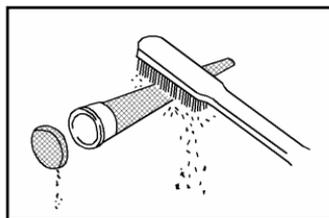

## 7.6 Fuel tank filter



**Never use petrol while smoking or in the vicinity of an open flame.**

1. Remove the fuel tank cap and filter.
2. Clean the filter with petrol.
3. Wipe the filter and install it.
4. Install the fuel tank cap.

**Be sure the fuel tank cap is tightened securely.**

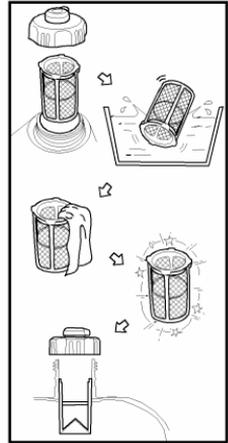

## 7.7 Fuel filter

1. Remove the screws ①, and then remove the cover ②, and drain the fuel ③

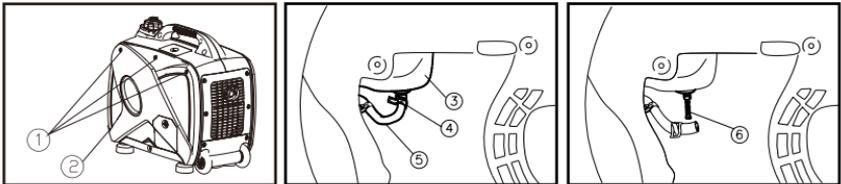

2. Hold and move up the clamp ④, then take off the hose ⑤ from the tank.
3. Take out the fuel filter ⑥.
4. Clean the filter with petrol.
5. Dry the filter and put it back into tank.
6. Install the hose and clamp, then open the fuel valve to check whether it is leak.
7. Install the cover and tighten the screws.

## 8. STORAGE

Long term storage of your machine will require some preventive procedures to guard against deterioration.

### 8.1 Drain the fuel

1. Turn the 3 in 1 switch to “OFF” ①.

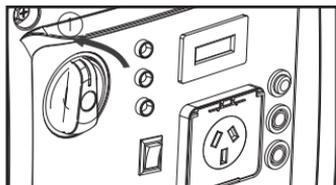

2. Remove the fuel tank cap, remove the filter . Extract the fuel from the fuel tank into an approved petrol container. Then, install the fuel tank cap.



**Fuel is highly flammable and poisonous. Check “SAFETY INFORMATION” (See page 5) carefully.**



**Immediately wipe off spilled fuel with a clean, dry, soft cloth, since fuel may deteriorate painted surfaces or plastic parts.**

3. Start the engine ( See Page 20 ) and leave it run until it stops. The engine stops in approx. 20 minutes. Time by running out of fuel.

**TIP:**

- Do not connect with any electrical devices. (unloaded operation)
  - Duration of the running engine depends on the amount of the fuel left in the tank.
4. Remove the screws, and then remove the cover.
  5. Drain the fuel from the carburetor by loosening the drain screw on the carburetor float chamber.
  6. Turn the 3 in 1 switch to “OFF”.
  7. Tighten the drain screw.
  8. Install the cover and tighten the screws.
  9. Turn the fuel tank cap air vent knob to “OFF” after the engine has completely cooled down.

## **8.2 Engine**

Perform the following steps to protect the cylinder, piston ring, etc. from corrosion.

1. Remove the spark plug, pour about one table- spoon of SAE 15W-40 into the spark plug hole and reinstall the spark plug. Recoil start the engine by turning over several times (with 3 in 1 switch knob off) to coat the cylinder walls with oil.
2. Pull the recoil starter until you feel compression. Then stop pulling. (This prevents the cylinder and valves from rusting).
3. Clean exterior of the generator. Store the generator in a dry, well-ventilated place, with a cover placed over it.

## 9. TROUBLESHOOTING

### 9.1 Engine won't start

#### 1. Fuel systems

No fuel supplied to combustion chamber.

- No fuel in tank...Supply fuel.
- Fuel in tank....Fuel tank cap air vent knob and fuel cock knob to “ON”
- Clogged fuel filter .... Clean fuel filter.
- Clogged carburetor.... Clean carburetor.

#### 2. Engine oil system

Insufficient

- Oil level is low.... Add engine oil.

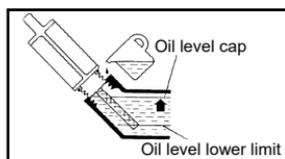

#### 3. Electrical systems

- Put the 3 in 1 switch to “CHOKE” and pull the recoil starter ... Poor spark.
- Spark plug dirty with carbon or wet ... Remove carbon or wipe spark plug dry.
- Faulty ignition system ... consult our company authorized dealer.

### 9.2 Generator won't produce power

- Safety device (DC protector) to “OFF”.... Press the DC protector to “ON”.
- The AC pilot light (Green) go off .... Stop the engine, then restart.

## 10. SPECIFICATIONS

	Model No.	R2500iS
Generator	Type	Inverter
	Rated frequency (Hz)	50
	Rated voltage (V)	230
	Rated output power (kW)	2.3
	Power factor	1
	AC output quality	ISO8528 G2
	voltage (USB) (V)	5±0.3
	Rated output (USB)(A)	1 (The top port)/ 2.1 (The bottom port)
	According to Directive 2000/14/EC and 2005/88/EC Emission sound pressure level:56~68dBA 7m	
Engine	Engine	R120-Vi
	Engine type	Single cylinder, 4-Stroke, forced air cooling, OHV
	Displacement (cc)	122
	Fuel type	Unleaded Petrol
	Fuel tank capacity (L)	4.5
	Continue Running Time (at rated power) (h)	3
	Oil Capacity (L)	0.38
	Spark Model No.	A5RTC
	Starting mode	Recoil starter
Generator set	Length×Width×Height (mm)	520×320×460
	Net weight (kg)	23.5

# 11. WIRING DIAGRAM

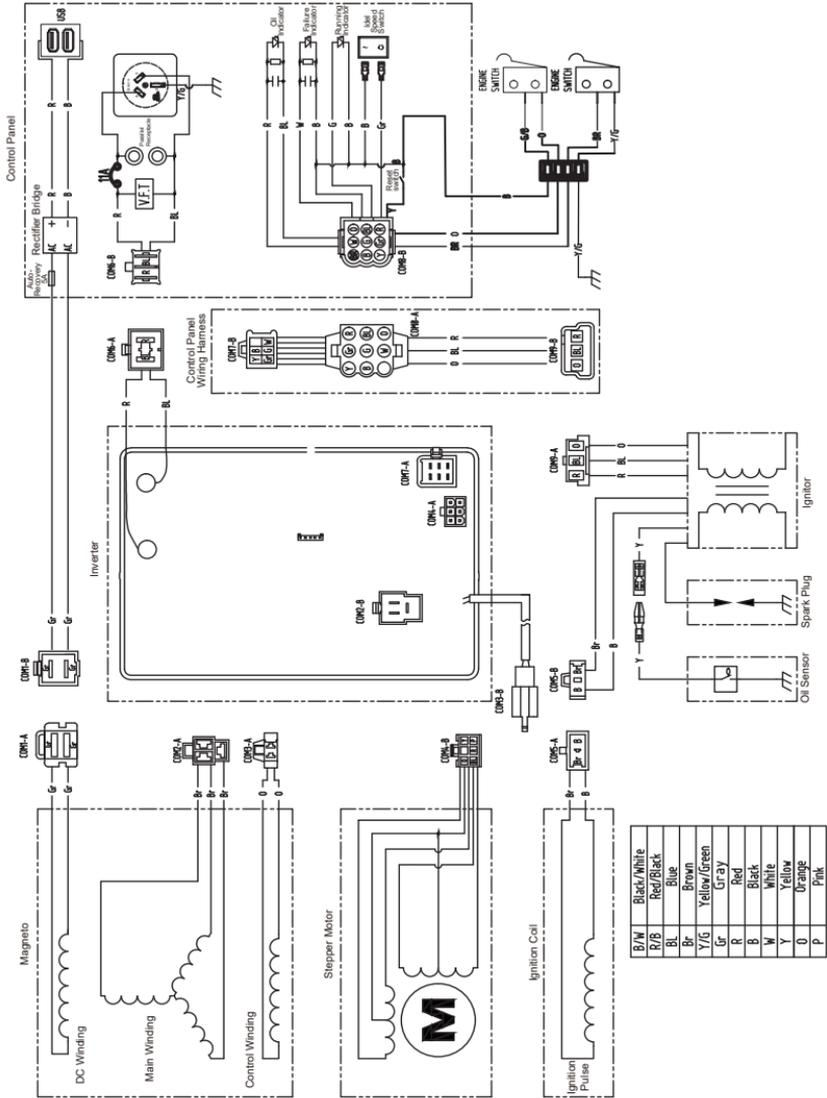

## LIMITED WARRANTY - TERMS & CONDITIONS

Engel Distribution Pty Ltd makes every effort to assure that its products meet high quality and durability standards, and warrants to the original purchaser that this product is free from defects in materials and workmanship for the period of 4 years from the date of purchase for Consumer Use\* or 12 months from the date of purchase for Commercial Use\*\*. This warranty does not apply to damage due directly or indirectly, to misuse, abuse, negligence or accidents, repairs or alterations outside our facilities, criminal activity, improper installation, normal wear and tear, or to lack of maintenance. We shall in no event be liable for death, injuries to persons or property, or for incidental, contingent, special or consequential damages arising from the use of our product. Some states do not allow the exclusion or limitation of incidental or consequential damages, so the above limitation of exclusion may not apply to you. THIS WARRANTY IS EXPRESSLY IN LIEU OF ALL OTHER WARRANTIES, EXPRESS OR IMPLIED, INCLUDING THE WARRANTIES OF MERCHANTABILITY AND FITNESS.

To take advantage of this warranty, the product or part must be returned to us or our nominated agent. Proof of purchase date and an explanation of the complaint must accompany the product or part. If our inspection verifies the defect, we will either repair or replace the product or part at our election. We will return repaired products or parts at our expense, but if we determine there is no defect, or that the defect resulted from causes not within the scope of warranty, then you must bear the cost of returning the product or part.

To ensure prompt and complete warranty coverage, register your product at the website [www.engelaustralia.com.au](http://www.engelaustralia.com.au). A copy of your tax invoice / receipt can be uploaded to our Product Registration portal or you must save your proof of purchase and provide it at the time warranty service is requested.

Consumables such as, but not limited to, oils, coolants, filters and spark plugs shall be the responsibility of the owner.

This warranty gives you specific legal rights and you may also have other rights which vary from state to state.

This warranty will not apply to:

- Any part that has been subjected to misuse, negligence, accidental damage, improper or inadequate maintenance, or improper storage.
- Repair rendered necessary or arising from the use of other than genuine parts.
- Normal maintenance items including but not limited to: adjustment and cleaning of carburettor, fuel strainer, oil and air filter, cables, brake components, intake valves, exhaust valves, clutches and serviceable bearings.
- Normal replacements of service items including but not limited to: spark plugs, air and oil filters, cutting blades, tyres, brake pads, brake shoes, light bulbs, fuses, clutch components and serviceable bearings.
- Deterioration of any item due to normal use, fair wear and tear and exposure unless due to a defect in material or workmanship.
- Damage due to poor servicing or repairs or adjustment performed during servicing or repairs carried out by persons other than Engel Distribution Pty Ltd or its nominated agent / service centre.

- Any damage that results from operating methods other than those indicated in the owner's manual, or use beyond the limitations or specifications as published by Engel Distribution Pty Ltd.
- Products modified from original specifications or fitted with non-genuine parts.
- Modifications such as disconnecting the Low Oil Protection system, Air Cleaner Assembly or Muffler

#### OWNER'S WARRANTY RESPONSIBILITIES

In order to take advantage of the warranty you must follow the servicing frequency as specified in the Owner's Manual supplied with your Engel Generator. The servicing must be carried out by a suitably qualified mechanic and this will not affect your statutory warranties.

As the owner of the product, you are responsible for the performance of the required maintenance listed in your Owner's Manual. Engel Distribution Pty Ltd recommends that you retain all receipts covering maintenance on your product, but Engel Distribution Pty Ltd cannot deny warranty coverage solely for the lack of receipts or for your failure to ensure the performance of all scheduled maintenance.

As the owner of the product, you should however be aware that Engel Distribution Pty Ltd may deny you warranty coverage if your product or part has failed due to abuse (including failure to follow the fuel use instructions contained in this manual), neglect, or improper maintenance or unapproved modifications.

Our goods come with guarantees that cannot be excluded under the Australian Consumer Law. You are entitled to a replacement or refund for a major failure and for compensation for any other reasonably foreseeable loss or damage. You are also entitled to have the goods repaired or replaced if the goods fail to be of acceptable quality and the failure does not amount to a major failure.

You are responsible for presenting your product or part to Engel Distribution Pty Ltd or its nominated agent / service centre as soon as the problem exists in order to obtain warranty repair or replacement. A list of nominated agents / service centres can be found on our website [www.engelaustralia.com.au](http://www.engelaustralia.com.au) under the Support Link, or by calling 1300 302 653, or by emailing [info@engelaustralia.com.au](mailto:info@engelaustralia.com.au). The warranty repairs shall be completed in a reasonable amount of time, not to exceed 30 days. If you have a question regarding your warranty coverage, you should contact Engel Consumer Support at 1300 302 653 or [info@engelaustralia.com.au](mailto:info@engelaustralia.com.au).

Engel Distribution Pty Ltd does not make any representation of any kind to the buyer that he/she is qualified to make any repairs to the product, or that he/she is qualified to replace any parts of the product. In fact, Engel Distribution Pty Ltd expressly states that all repairs and parts replacements should be undertaken by certified and licensed technicians, and not by the buyer. The buyer assumes all risk and liability arising out of his/her repairs to the original product or replacement parts thereto, or arising out of his/her installation of replacement parts thereto.

**\*Consumer Use means:** Personal, Residential or Household use only by a consumer.

**\*\*Commercial Use means:** All uses other than consumer use, including use for commercial, income producing or rental purposes. Once a product has been used for commercial use, it shall thereafter be considered as a commercial use product for purposes of this warranty.





